

0222-2 Queen Bed

Assembly Instructions

WI-0723

1 Assembled View

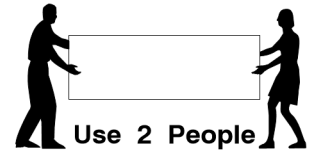
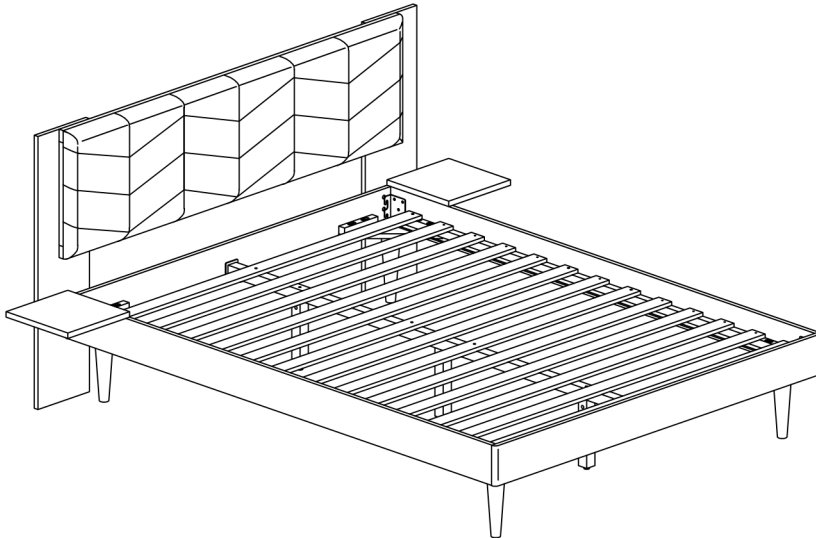

Note: Do not assemble using power tools. This can cause the bolts to be overtightened

2 Parts List

Parts in Box A:

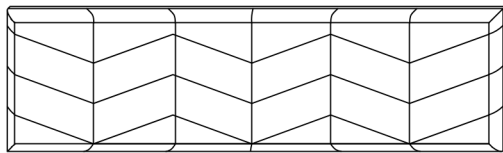

A Headboard Panel x 1

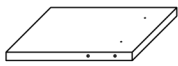

B Shelf Panel (Left Hand) x 1

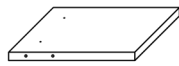

C Shelf Panel (Right Hand) x 1

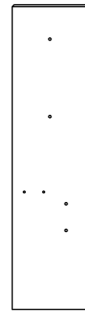

D Headboard Side Panel (Left Hand) x 1



E Headboard Side Panel (Right Hand) x 1



F Post x 4

Parts in Box B:

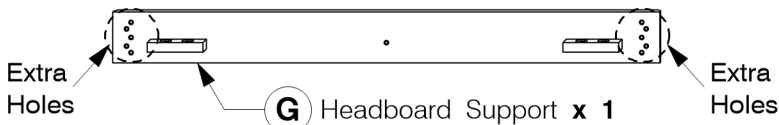

G Headboard Support x 1

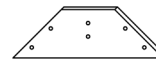

L Support Panel x 4



M Support Leg x 3



H Footboard Support x 1



J Side Rail x 2

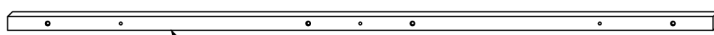

K Long Support x 1

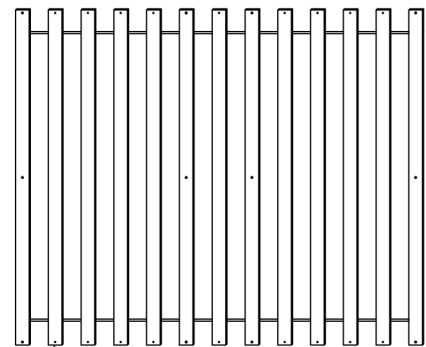

N Set of Bed Slats x 1

0222-2 Queen Bed

Assembly Instructions

WI-0723

3 Hardware List



1 M4 Allen Key
x 1



2 M5 Allen Key
x 1

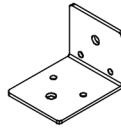

3 Center Rail
Bracket x 2

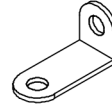

4 'L' Bracket
(5003) x 4

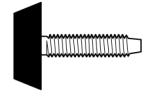

5 Adjustable
Foot x 3



6 Barrel Nut
x 3



7 Spring Washer
x 32



8 Flat Washer
x 32



9 Wood Screw
(M4 x 16mm)
x 8

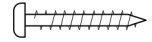

10 Wood Screw
(M4 x 32mm)
x 18

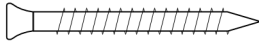

11 CSK Cap Wood Screw
(M6 x 50mm) x 4

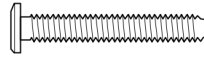

12 M8 x 50mm JCB
x 8



13 M6 x 15mm JCB
x 4

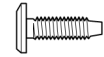

14 M6 x 20mm JCB
x 8



15 M6 x 35mm JCB
x 4



16 M6 x 40mm JCB
x 16



17 M6 x 50mm JCB
x 16



18 M6 x 90mm JCB
x 3

4 Fit the Center Rail Bracket to the Footboard Support (H).

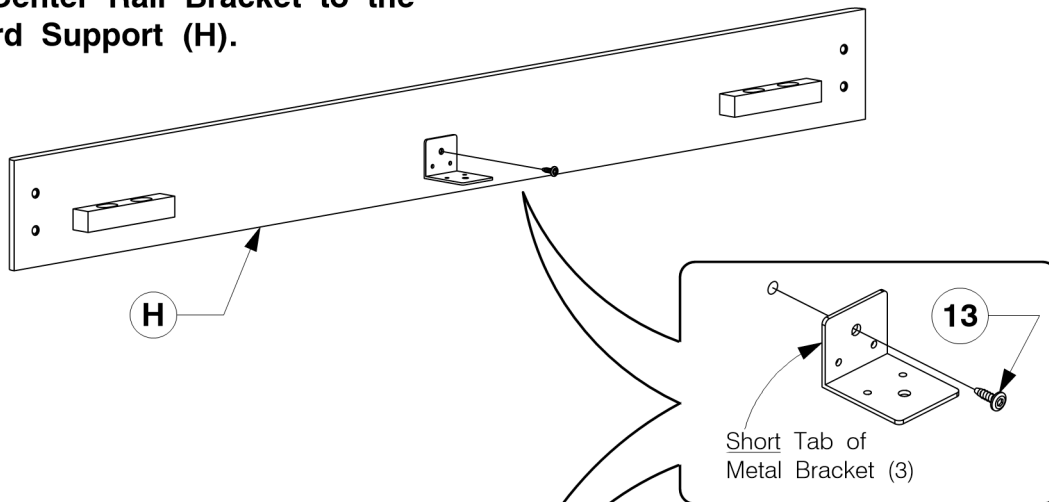

5 Fit the Center Rail Bracket to the Headboard Support (G).

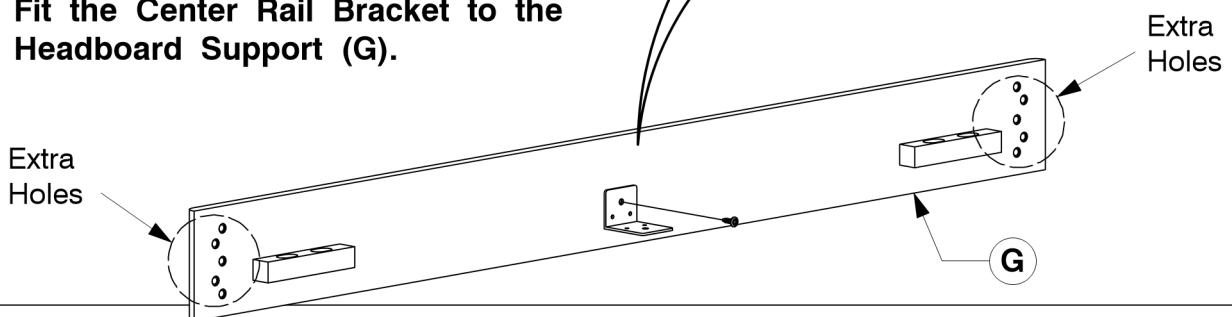

0222-2 Queen Bed

Assembly Instructions

WI-0723

- 6** Assembled the Support Legs (M) to the Long Support (K).

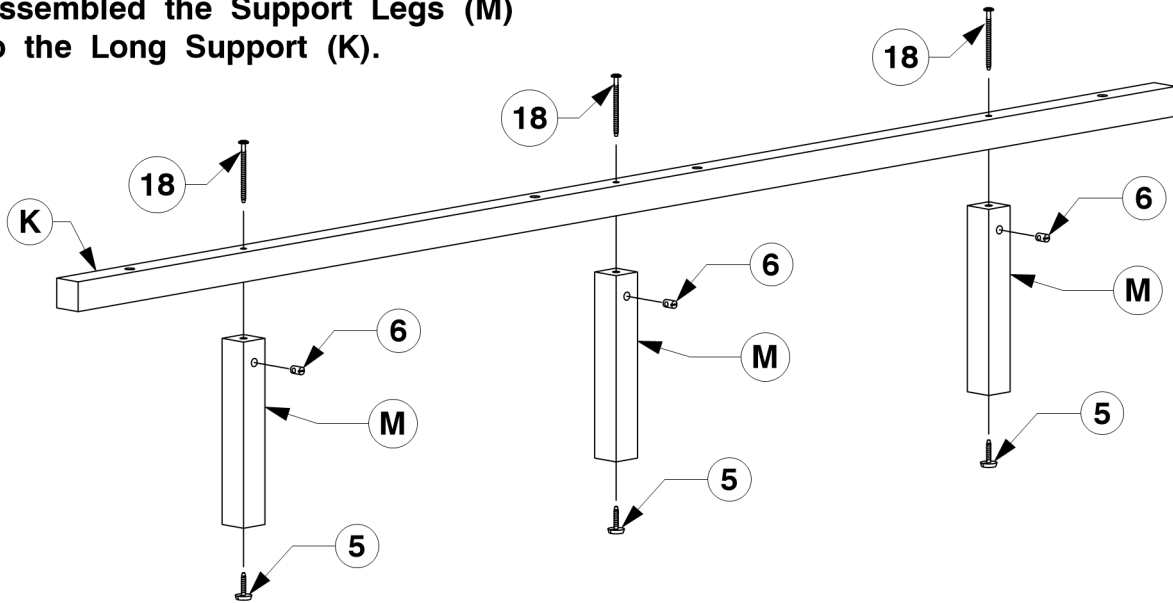

- 7** Fit the Post (F) to the Support Panel (L).

(x4)

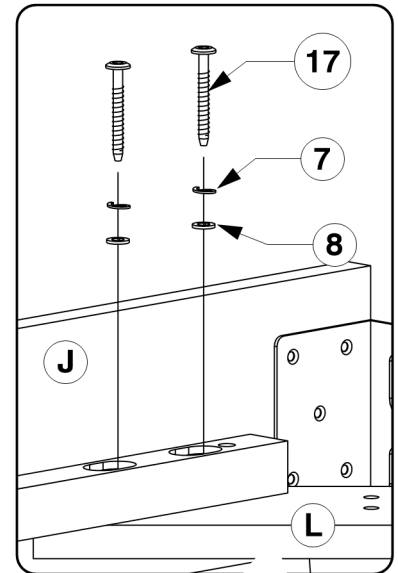
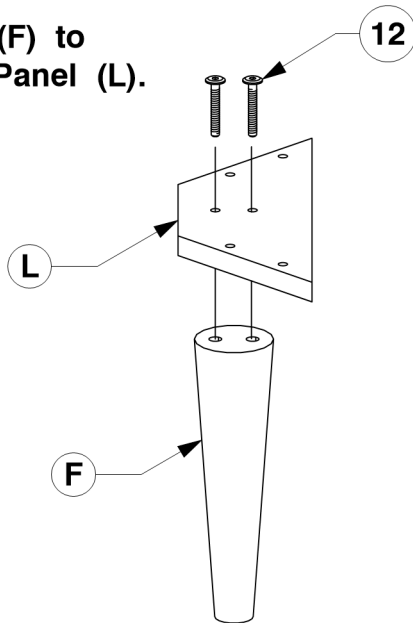

- 8** Bolt the assembled Support Panel (L) to the Side Rail (J).

(x2)

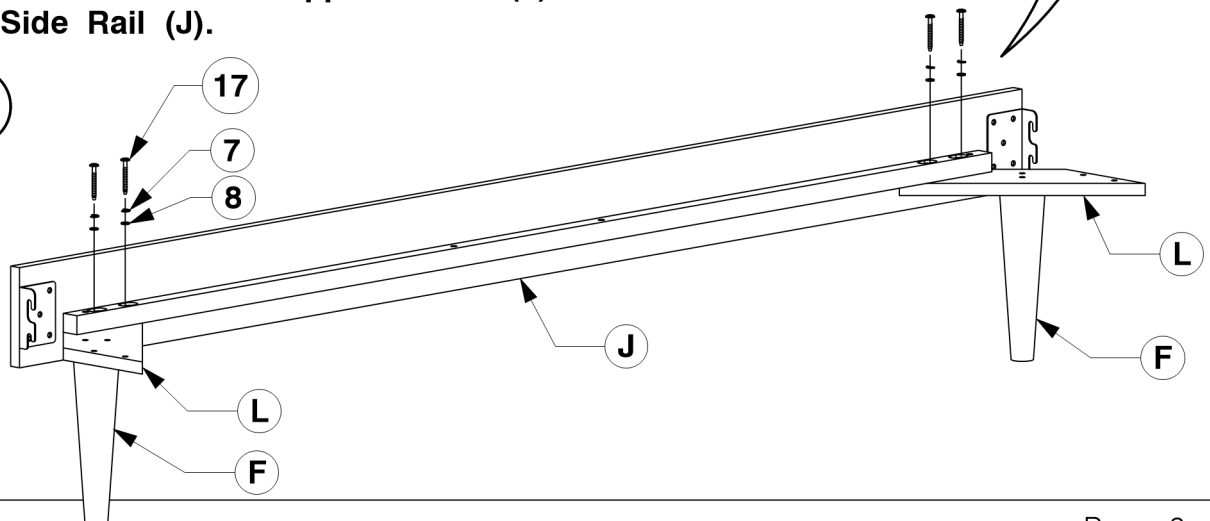

0222-2 Queen Bed

Assembly Instructions

WI-0723

9 Fit the 'L' Bracket to the Shelf Panels (B & C).

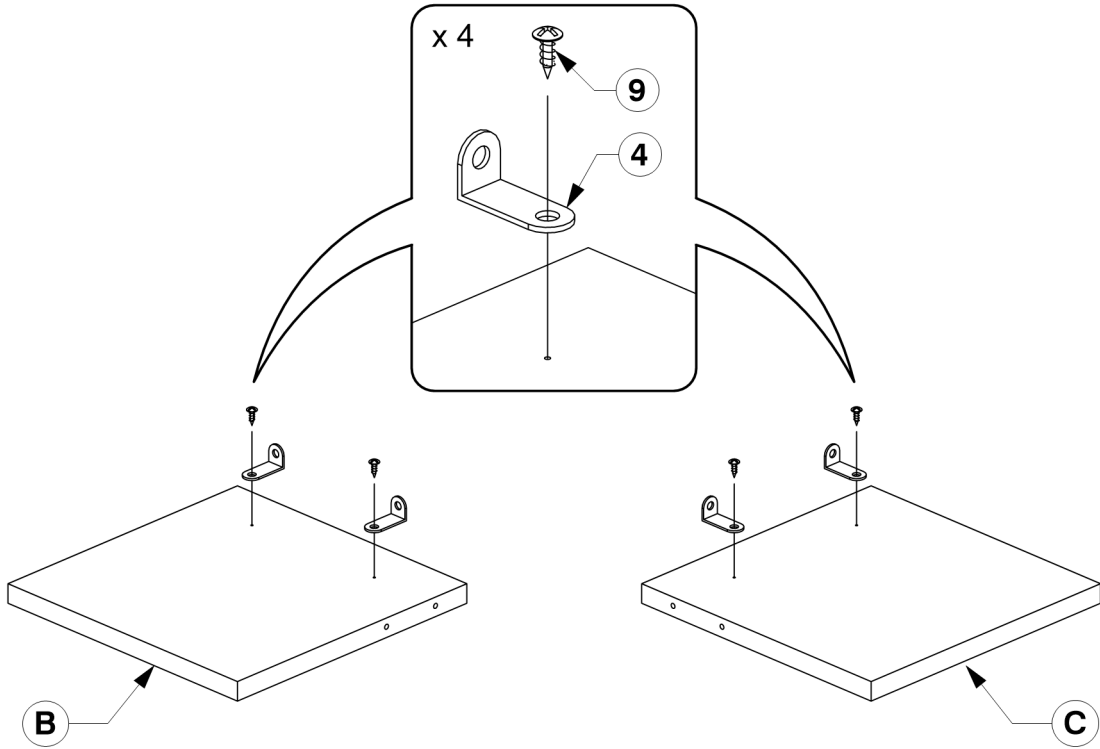

10 Assemble the Headboard Side Panels (D & E) to the Headboard Panel (A).

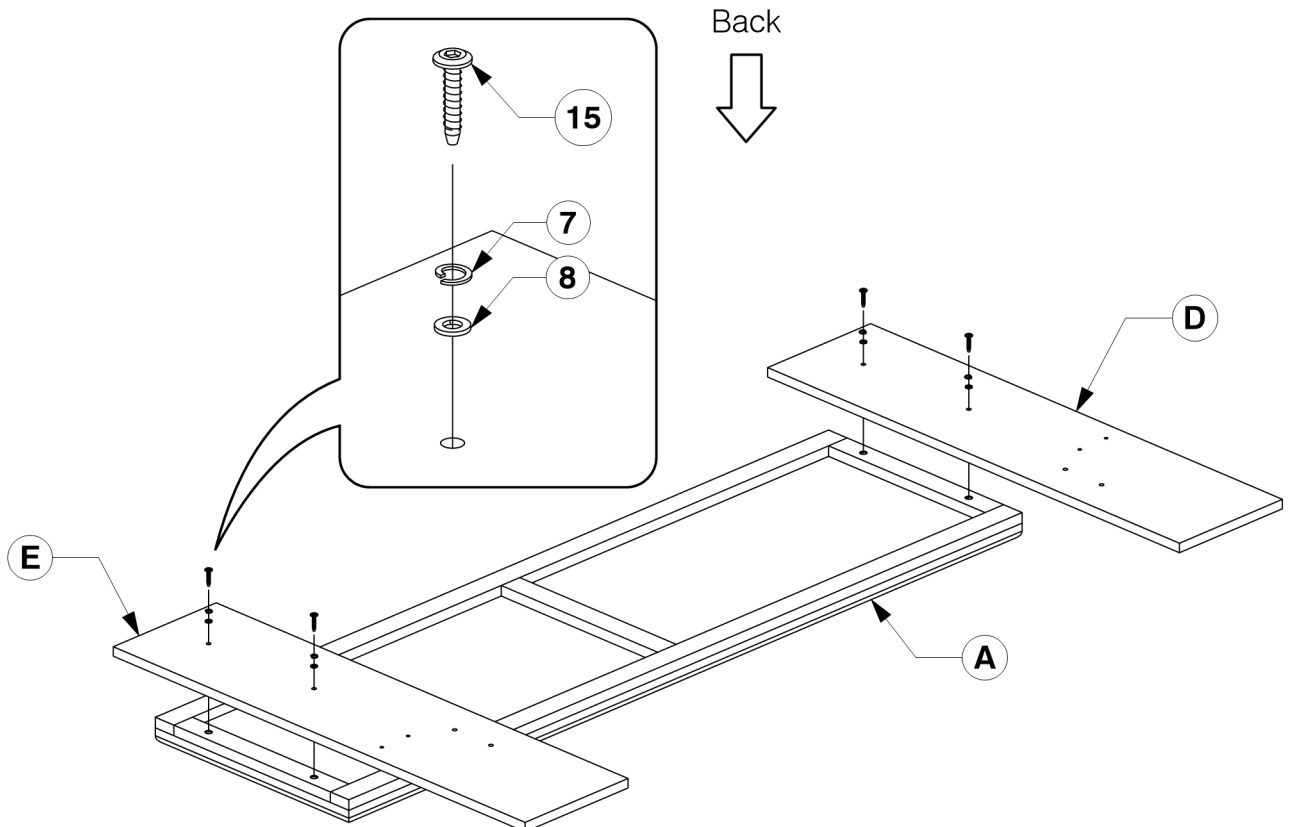

0222-2 Queen Bed

Assembly Instructions

WI-0723

- 11** Assemble the Headboard & Footboard Support (G & H) to the assembled Side Rails (J).

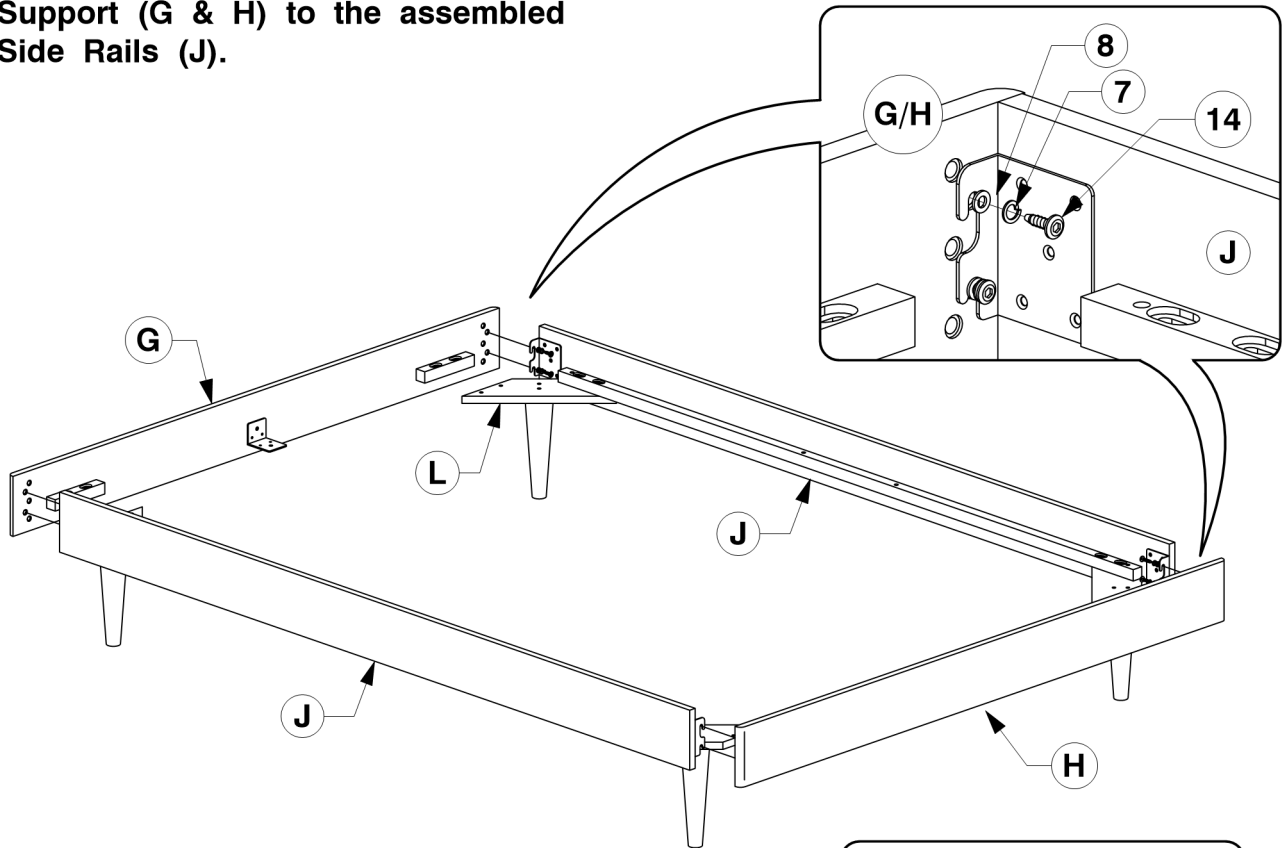

- 12** Bolt the Support Panels (L) to the Headboard & Footboard Support (G & H).

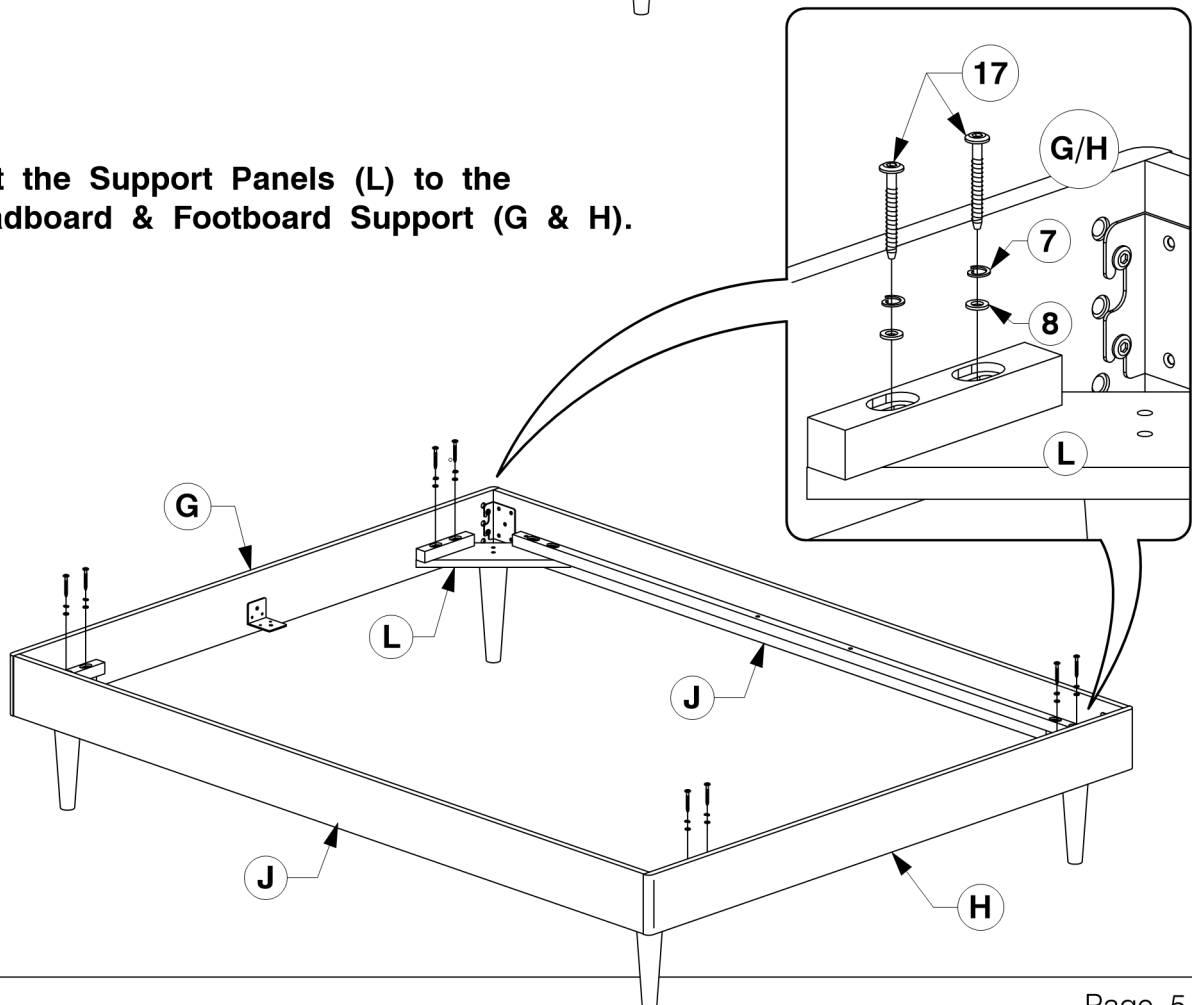

0222-2 Queen Bed

Assembly Instructions

WI-0723

- 13** Bolt the Long Support (K) to the Center Rail Brackets (3) on the Headboard & Footboard Support (G & H).

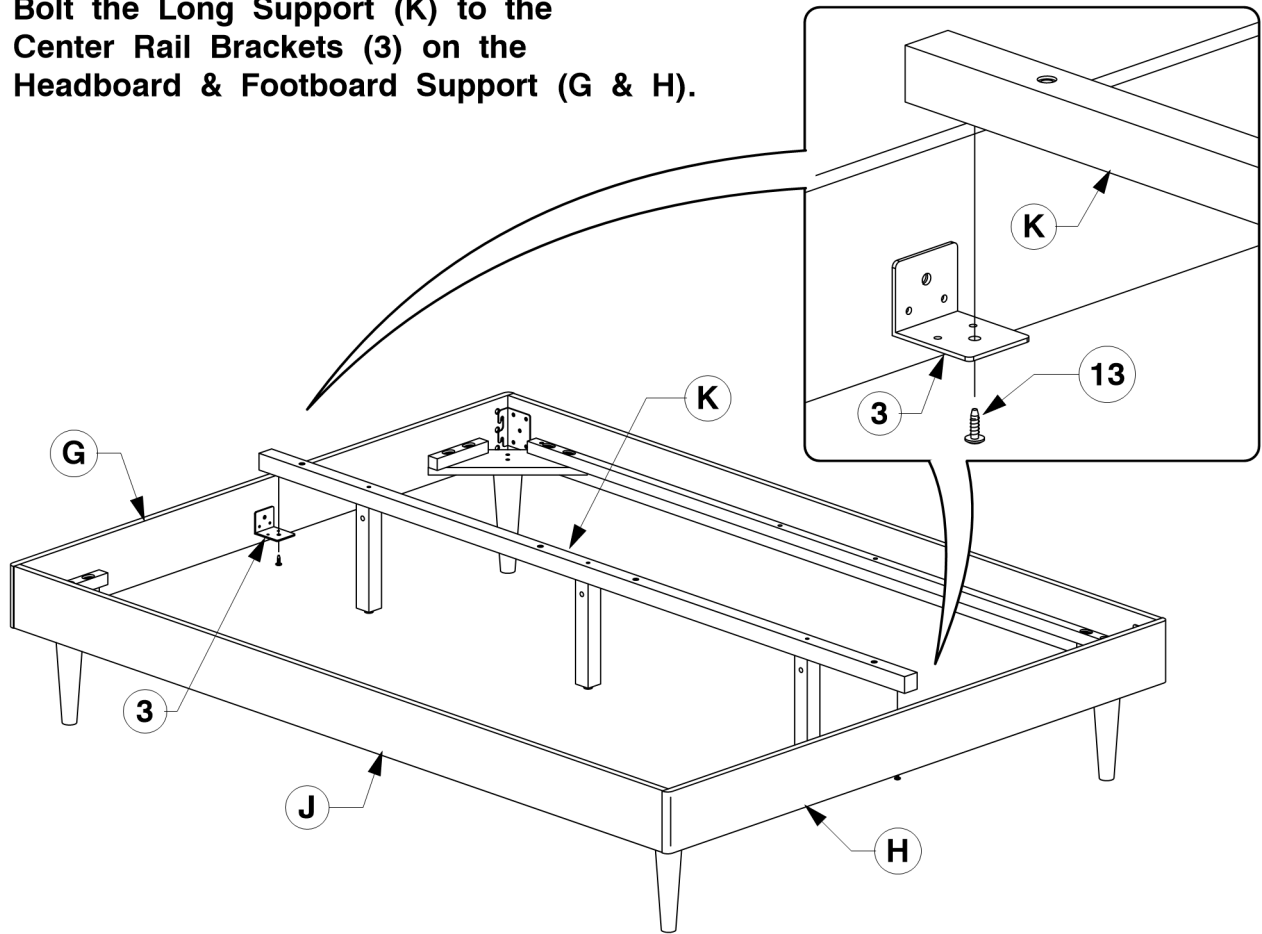

- 14** Bolt the Bed Slats (N) to the Side Rails (J).

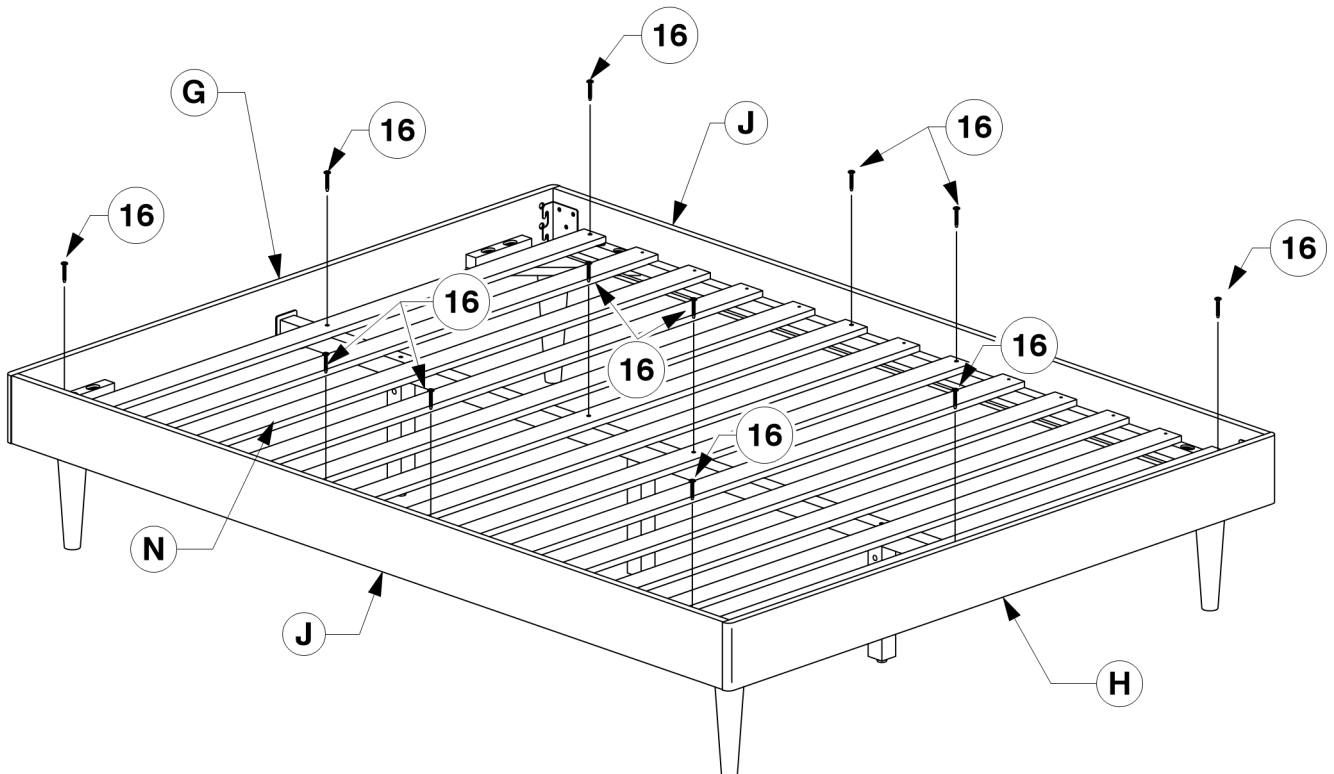

0222-2 Queen Bed

Assembly Instructions

WI-0723

- 15** Screw the Bed Slats (N) to the Side Rails (J).

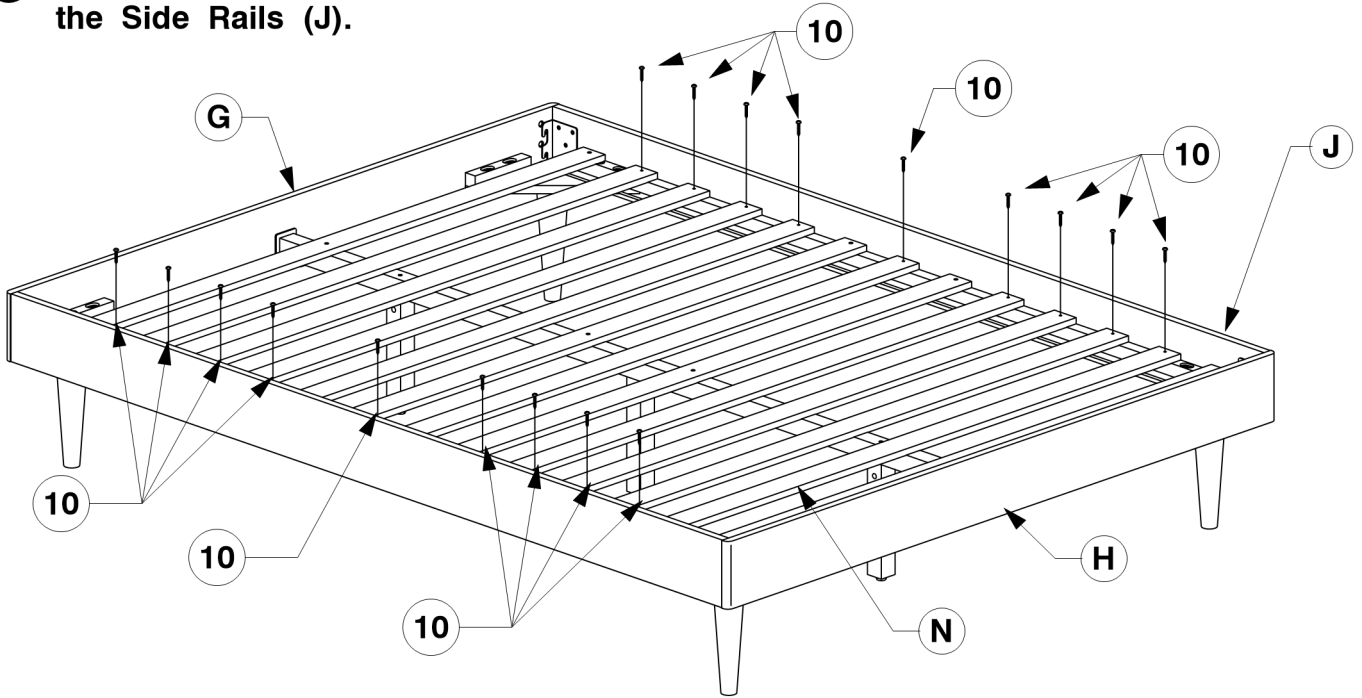

- 16** Assemble the Headboard Side Panels (D & E) to the Headboard Support (G).

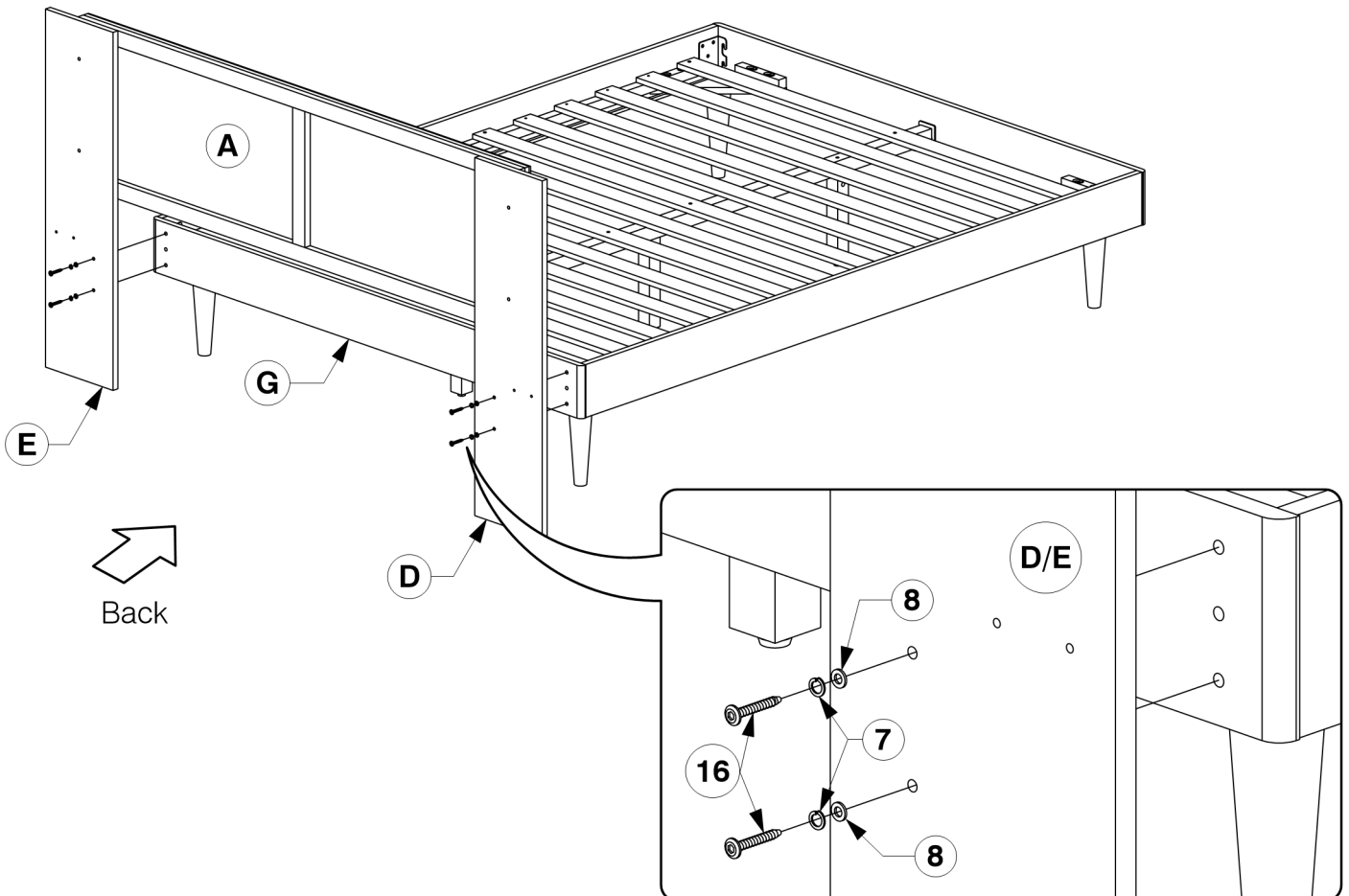

0222-2 Queen Bed

Assembly Instructions

WI-0723

- 17** Fit the Shelf Panels (B & C) to the Headboard Side Panels (D & E).

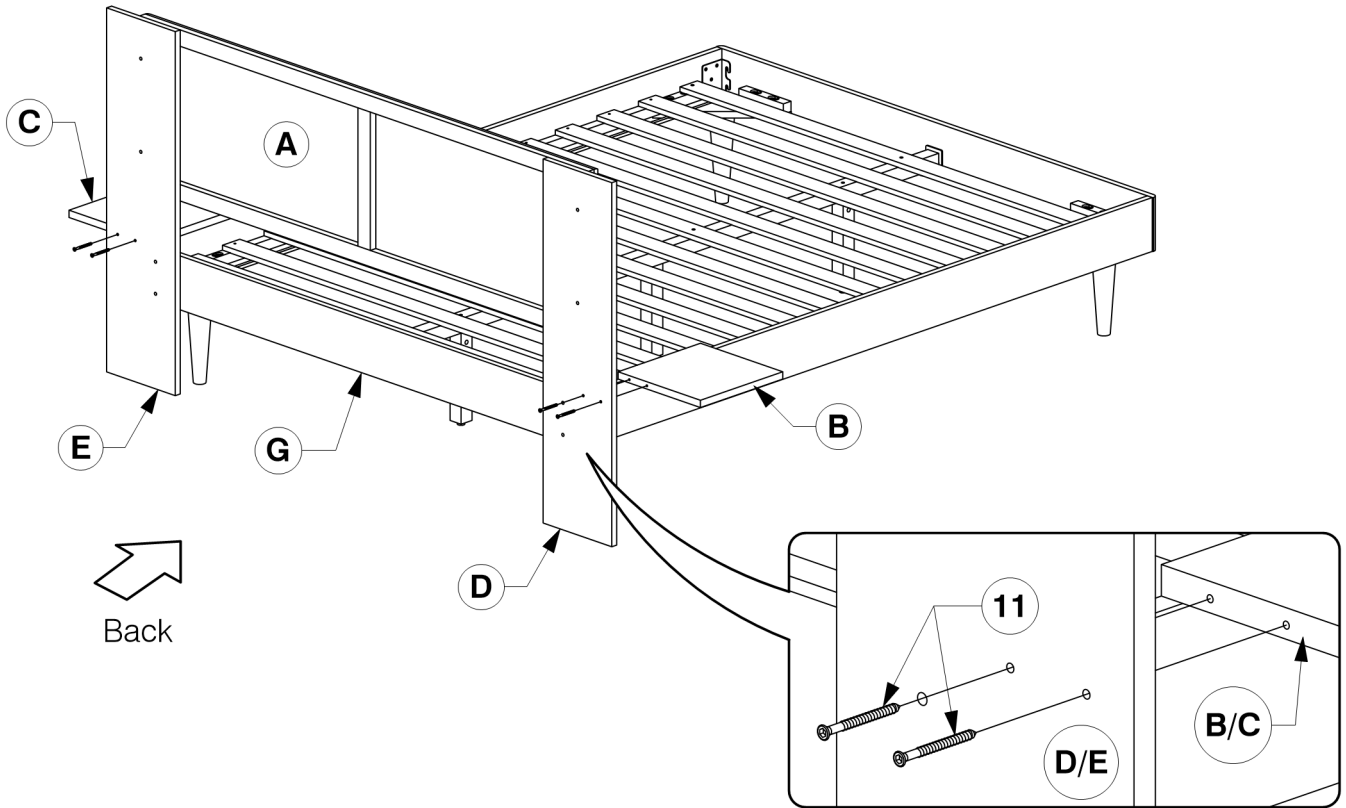

- 18** Tighten the Shelf Panels (B & C) with screws on both sides.

