

# 0058 Full Bed

## Assembly Instructions

WI-1220

### 1 Assembled View

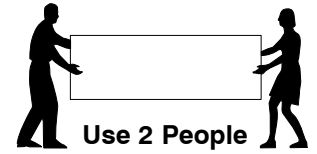
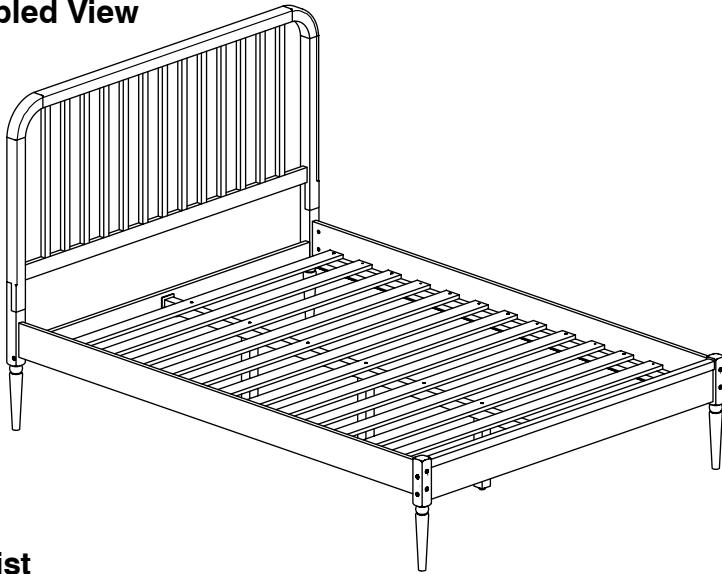

**Note:** Do not assemble using power tools. This can cause the bolts to be overtightened

### 2 Parts List

#### Parts in Box A:

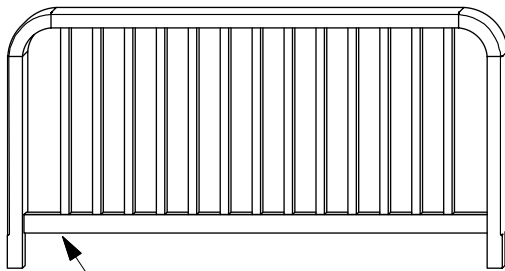

**A** Headboard Panel x 1

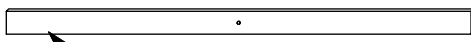

**B** Headboard Support x 1

**C**  
Headboard Post (Left Hand) x 1

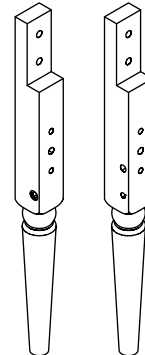

**D**  
Headboard Post (Right Hand) x 1

#### Parts in Box B:



**E** Footboard Panel x 1



**F** Side Rail x 2

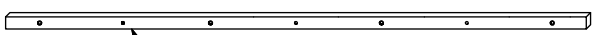

**G** Long Support x 1

**H**  
Footboard Post (Left Hand) x 1

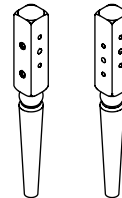

**J**  
Footboard Post (Right Hand) x 1



**K**  
Support Leg x 3

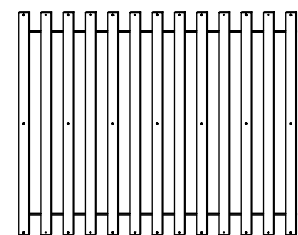

**L** Set of Bed Slats x 1

# 0058 Full Bed

## Assembly Instructions

WI-1220

### 3 Hardware List



1 M4 Allen Key  
x 1

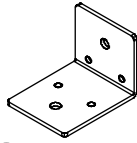

2 Center Rail  
Bracket x 2

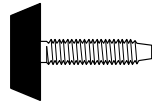

3 Adjustable  
Foot x 3



4 Barrel Nut  
x 17

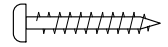

5 Wood Screw  
(M4 x 32mm)  
x 12



6 Wood Dowel  
(10 x 40mm)  
x 8



7 Spring  
Washer  
x 4



8 Flat  
Washer  
x 4



9 M6 x  
15mm JCB  
x 4



10 M6 x  
40mm JCB  
x 22



11 M6 x 90mm JCB  
x 14



12 M6 x 100mm JCB  
x 3

### 4 Fix the Adjustable foot to the bottom of the Support Leg (K).

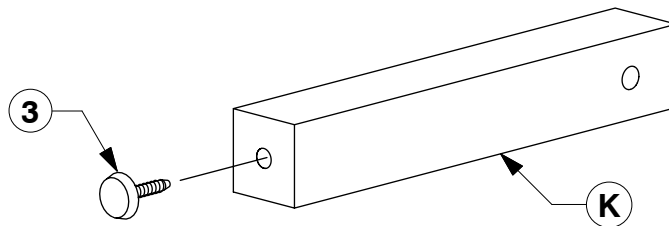

### 5 Fit the Footboard Panel (E) to the Footboard Post (H & J). Fit the Center Rail Bracket to the Footboard Panel (E).

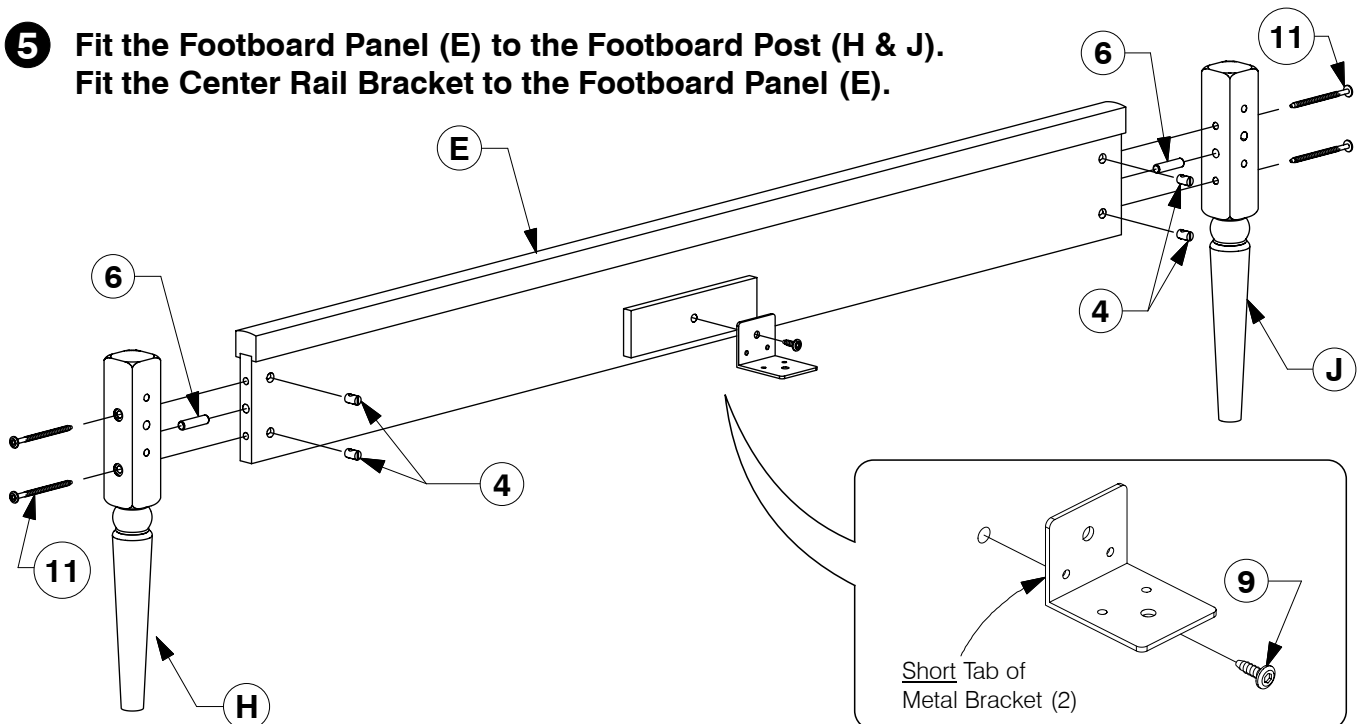

# 0058 Full Bed

## Assembly Instructions

WI-1220

- 6** Fit the Headboard Support (B) to the Headboard Post (C & D).  
Fit the Center Rail Bracket to the Headboard Support (B).

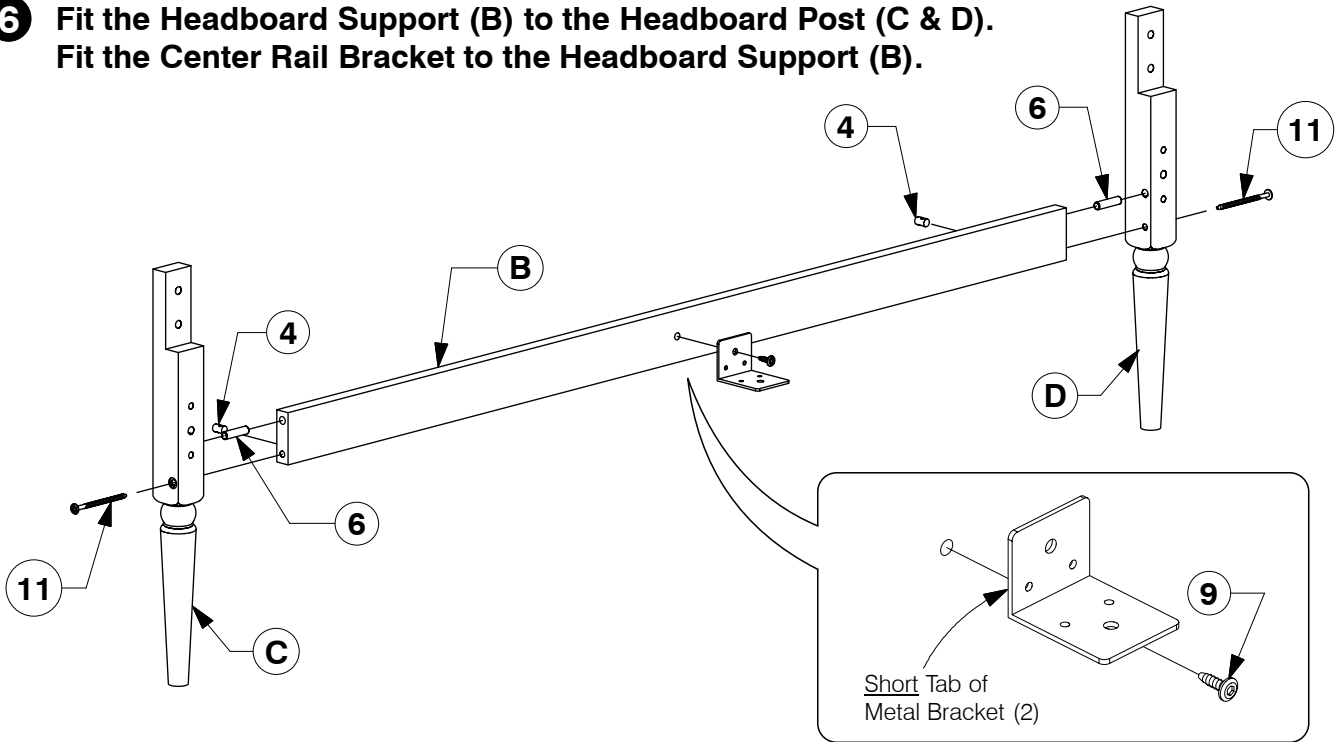

- 7** Assemble the Headboard Panel (A) to the Headboard Post (C & D).

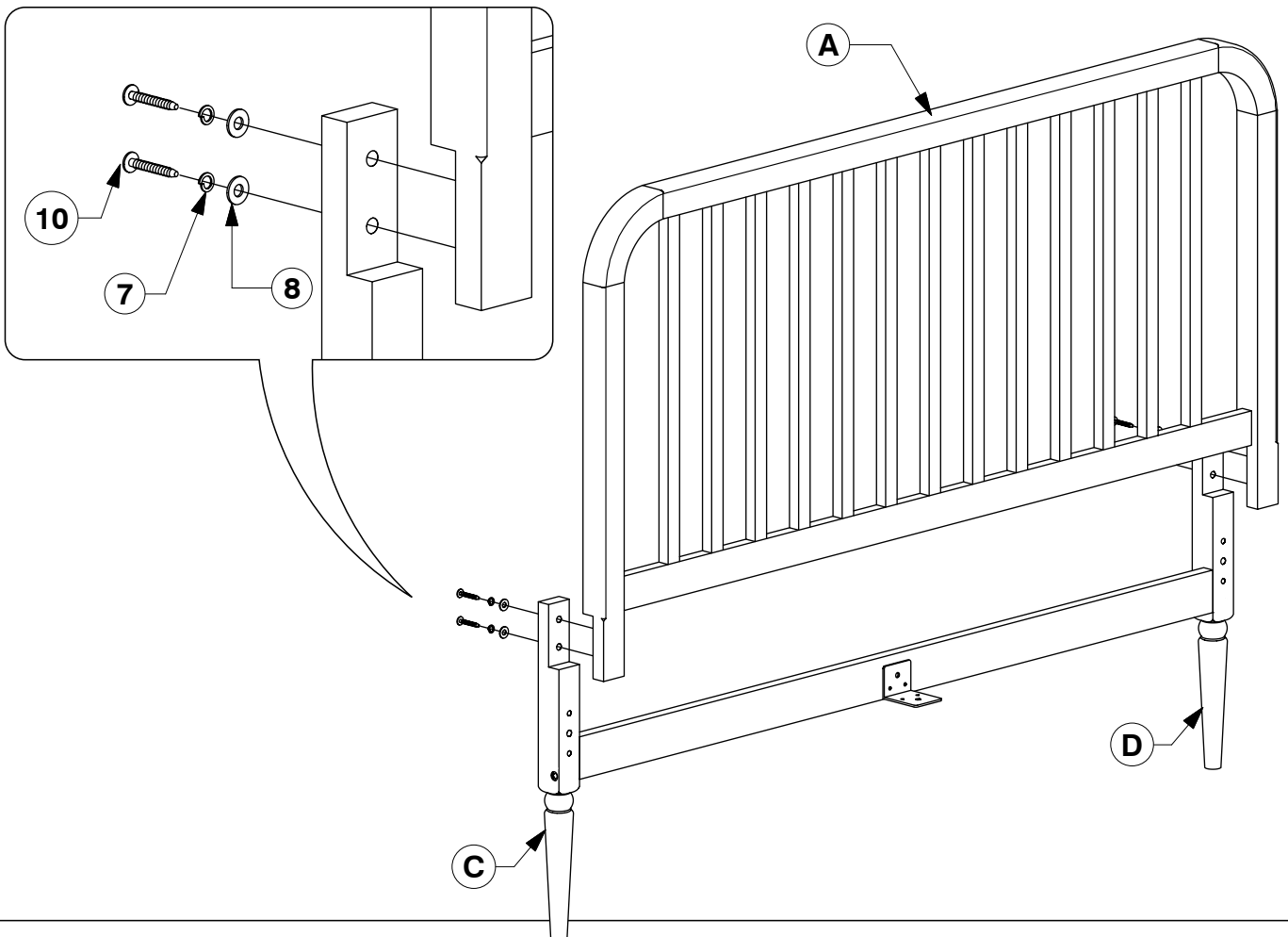

# 0058 Full Bed

## Assembly Instructions

WI-1220

### 8 Assemble the Side Rail (F) to the Headboard & Footboard.

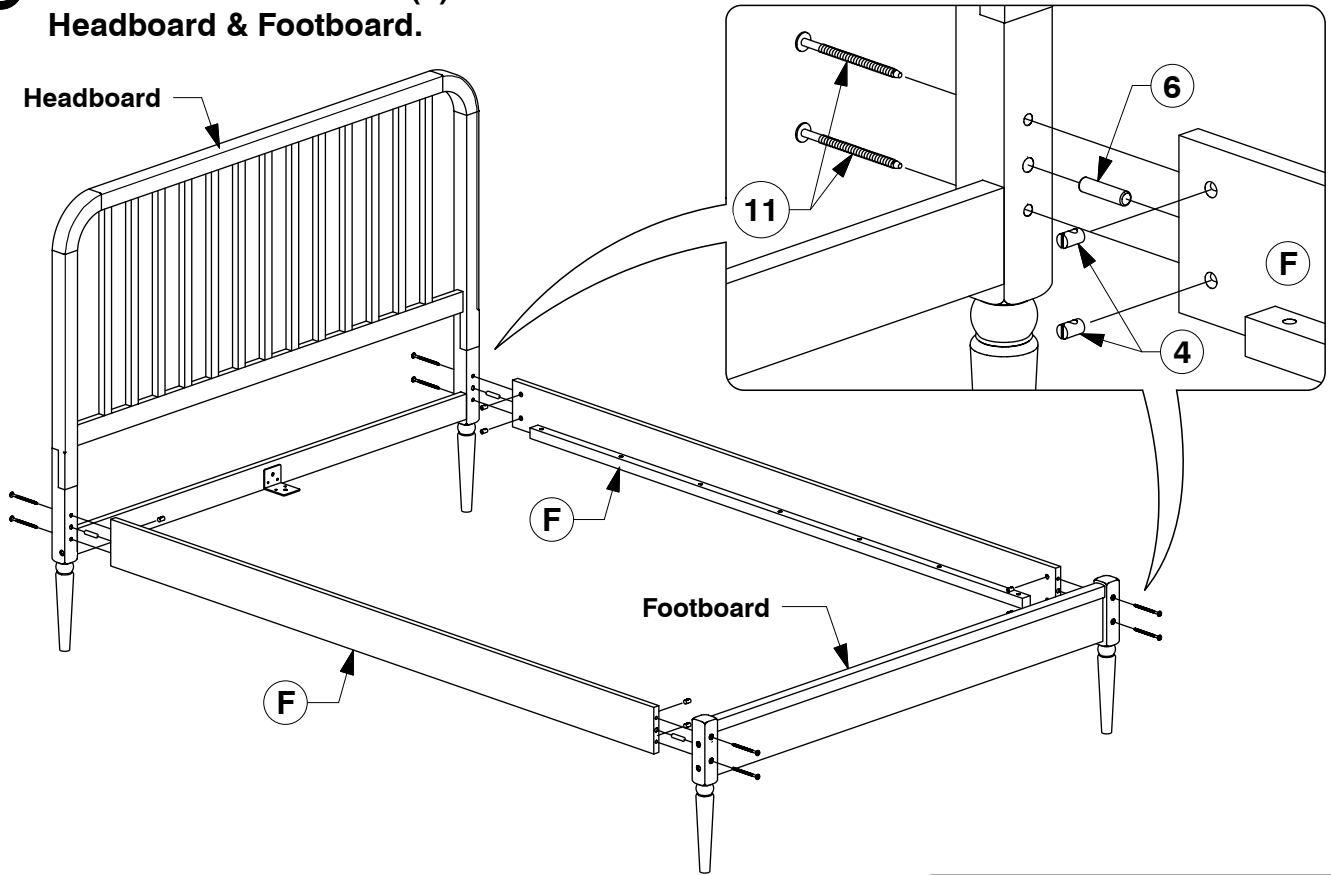

### 9 Bolt the Long Support (G) to the Center Rail Brackets (2) on the Headboard / Footboard.

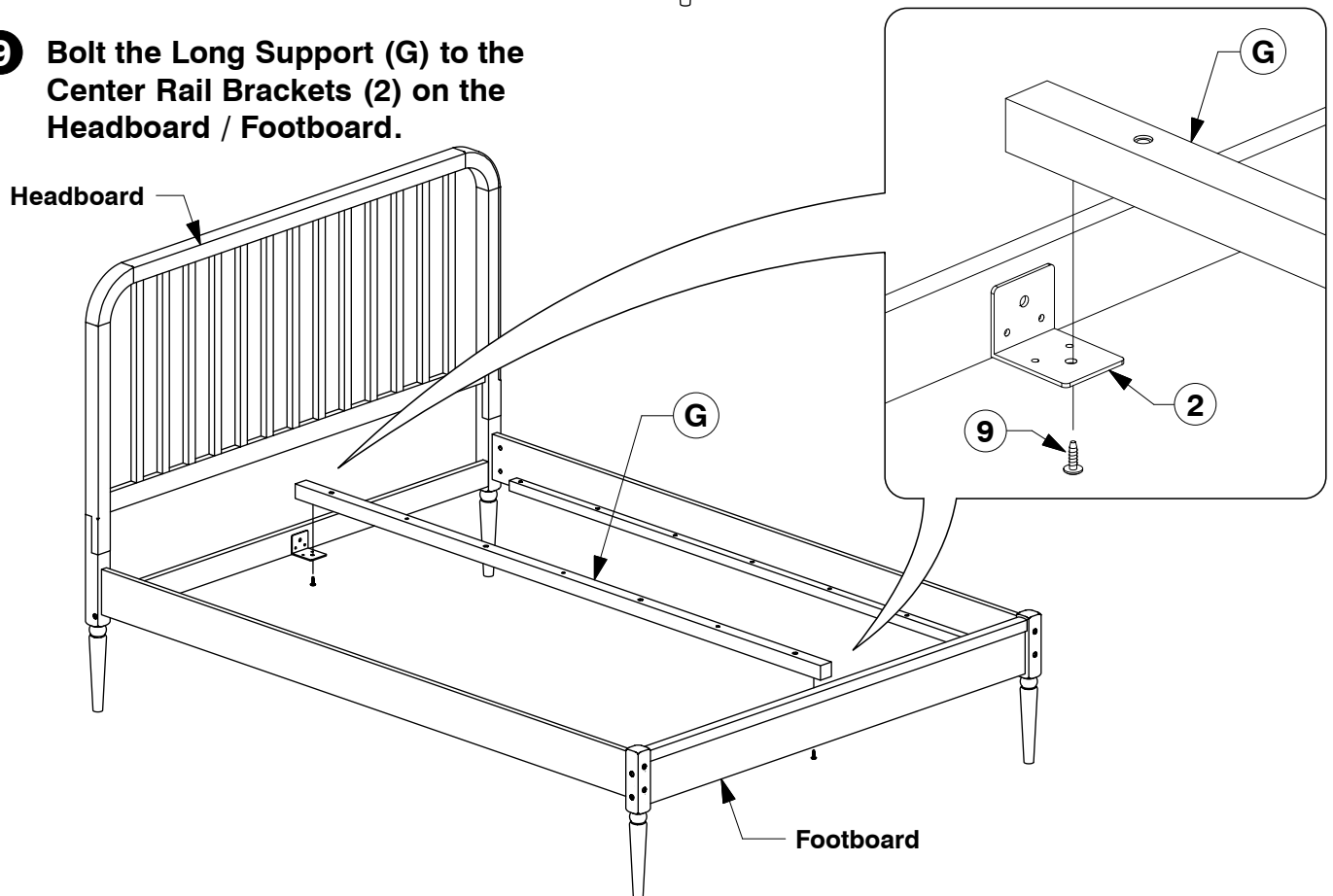

# 0058 Full Bed

## Assembly Instructions

WI-1220

- 10** Fit the first 3 Slats and assemble the Support Leg (K) to the Bed Slat (L). Bolt & screw the Bed Slats (L) to the Side Rail (F) & Long Support (G).

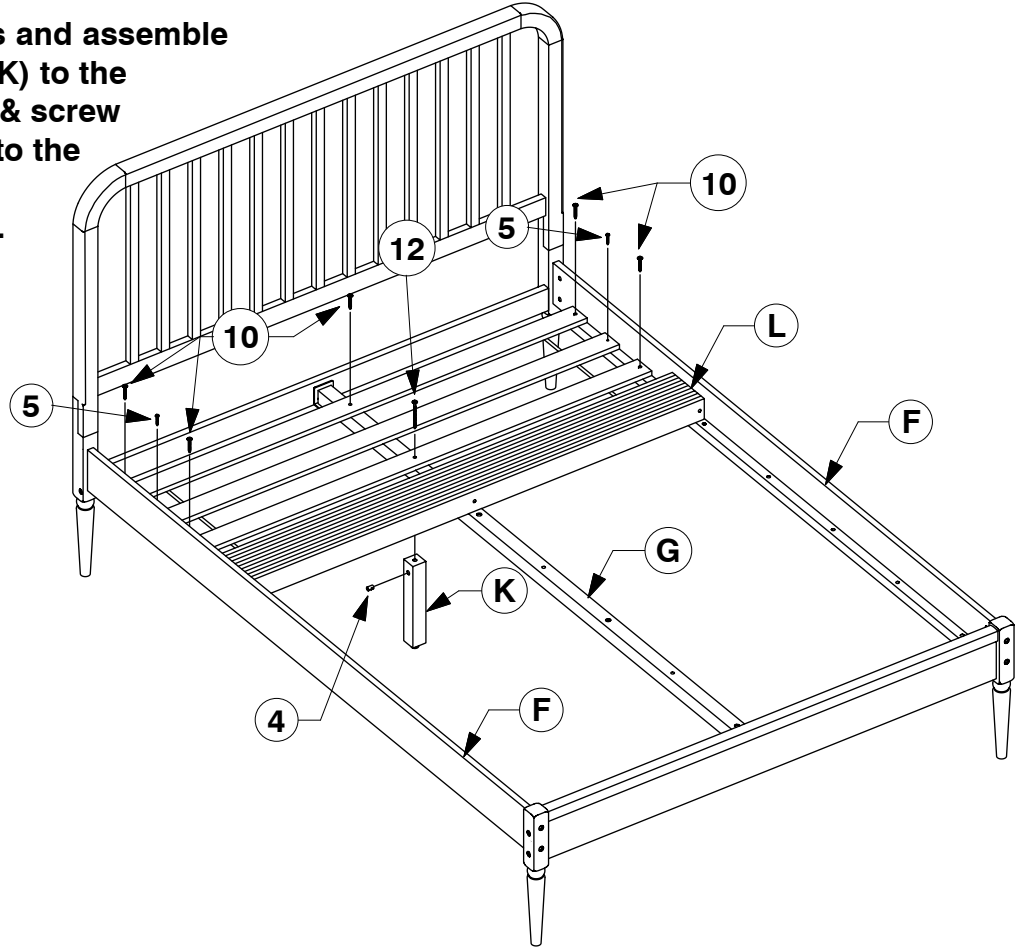

- 11** Fit the other Slats out and assemble the Support Leg (K) to the Bed Slat (L). Bolt & screw the Bed Slats (L) to the Side Rail (F) & Long Support (G).

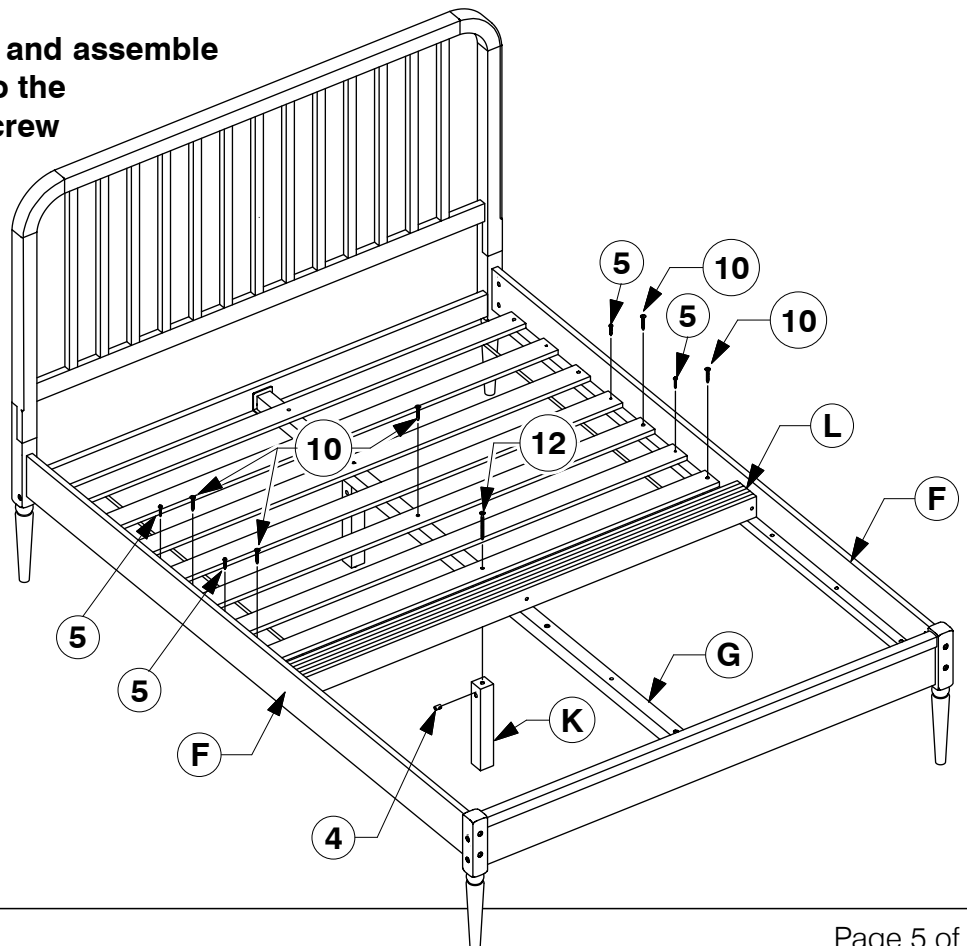

# 0058 Full Bed

## Assembly Instructions

WI-1220

- 12** Fit the other Slats out and assemble the Support Leg (K) to the Bed Slat (L). Bolt & screw the Bed Slats (L) to the Side Rail (F) & Long Support (G).

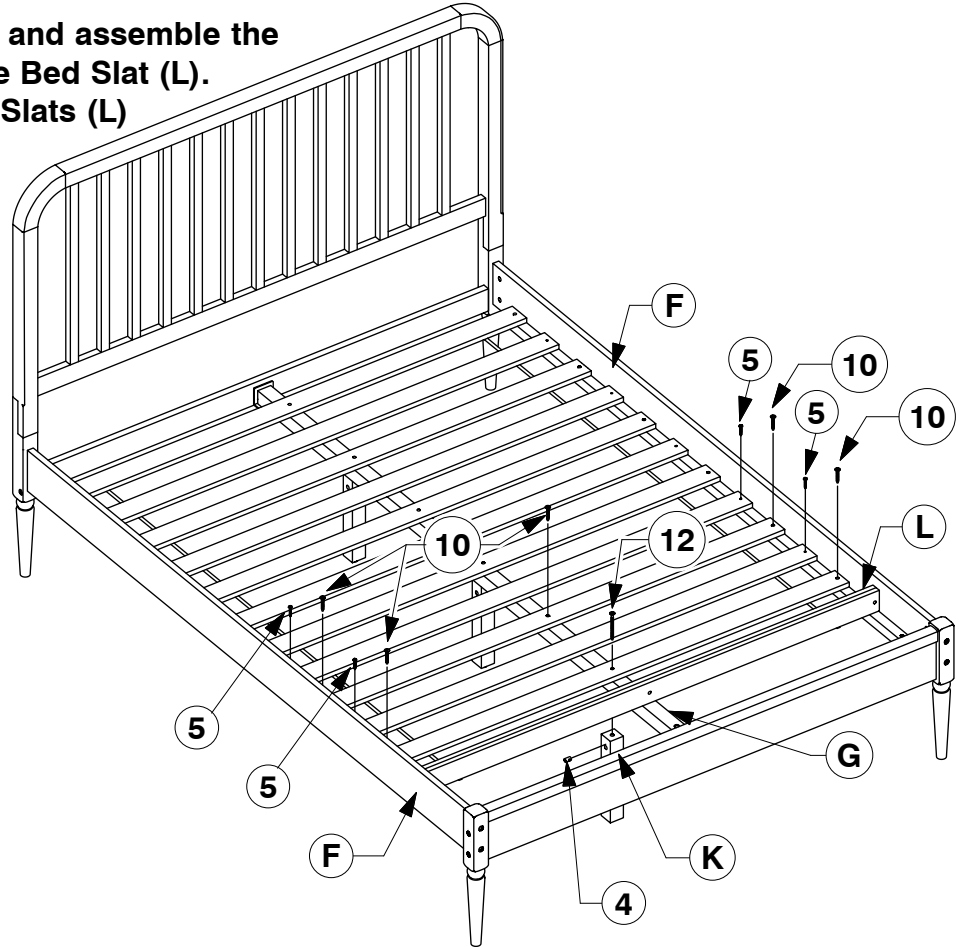

- 13** Bolt & screw the remaining Bed Slats (L) to the Side Rail (F).

