

# 0056 Queen Bed

## Assembly Instructions

WI-1220

### 1 Assembled View

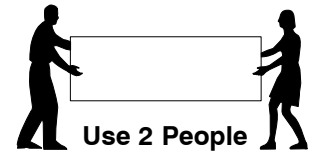
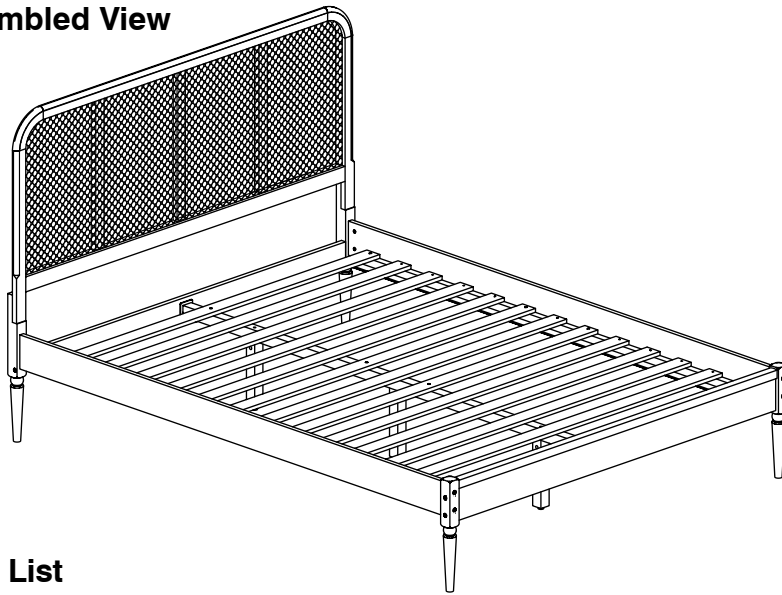

**Note:** Do not assemble using power tools. This can cause the bolts to be overtightened

### 2 Parts List

#### Parts in Box A:

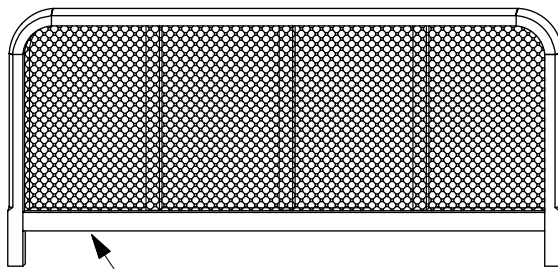

**A** Headboard Panel x 1

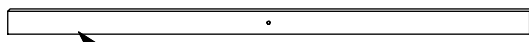

**B** Headboard Support x 1

**C**  
Headboard Post (Left Hand) x 1

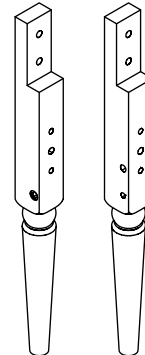

**D**  
Headboard Post (Right Hand) x 1

#### Parts in Box B:



**E** Footboard Panel x 1



**F** Side Rail x 2

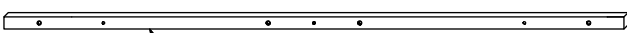

**G** Long Support x 1

**H**  
Footboard Post (Left Hand) x 1

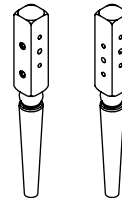

**J**  
Footboard Post (Right Hand) x 1



**K**  
Support Leg x 3

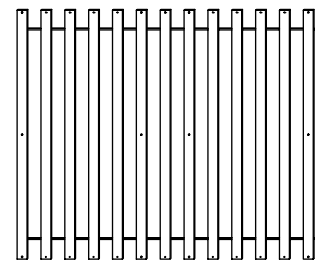

**L** Set of Bed Slats x 1

# 0056 Queen Bed

## Assembly Instructions

WI-1220

### 3 Hardware List

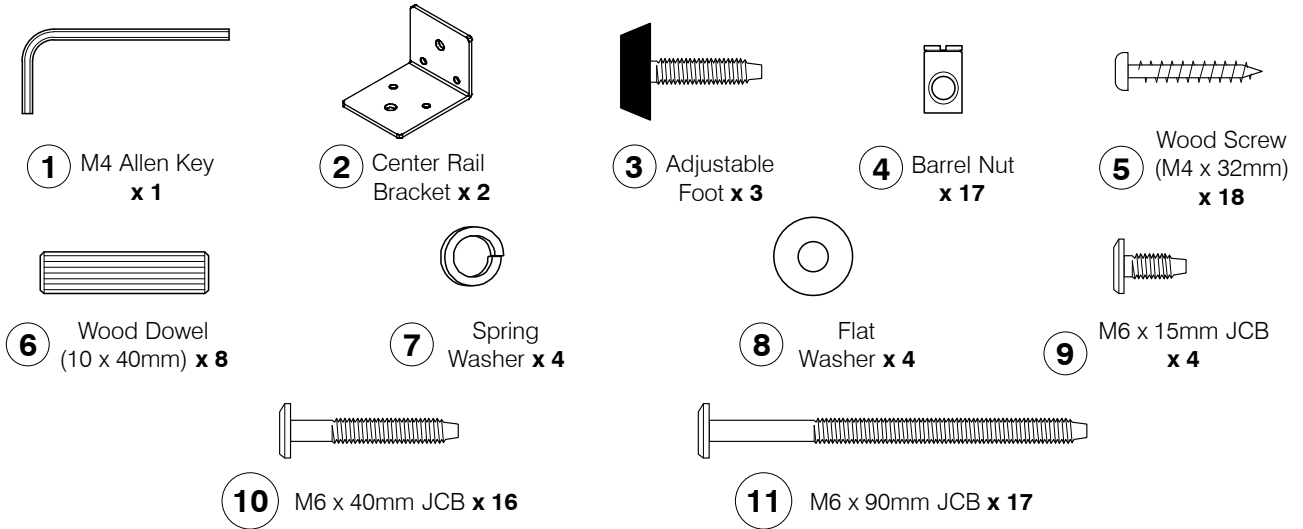

### 4 Assembled the Support Leg (K) to the Long Support (G).

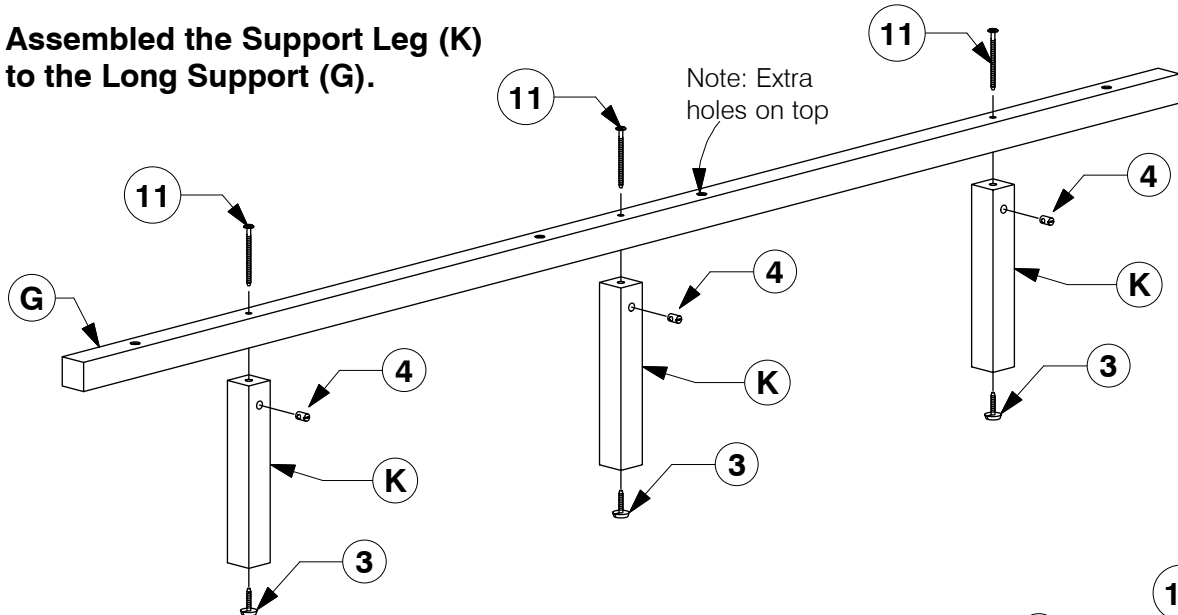

### 5 Fit the Footboard Panel (E) to the Footboard Post (H & J). Fit the Center Rail Bracket to the Footboard Panel (E).

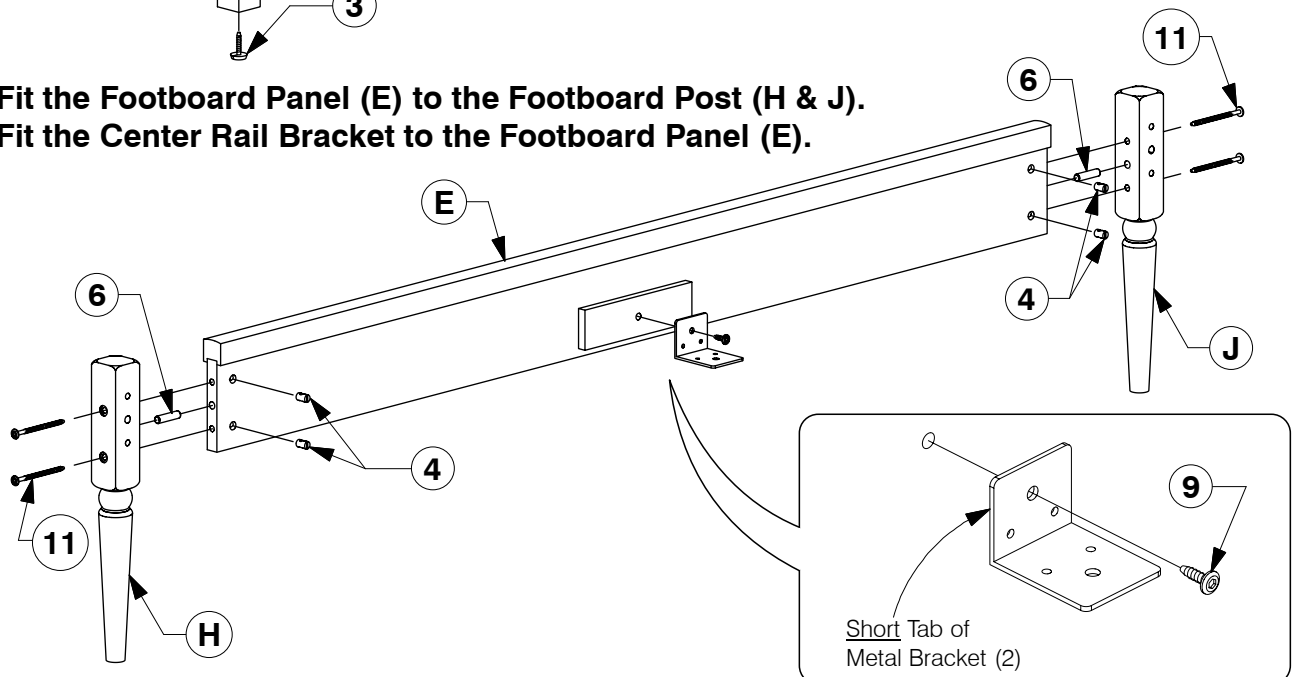

# 0056 Queen Bed

## Assembly Instructions

WI-1220

- 6** Fit the Headboard Support (B) to the Headboard Post (C & D).  
Fit the Center Rail Bracket to the Headboard Support (B).

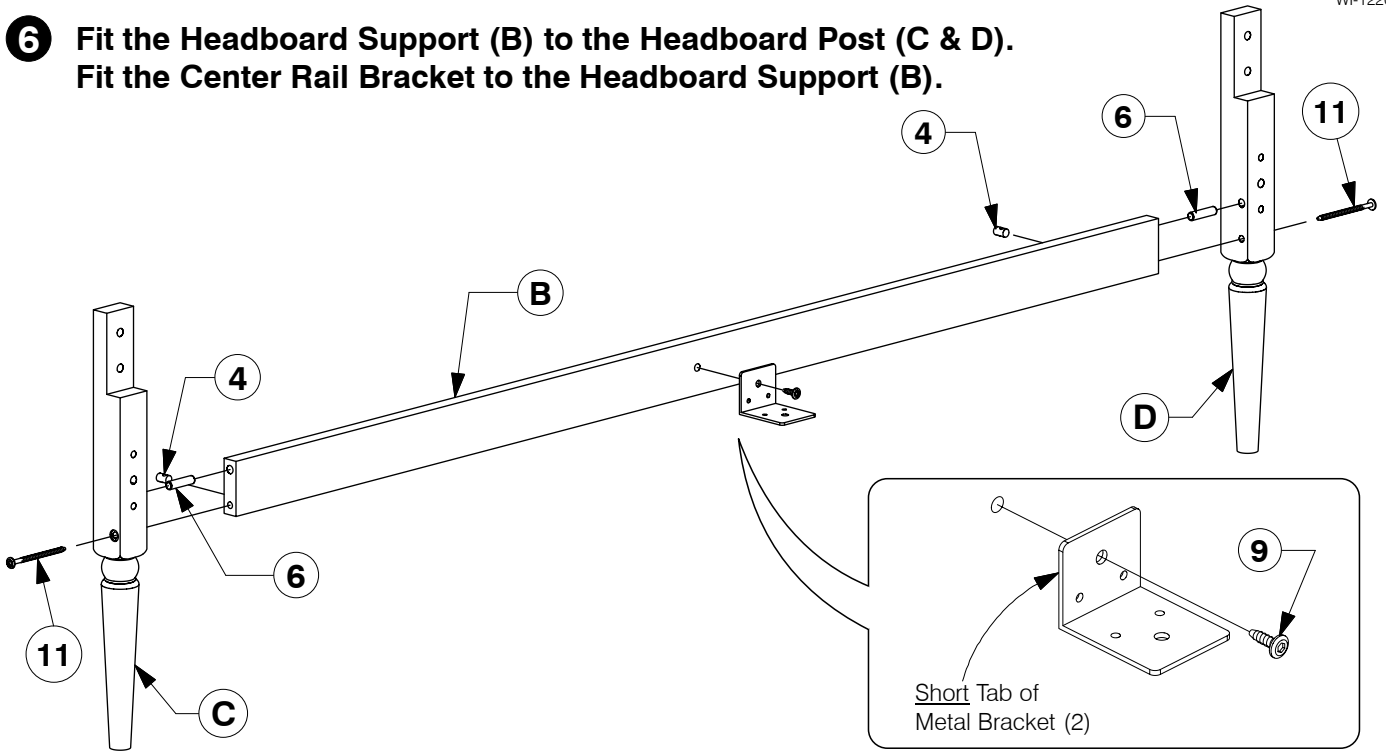

- 7** Assemble the Headboard Panel (A) to the Headboard Post (C & D).

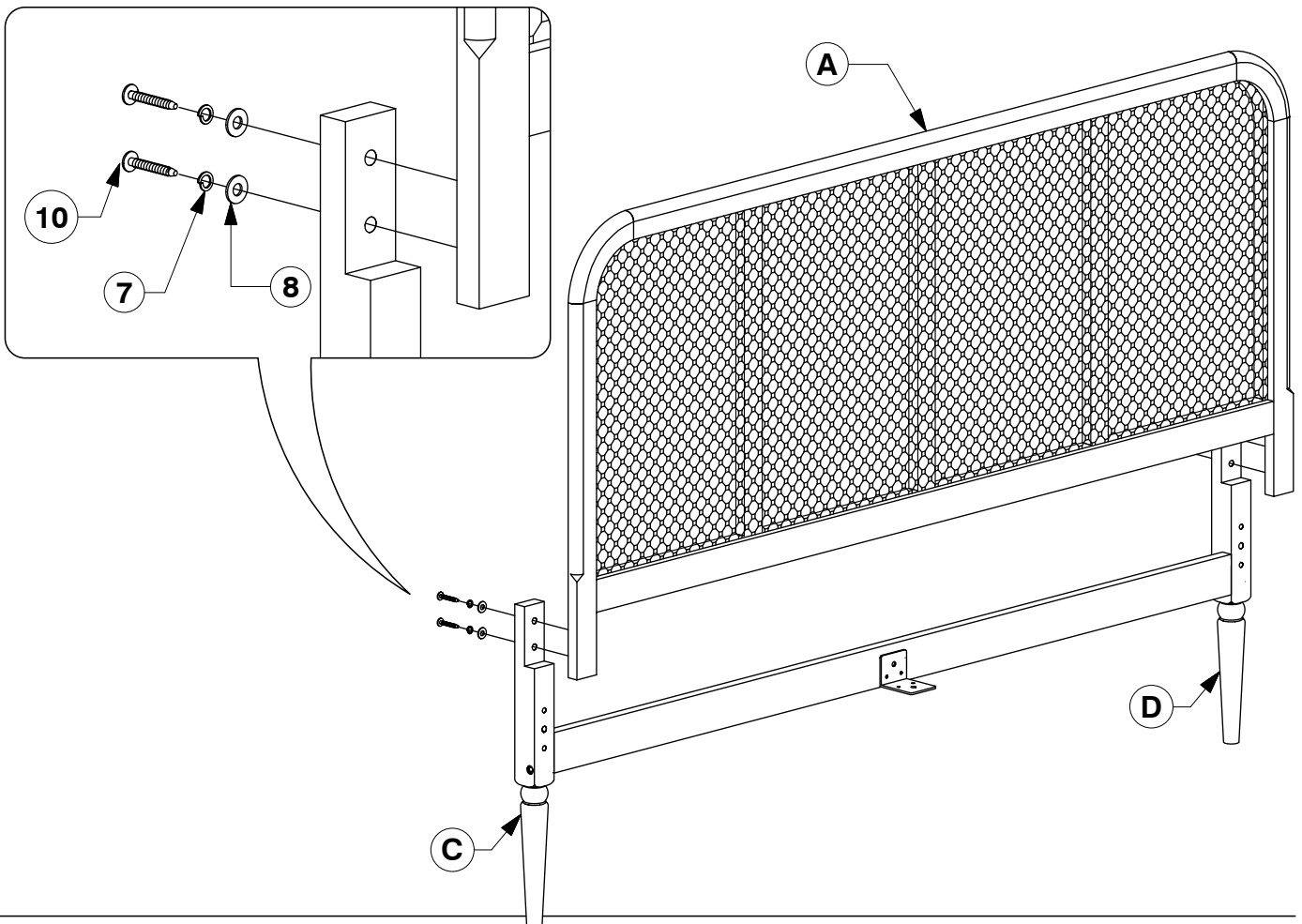

# 0056 Queen Bed

## Assembly Instructions

WI-1220

### 8 Assemble the Side Rail (F) to the Headboard & Footboard.

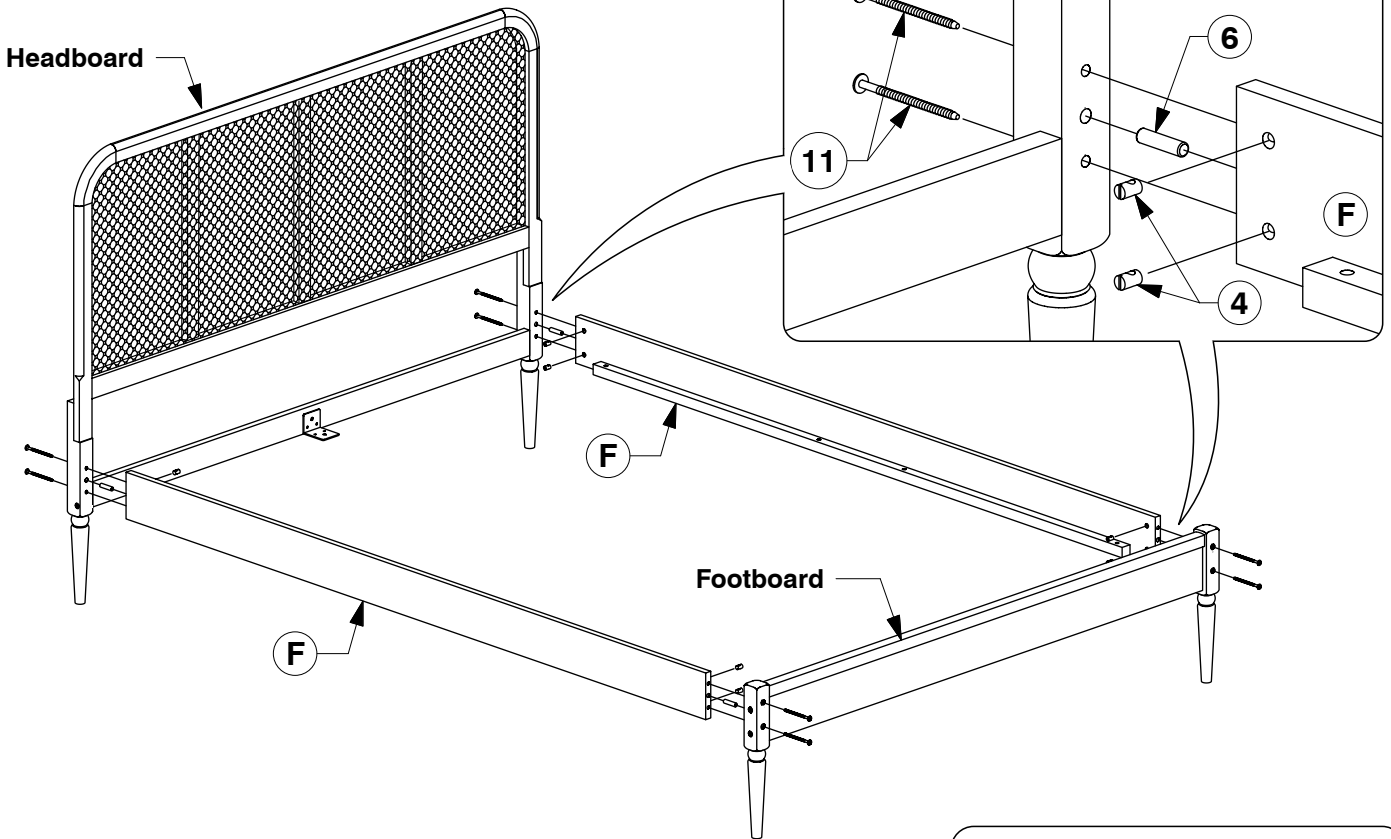

### 9 Bolt the Long Support (G) to the Center Rail Brackets (2) on the Headboard / Footboard.

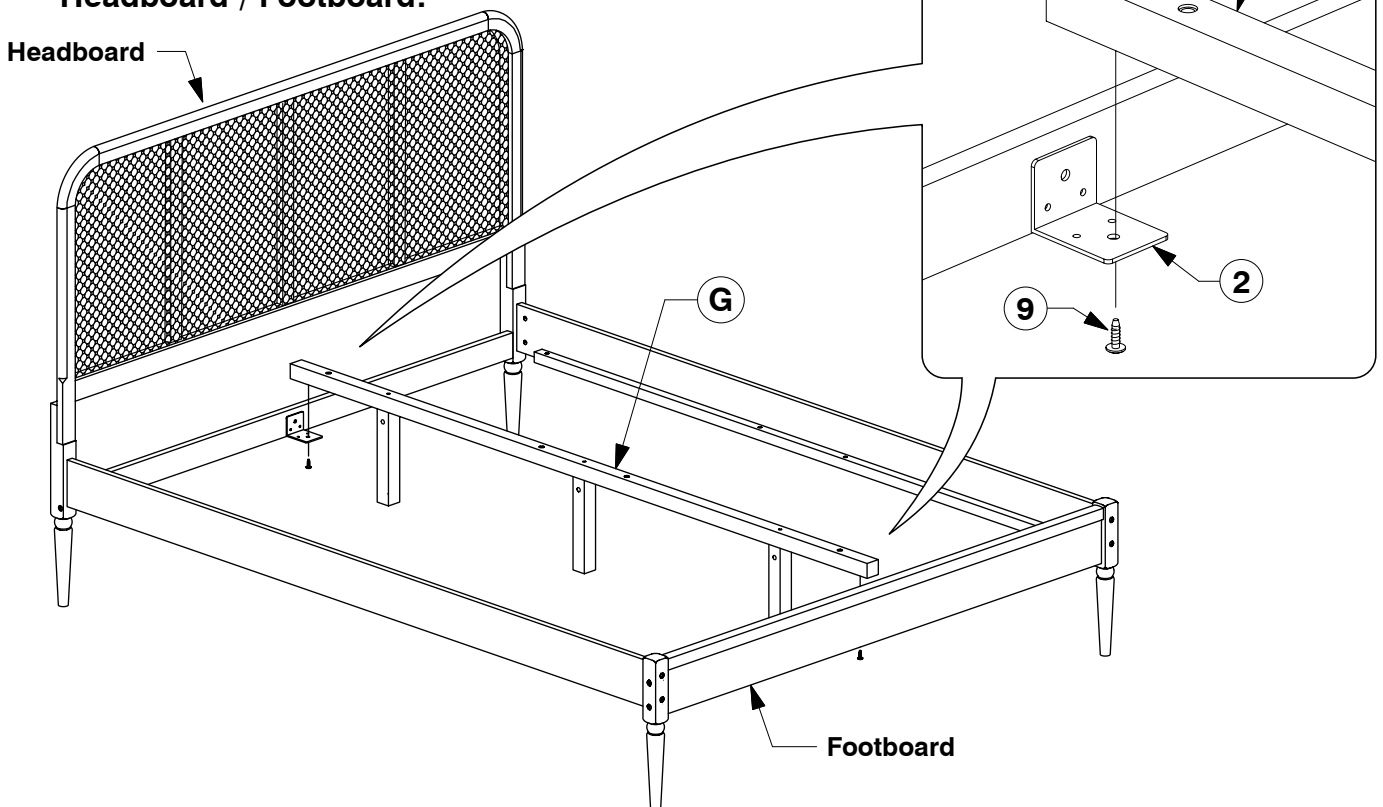

# 0056 Queen Bed

## Assembly Instructions

WI-1220

- 10** Bolt the Bed Slats (L) to the Side Rail (F).

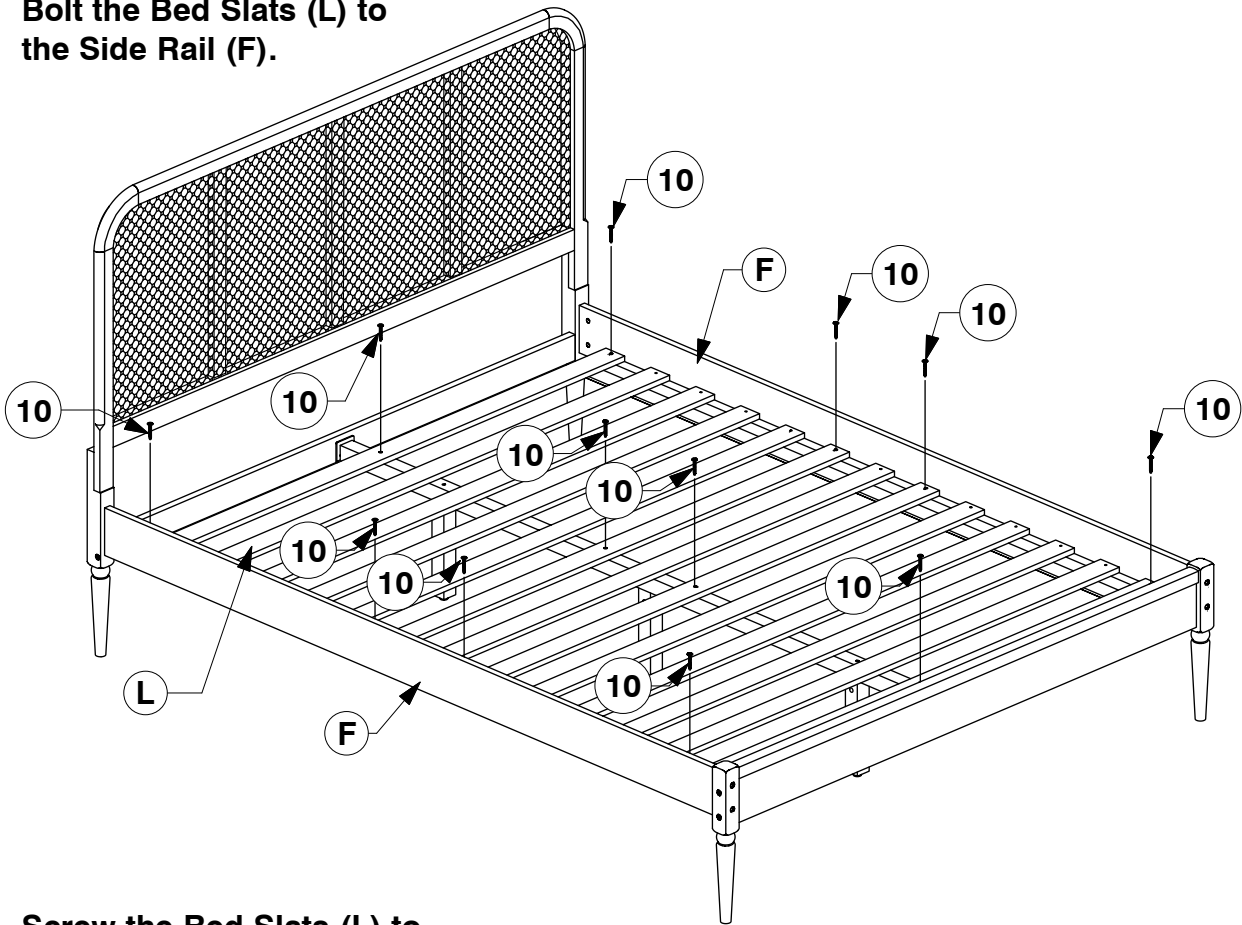

- 11** Screw the Bed Slats (L) to the Side Rail (F).

