

# 0047-5 Queen Bed

## Assembly Instructions

W11-0520

### 1 Assembled View

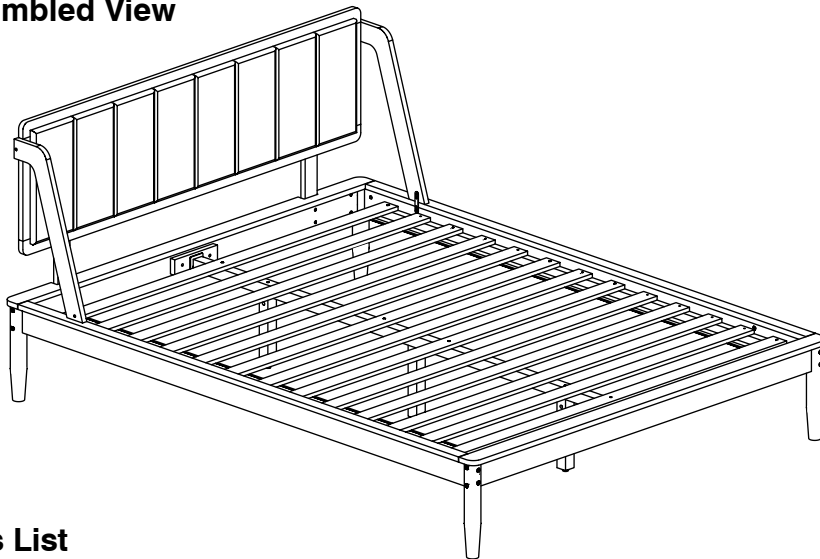

**Note:** Do not assemble using power tools. This can cause the bolts to be overtightened

### 2 Parts List

#### Parts in Box A:



**A** Headboard x 1

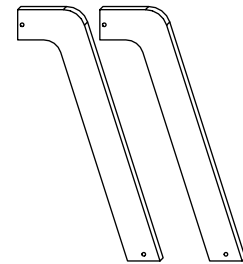

**B** Headboard Support Rail x 2

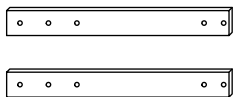

**C** Support Bar x 2



**D** Head / Footboard Support x 2

#### Parts in Box B:

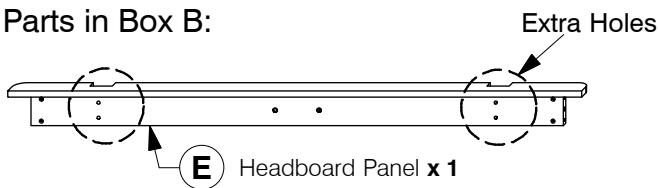

**E** Headboard Panel x 1



**F** Footboard Panel x 1

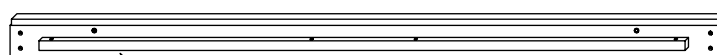

**G** Side Rail x 2

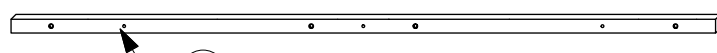

**H** Long Support x 1



**J** Post (Left Hand) x 2

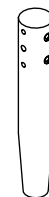

**K** Post (Right Hand) x 2



**L** Support Leg x 3

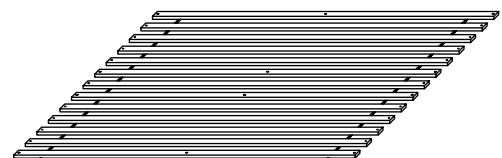

**M** Set of Bed Slats x 1

# 0047-5 Queen Bed

## Assembly Instructions

W11-0520

### 3 Hardware List



1 M4 Allen Key  
x 1

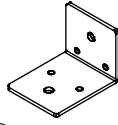

2 Center Rail  
Bracket x 2

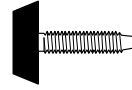

3 Adjustable  
Foot x 3

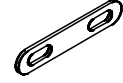

4 Bracket (2003)  
x 2



5 Wood Dowel  
(M10 x 40mm) x 8



6 Barrel  
Nut x 21

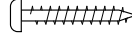

7 Wood Screw  
(M4 x 32mm) x 18



8 Spring  
Washer x 10



9 Flat Washer  
x 10



10 M6 JCN Nut  
x 2



11 M6 x 15mm JCB  
x 8

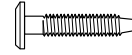

12 M6 x 30mm JCB  
x 4

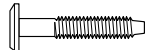

13 M6 x 35mm JCB  
x 6



14 M6 x 40mm JCB  
x 16



15 M6 x 60mm JCB  
x 2



16 M6 x 90mm JCB  
x 19

### 4 Assemble the Support Leg (L) to the Long Support (H).

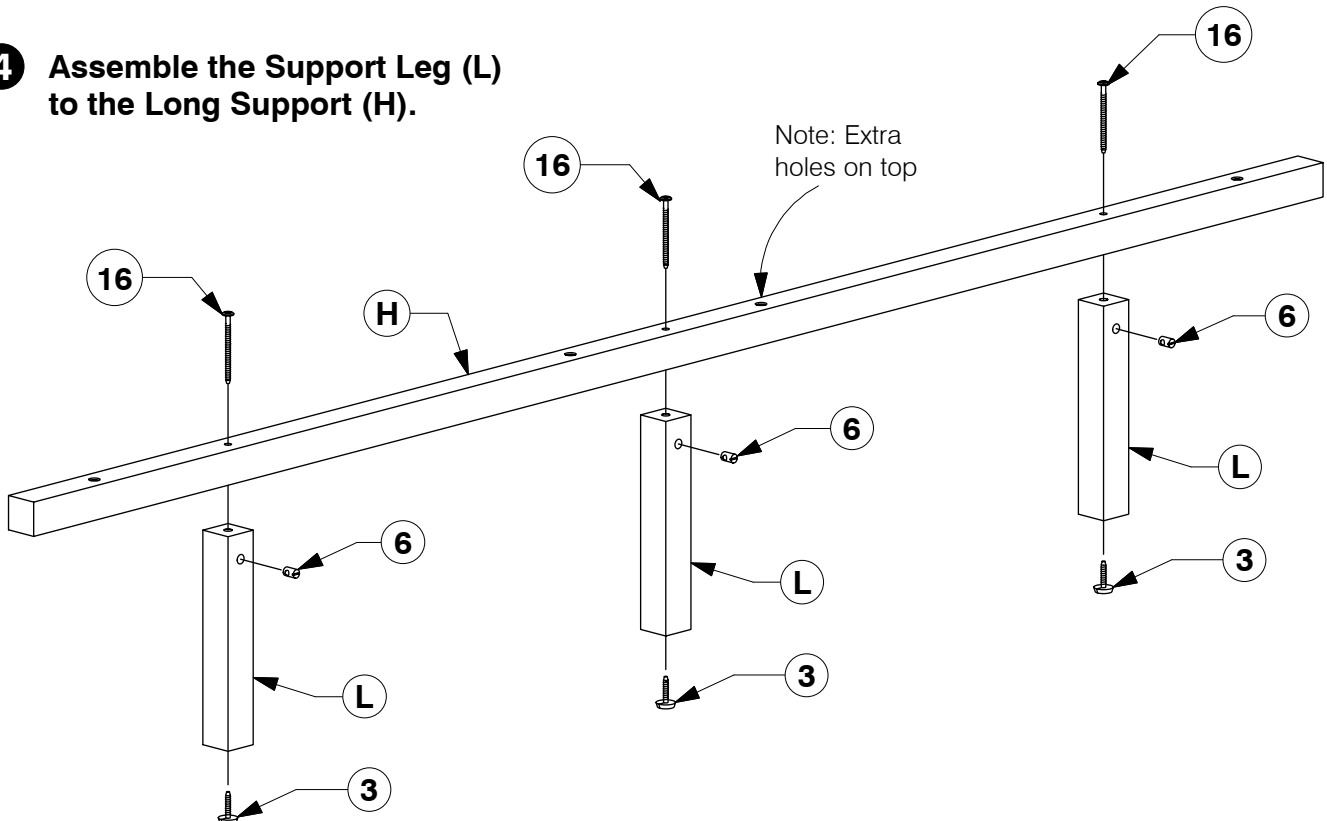

# 0047-5 Queen Bed

## Assembly Instructions

W11-0520

- 5** Fit the Center Rail Bracket to the Head / Footboard Support (D).

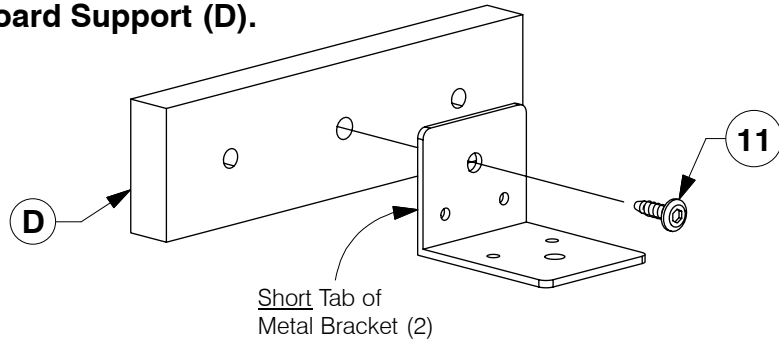

x2

- 6** Assemble the Post (J & K) and Head / Footboard Support (D) to the Headboard Panel (E).

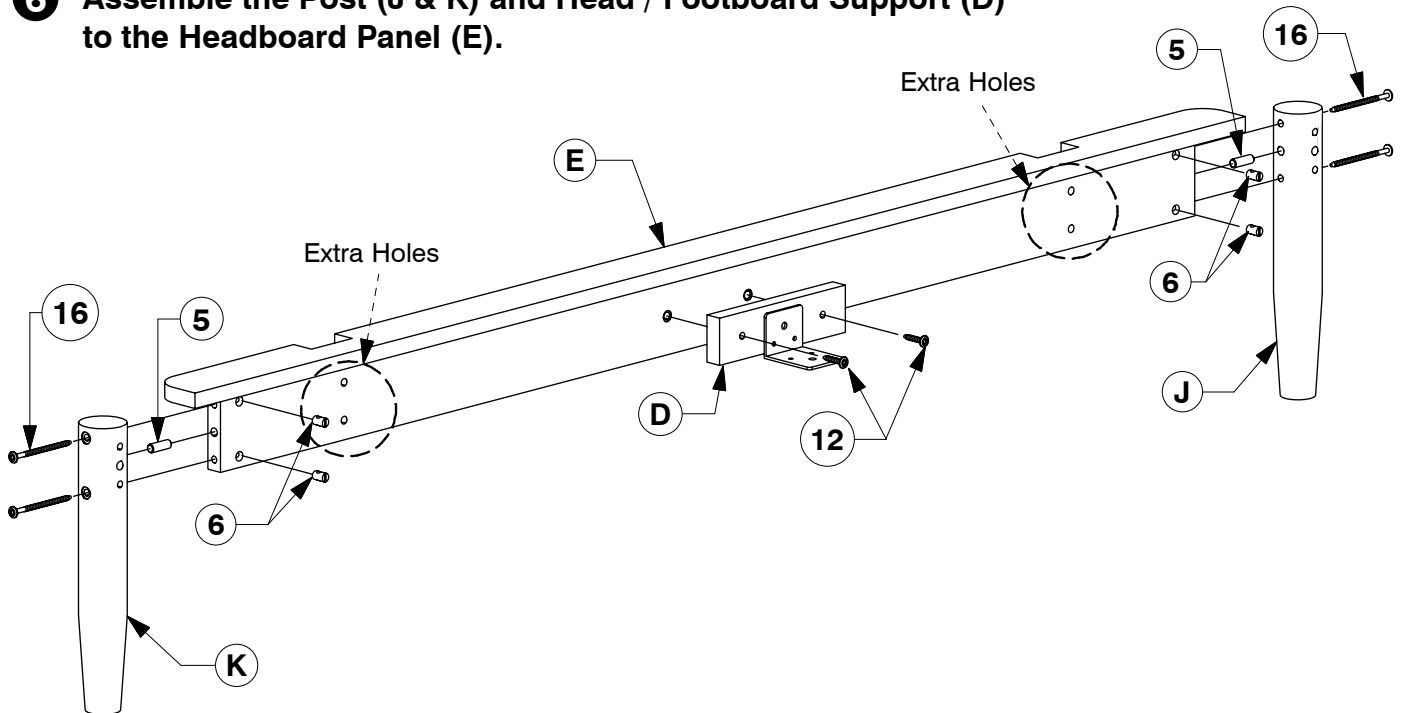

- 7** Assemble the Post (J & K) and Head / Footboard Support (D) to the Footboard Panel (F).

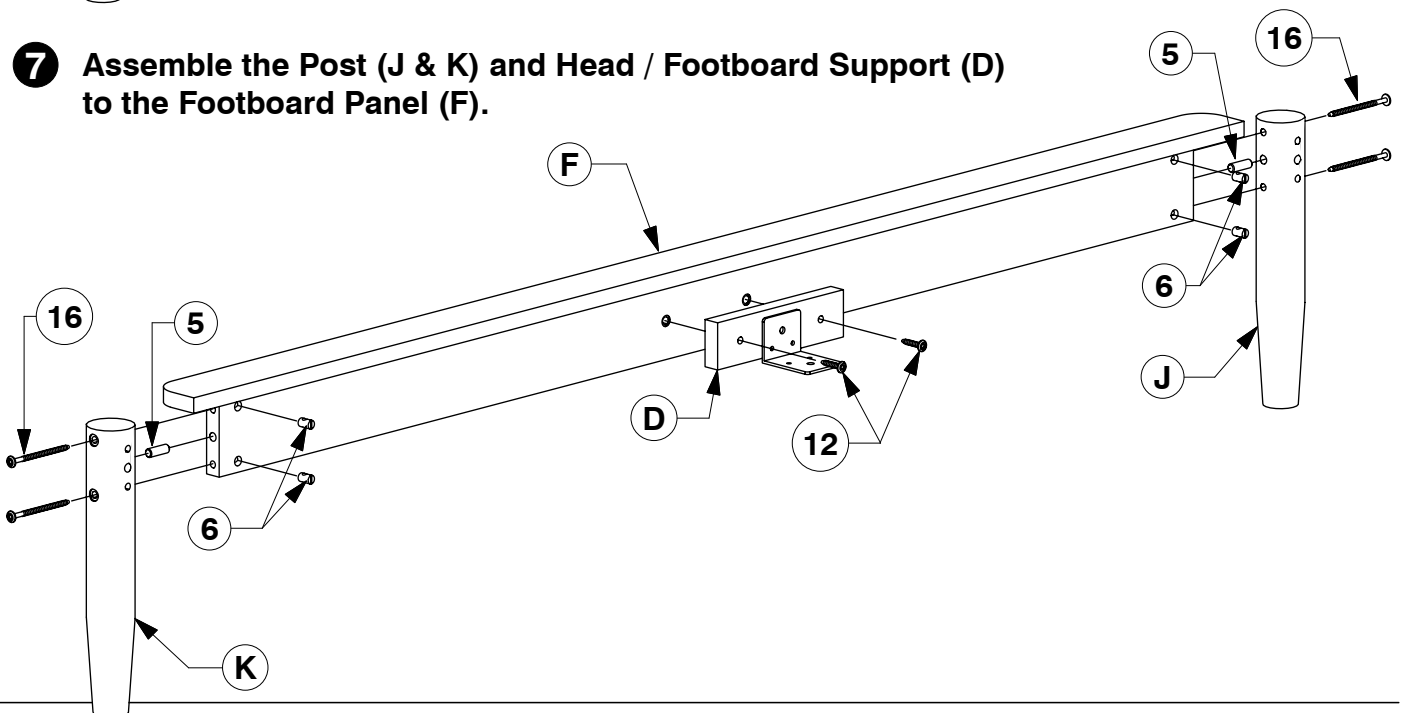

# 0047-5 Queen Bed

## Assembly Instructions

WII-0520

- 8** Assemble the Side Rail (G) to the Head & Footboard Panel (E & F).

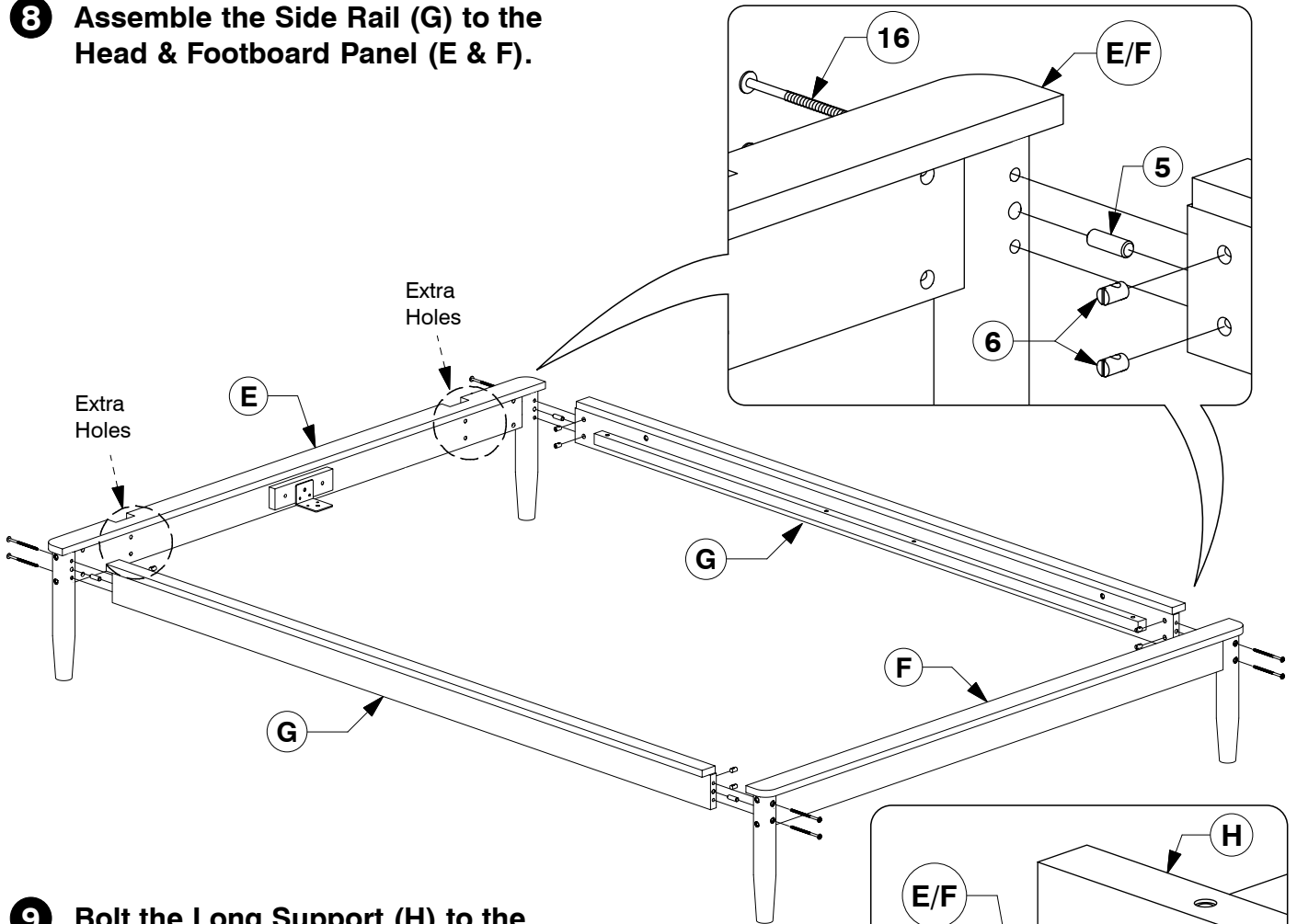

- 9** Bolt the Long Support (H) to the Center Rail Brackets on the Head & Footboard Panel (E & F).

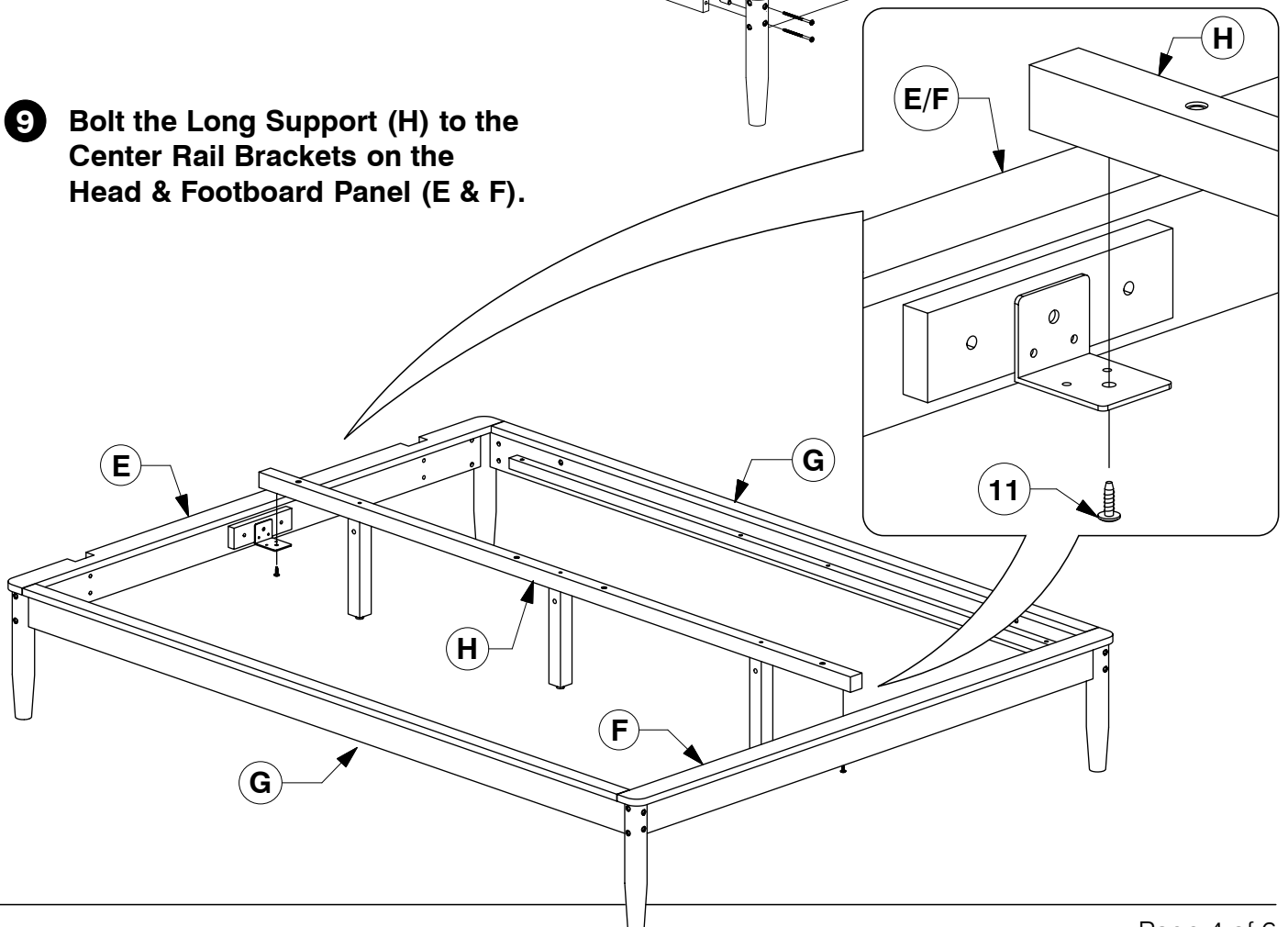

# 0047-5 Queen Bed

## Assembly Instructions

W11-0520

- 10** Bolt & screw the Bed Slats (M) to the Side Rail (G).

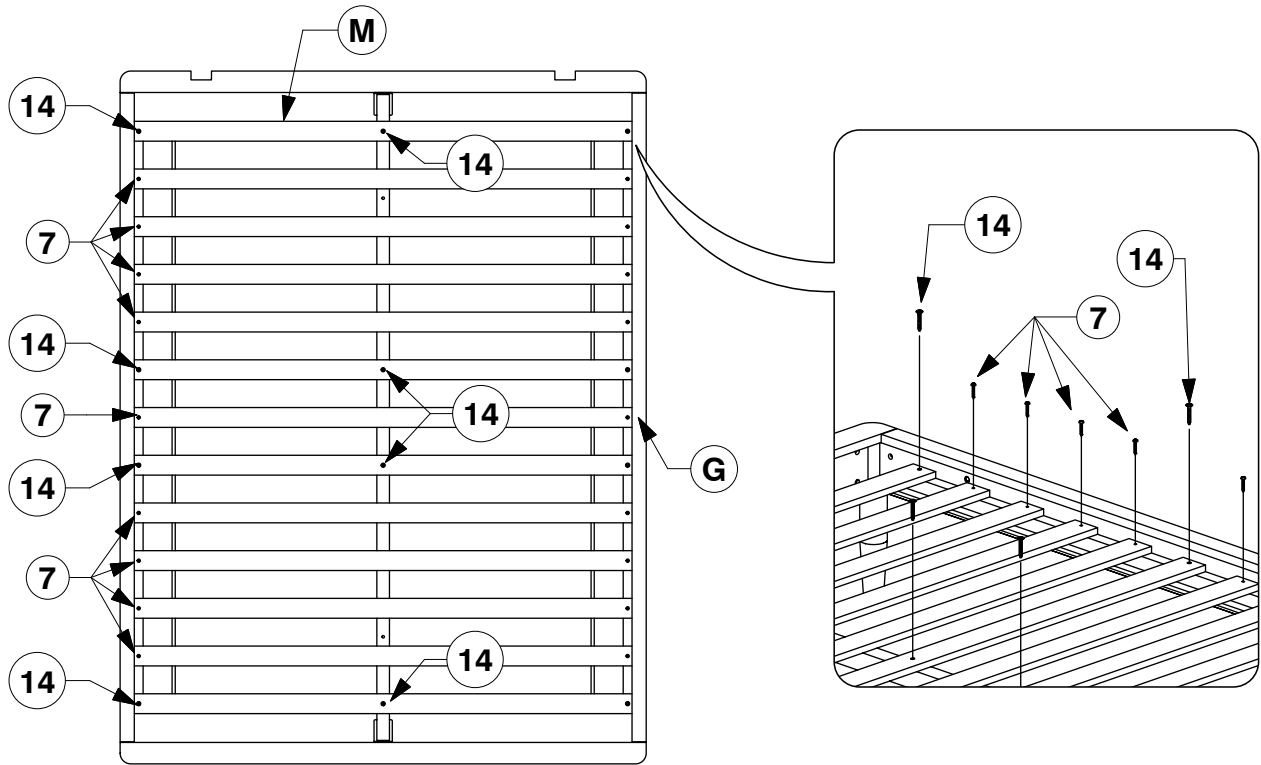

- 11** Assemble the Support Bars (C) to the Headboard Panel (E).

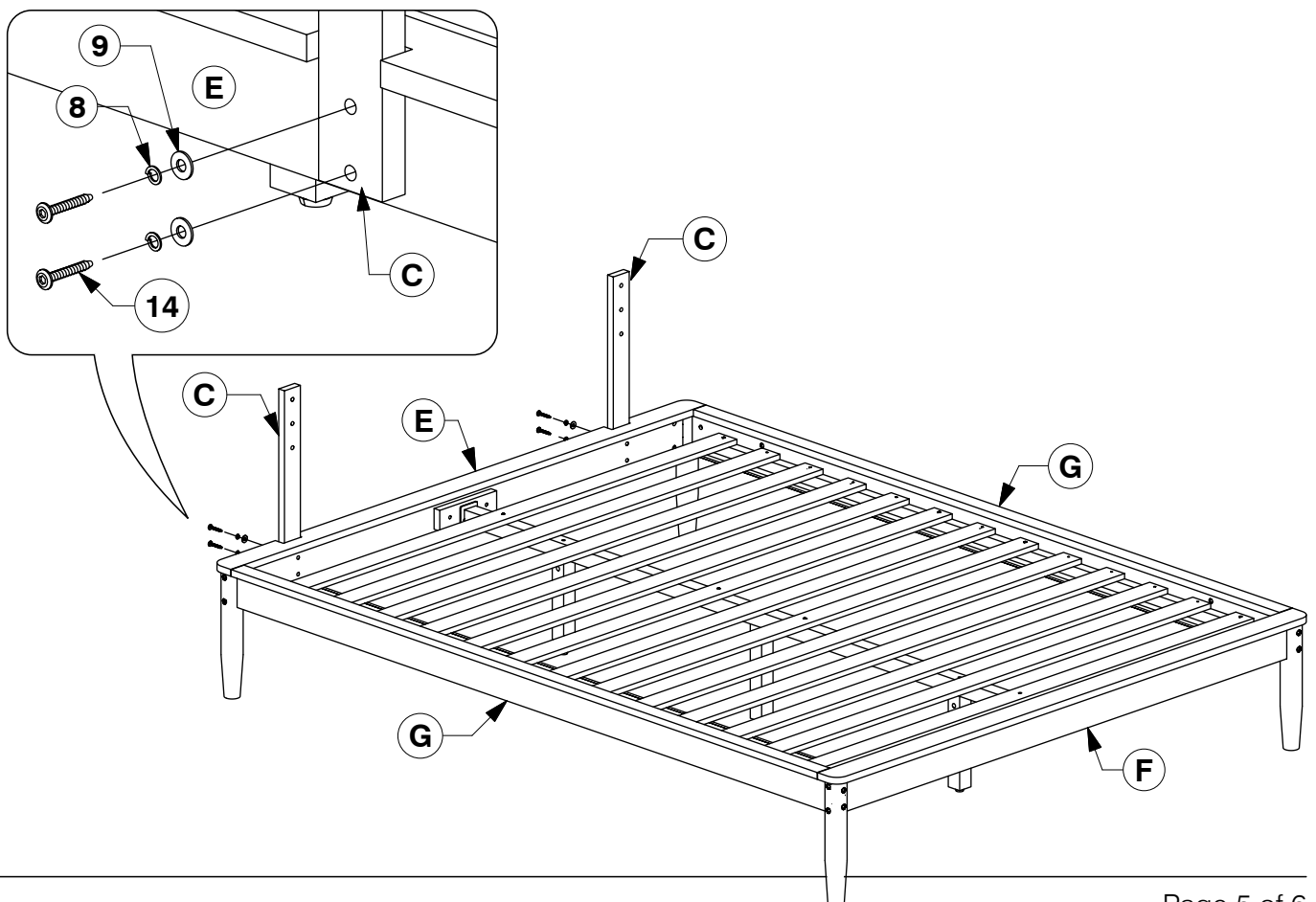

# 0047-5 Queen Bed

## Assembly Instructions

W11-0520

- 12** Assemble the Headboard (A) to the Support Bars (C).

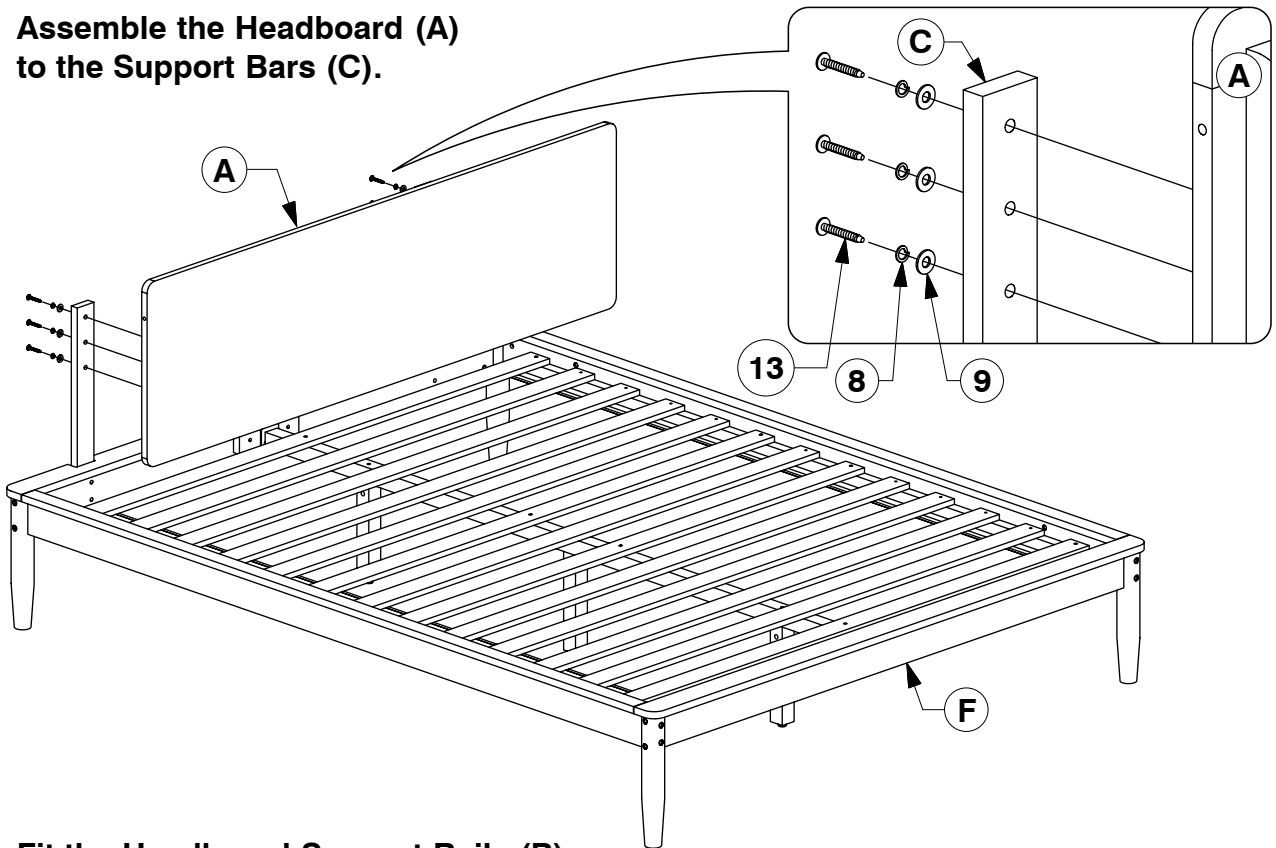

- 13** Fit the Headboard Support Rails (B) to the Headboard Panel (A) & Side Rail (G).

