

ASSEMBLY INSTRUCTION





MODEL : 339C

Read this instruction carefully. Remove all wrapping material, staples and straps from the carton. See hardware and furniture part list
For guidance. Be sure you have all wooden furniture parts on a clean and flat soft surface, such as a carpet or rug, to prevent from being scratched. Follow the figure to start assembling.

CAUTION :

1. Do not FULLY - TIGHTEN the nut or screw until all is ready to assemble.
2. Do not OVER - TIGHTEN the nut or screw to avoid causing damages to the thread.
3. Keep all hardware part out reach of children.

NO	PART LIST	QTY
A	BACK REST	1 PC
B	FRONT LEG	1 PC
C	SIDE RAIL	2 PCS
D	WOODEN SEAT WITH SCOOP	1 PC

NO	DESCRIPTION	QTY
1	JCBC SCREW M6 X 50MM 	6 PCS
2	WOOD DOWEL Ø8 x 30MM 	4 PCS
3	CSK SCREW M4 x 30MM 	3 PCS
4	SPRNG WASHER M6 	6 PCS
5	M4 ALLEN KEY 	1 PC

STEP 1

Attached C to B according to the hole and tighten it using hardware number 1,2,4, and 5.

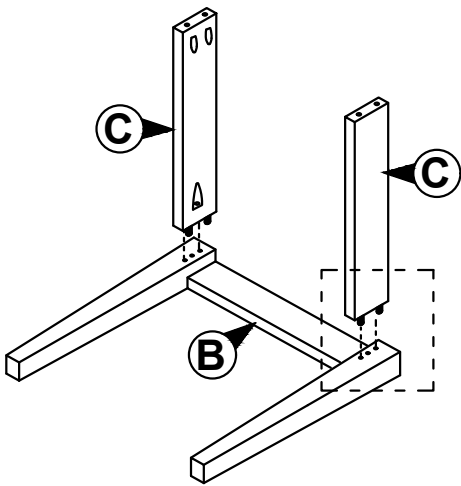
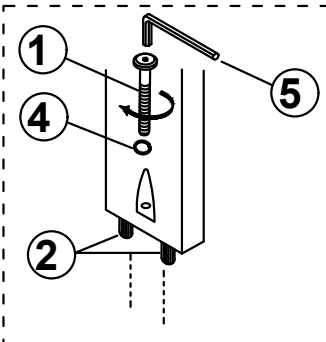

STEP 2

Align the whole part from STEP 1 to A. Tighten the part of C and A using hardware number 1,4 and 5.

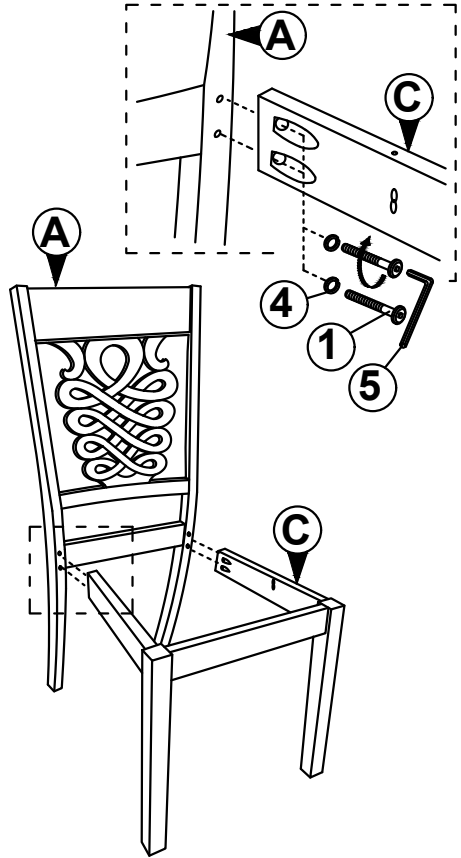

STEP 3

Stick D to the whole assemble part and fully-tighten it with hardware number 3.

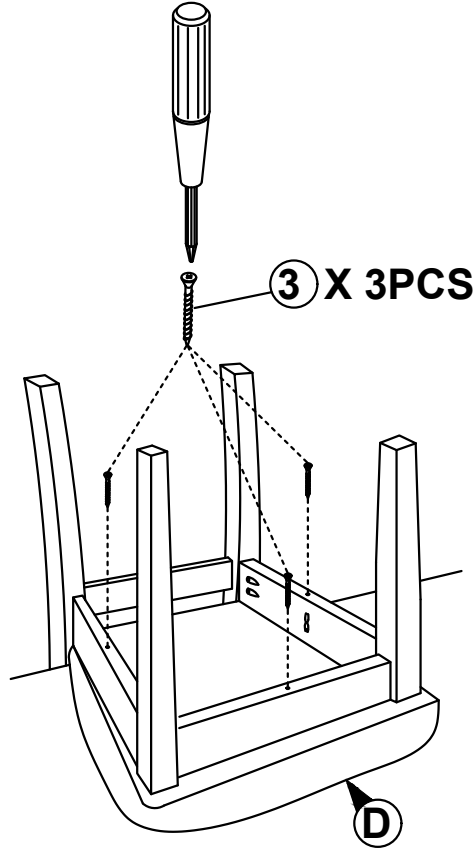

STEP 4

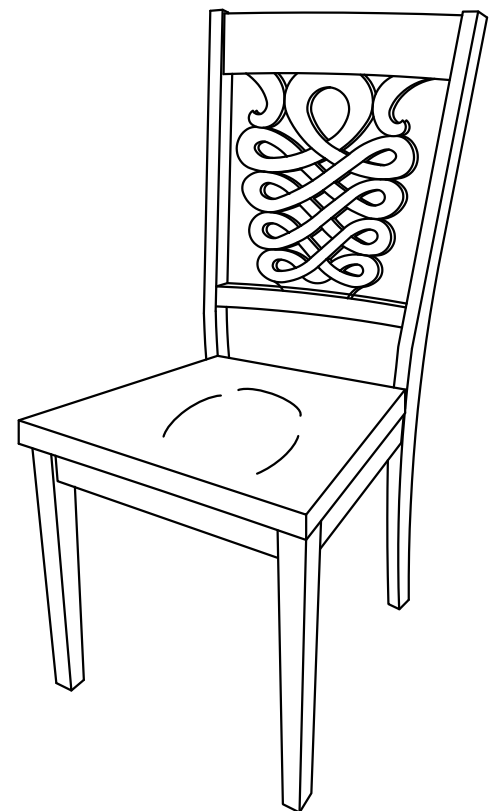

COMPELETE ASSEMBLE

ASSEMBLY INSTRUCTIONS

MODEL : 7008T

Read this instruction carefully, remove all wrapping material, staples and straps from the carton. See hardware and furniture part list. For guidance. Be sure you have all wooden furniture parts on a clean and soft surface to prevent from being scratched. Follow the figure to start assembling.

Caution:

1. Do not FULLY -TIGHTEN the nut or bolt until all nut or nut bolt is ready to assembled.
2. Do not OVER- TIGHTEN the nut or nut bolt to avoid causing damages to the thread.
3. Keep all hardware part out of reach of children.

PART LIST

No.	DESCRIPTION	QTY
A	TABLE TOP	1 PC
B	TABLE LEG	4 PCS

HARDWARE LIST

No.	DESCRIPTION	QTY
1	FLAT WASHER 6/19"	8 PCS
2	SPRING WASHER 6/13"	8 PCS
3	JCBC SCREW M6 X 70MM	8 PCS
4	M4 ALLEN KEY	1 PC

STEP 1

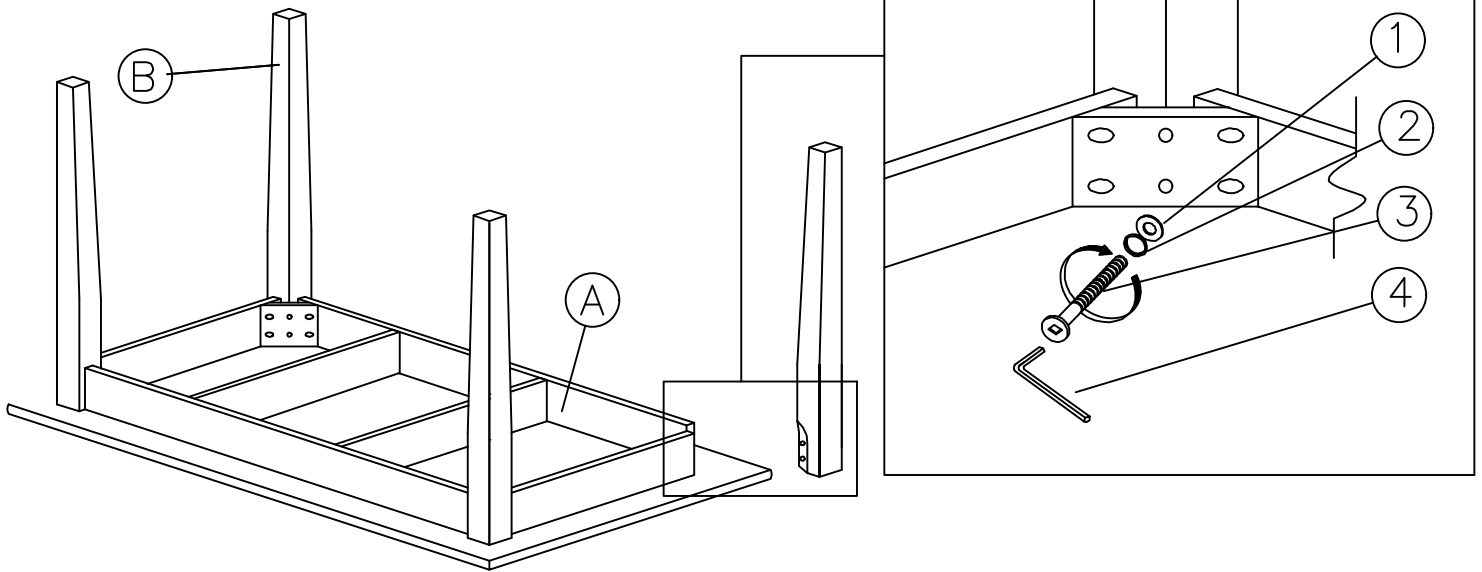

STEP 2

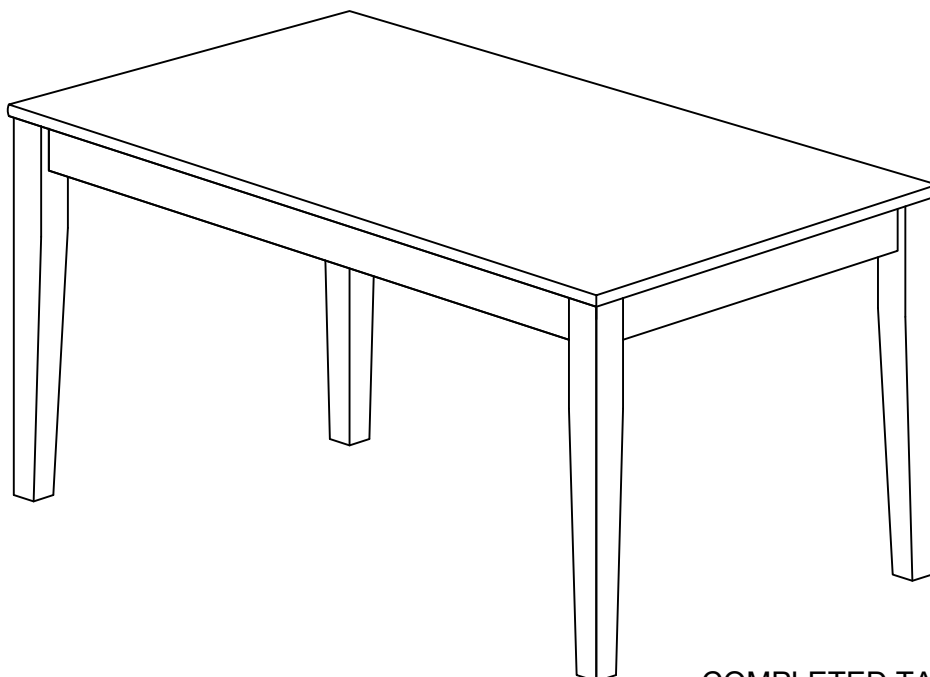

COMPLETED TABLE ASSEMBLY