

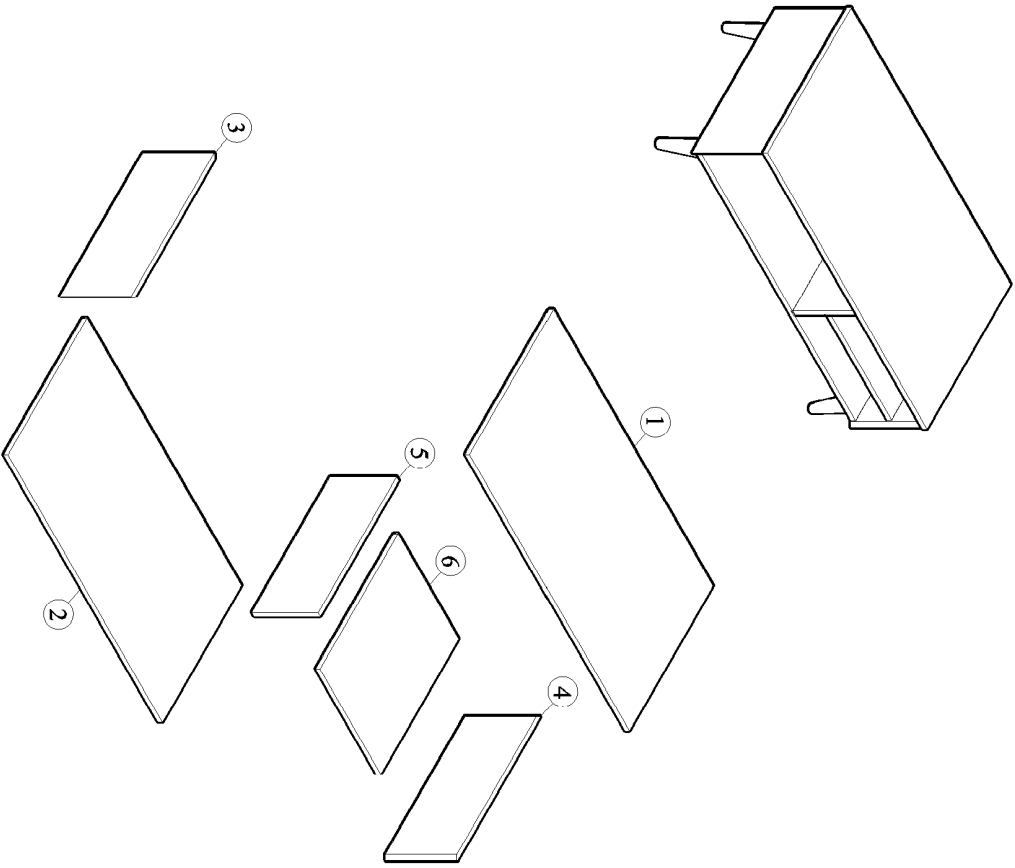













MODEL : LV10 CFT 1014WI-CLB

POSITION & PARTS NUMBER

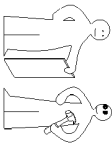
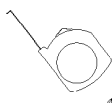
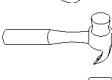

	ACCESSORIES	QUANTITY
A	 WOOD DOWEL M8 x 30MM	16 PCS
B	 MINIFIX M5 x 24MM	10 PCS
C	 MINIFIX CASING	10 PCS
D	 IRON SHELF SUPPORT	4 PCS
E	 SCREW M6 x 50MM	2 PCS
F	 ROUND TAPER LEG SCREW M3.5 x 16MM	5 PCS 20 PCS
G	 ALLEN KEY	1 PC

CHEMICAL	HANDLE WITH CARE	KEEP DRY	HARD STORAGE
			
X	✓	✓	X

			
---	---	---	---

START ASSEMBLY

STEP 1

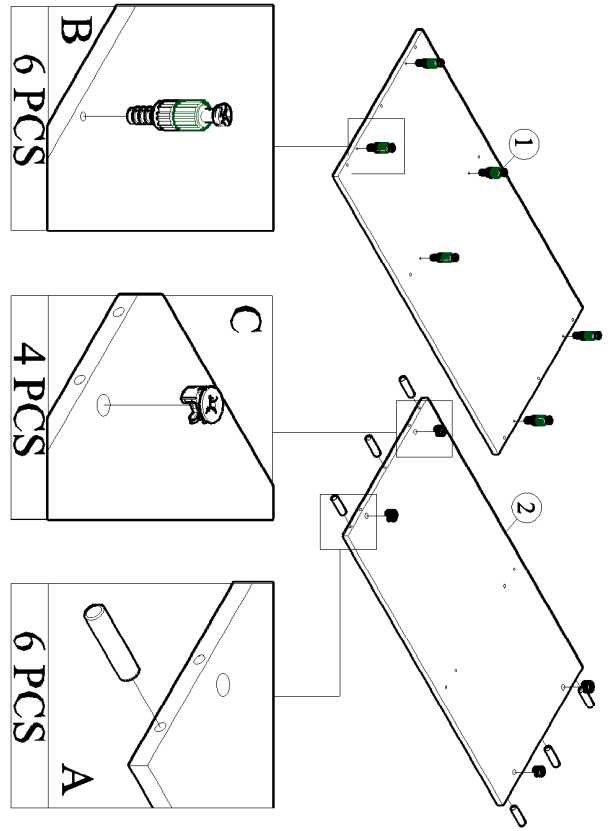

STEP 2

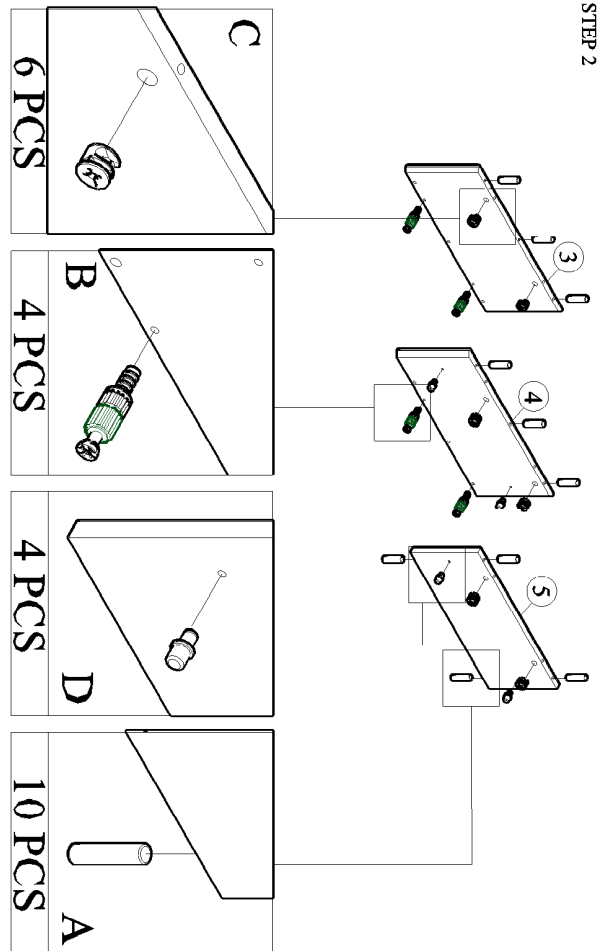

STEP 3

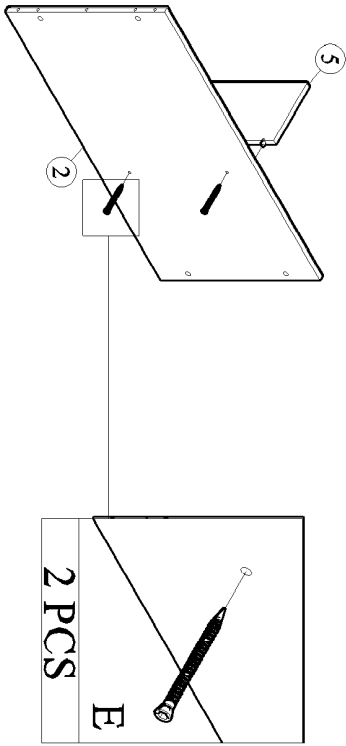

STEP 4

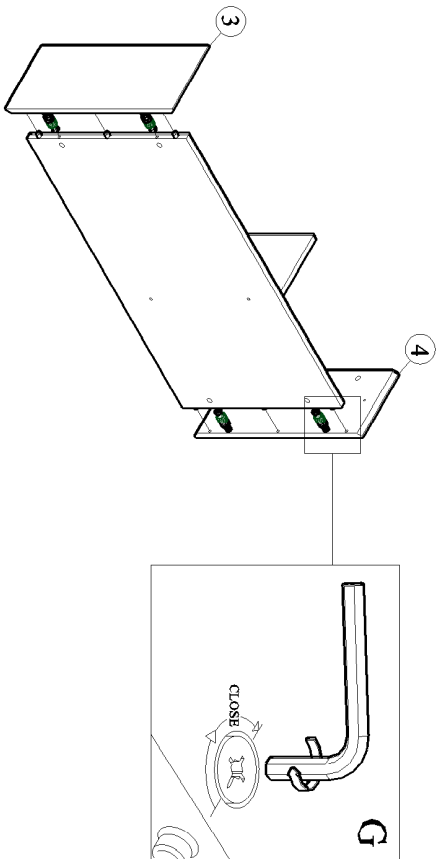

STEP 5

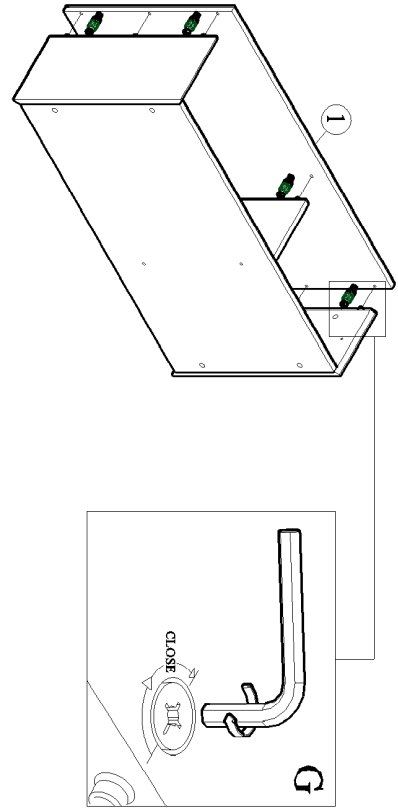

STEP 6

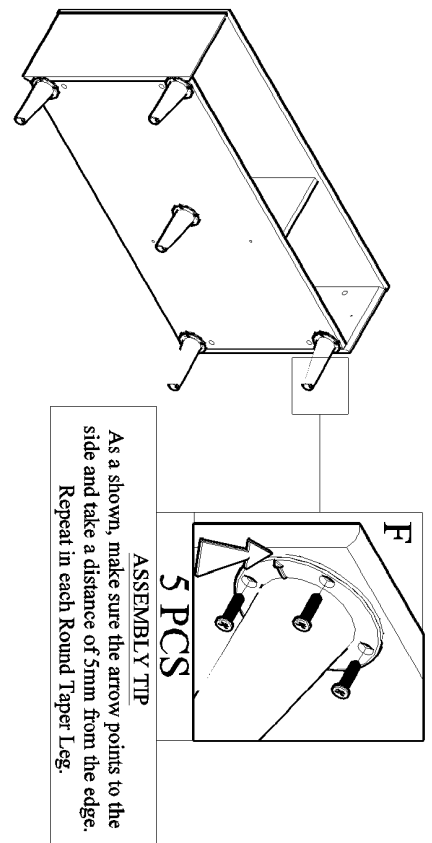

STEP 7

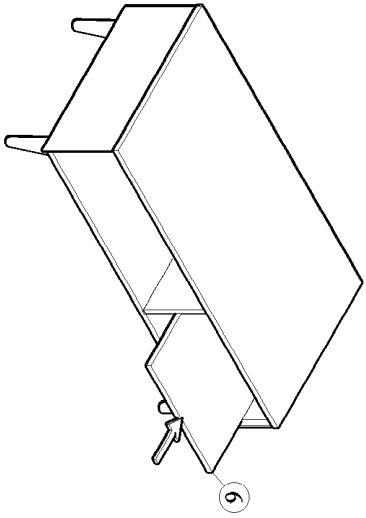

COMPLETED

