

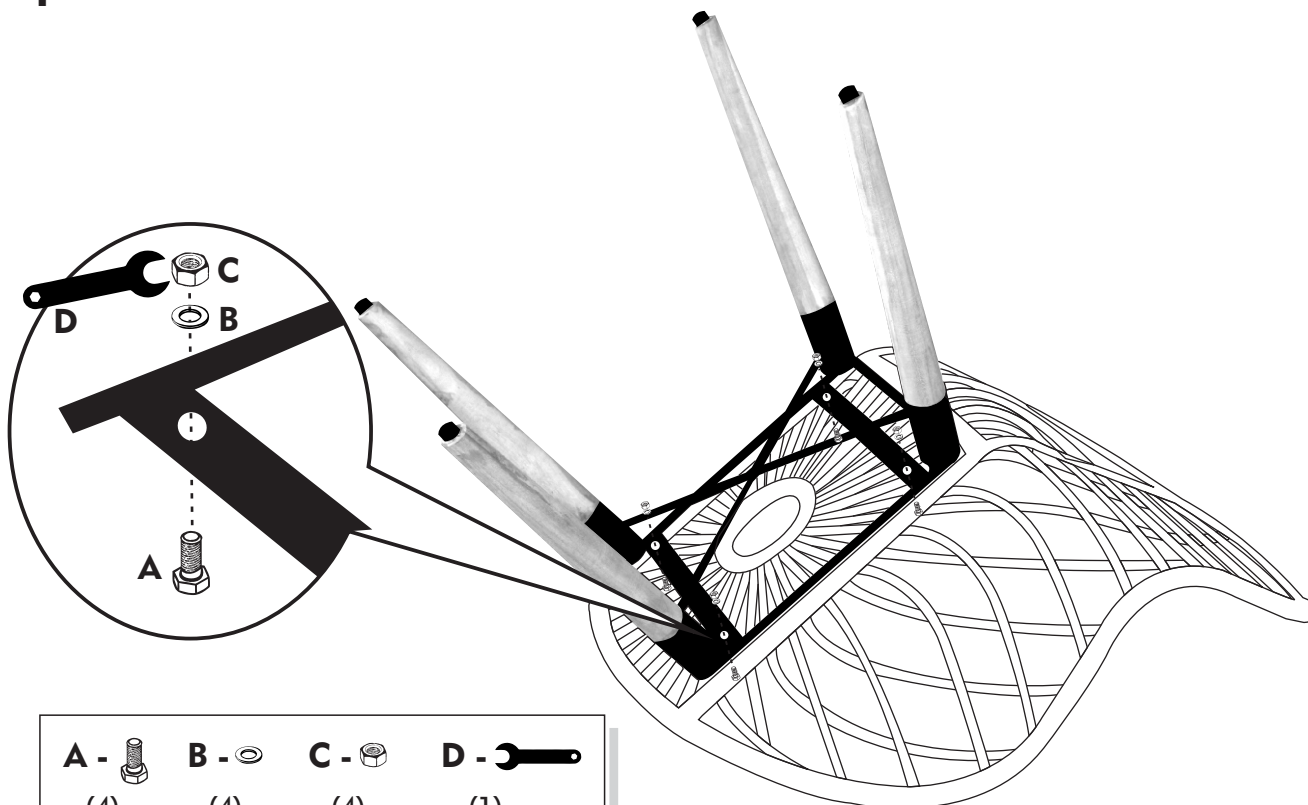



ASSEMBLING INSTRUCTIONS

1



- | | | | |
|--|--|--|--|
| A -  | B -  | C -  | D -  |
| (4) | (4) | (4) | (1) |

2



ASSEMBLY INSTRUCTIONS

MODEL : SHERWIN TABLE

Read this instruction carefully. Remove all wrapping material, staples and straps from the carton. See hardware and furniture part list for guidance.

Be sure you have all parts before you start assembling. Place all wooden furniture parts on a clean and flat soft surface, such as a carpet or rug, to prevent from being scratched.

CAUTION:

1. Do Not FULLY - TIGHTEN the nut or screw until all is ready to assemble.
2. Do Not OVER - TIGHTEN the nut or screw to avoid causing damages to the tread.
3. Keep all hardware part out reach of children.

Part List

No.	Description	Qty
A	Table Top	1 pc
B	Leg	4 pcs

Hardware List

No.	Description	Qty
1	JCBC M6 x 80mm	8 pcs
2	Spring Washer M6	8 pcs
3	Flat Washer M6 x 19mm	8 pcs
4	Allen Key M4 x 110mm	1 pc

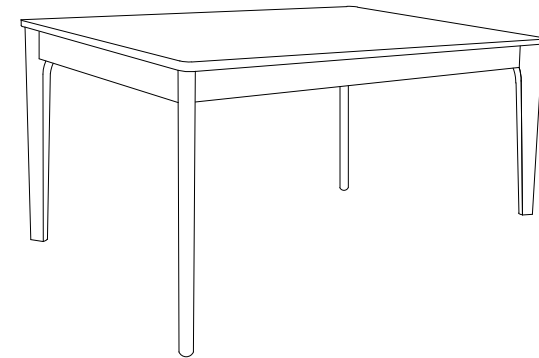
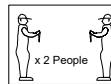

Step 1

