

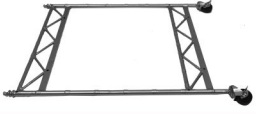





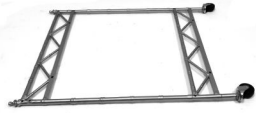

#12527 ASSEMBLY INSTRUCTION

A		1PC	E		2PCS
B		1PC	F		8PCS
C		1PC	G		10PCS
D		3PCS	H		1PC

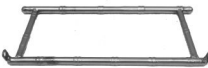
STEP 1

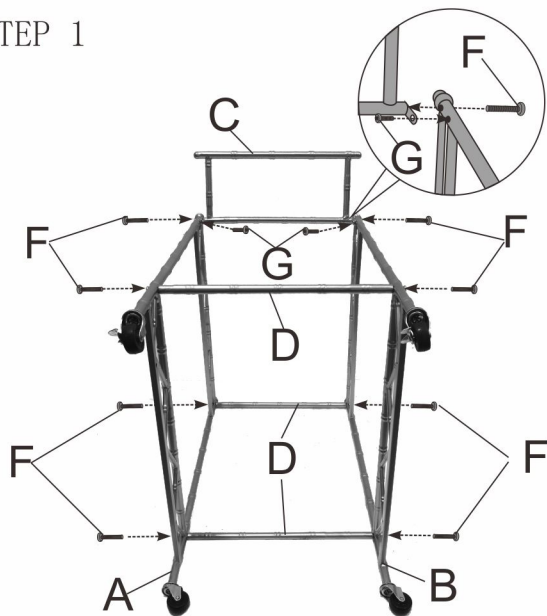

Place the metal legs(A,B) to a soft surface, and fasten the handle(C) and metal side parts(D), by using nuts (F,G) with wrench.

STEP 2

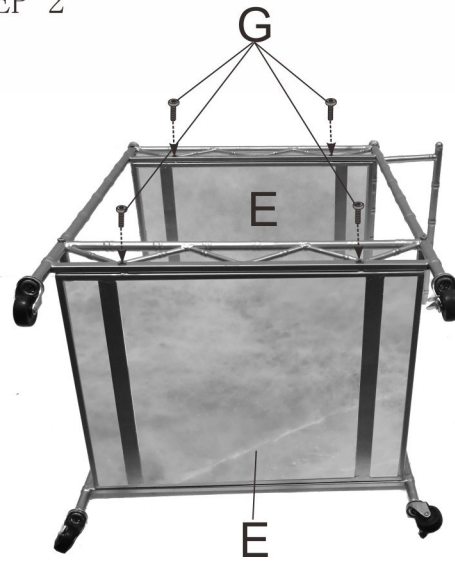

Attach the top and bottom shelves(E) to the assembled parts.

STEP 3



And tighten the shelves by using nuts(G), and using wrench(H).

FINISH



Turn over the whole cart to an upright position.