

Assembly Instruction

WI5307 / WI9390 / WI11927

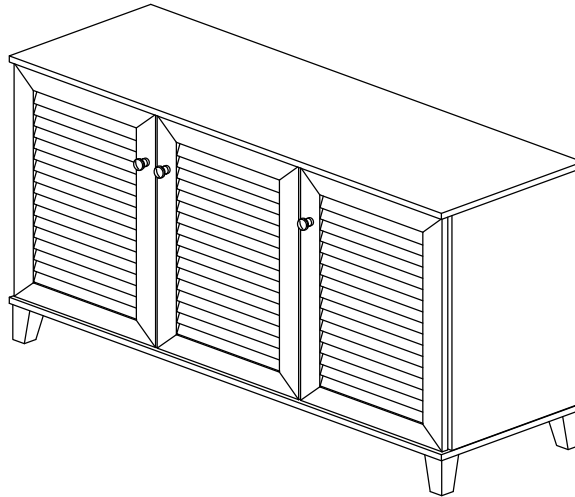

Part List

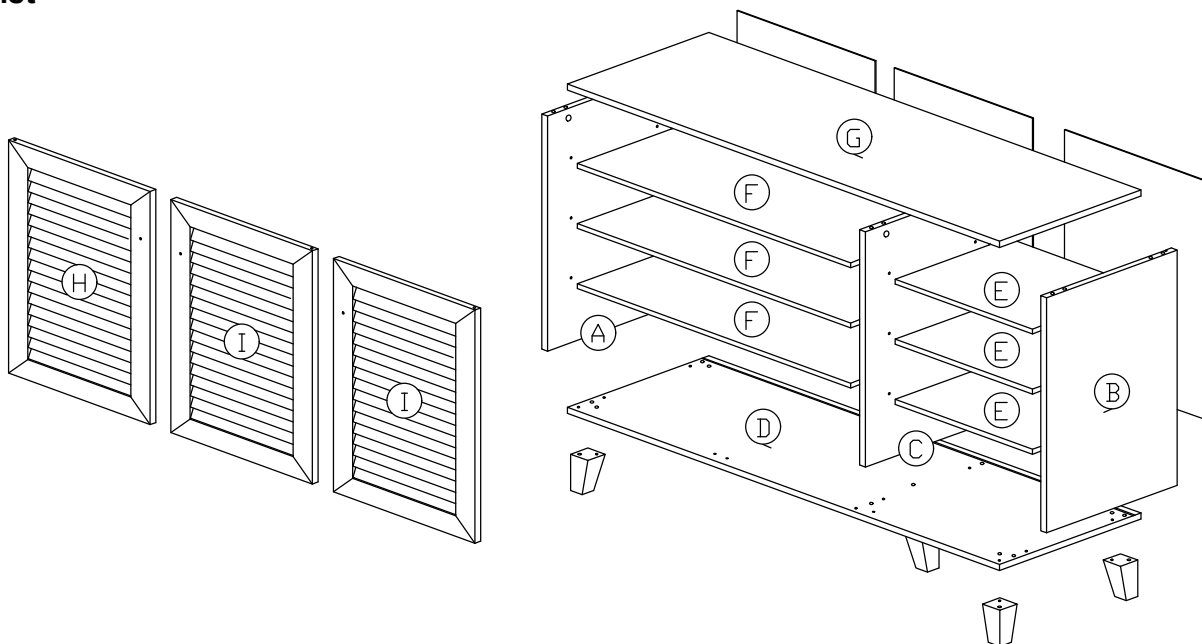

Hardware List

No.	SHAPE	DESCRIPTION	Qty.
1		8x25mm Wood Dowel	17Pcs
2		15MM Titus Mini Fix	6Sets
3		M3x16mm Screw	8Pcs
4		M4x38mm Screw	6Pcs
5		M7x40mm Screw	5Pcs
6		Shelf Support	27Pcs
7		M6x22 Steel Bracket	6Pcs
8		Brown Magnet 2 Pin Flat Head Tapping Screw M6x10mm ZB	3Sets
9		Handle (9988) M4x25mm (Handle Screw)	3Sets

10		Wooden Leg	5Pcs
11		L Key	1Pc
12		Z Bracket	4Pcs

Packing Tipping Restraint

13		M3.5x15mm Screw	2Pcs
14		Wall Plug	2Pcs
15		M4x30mm Screw	2Pcs
16		Safety Strap	2Pcs
17		Flat Washer 6x19x2mm	4Pcs

Assembly Instruction

Step 1

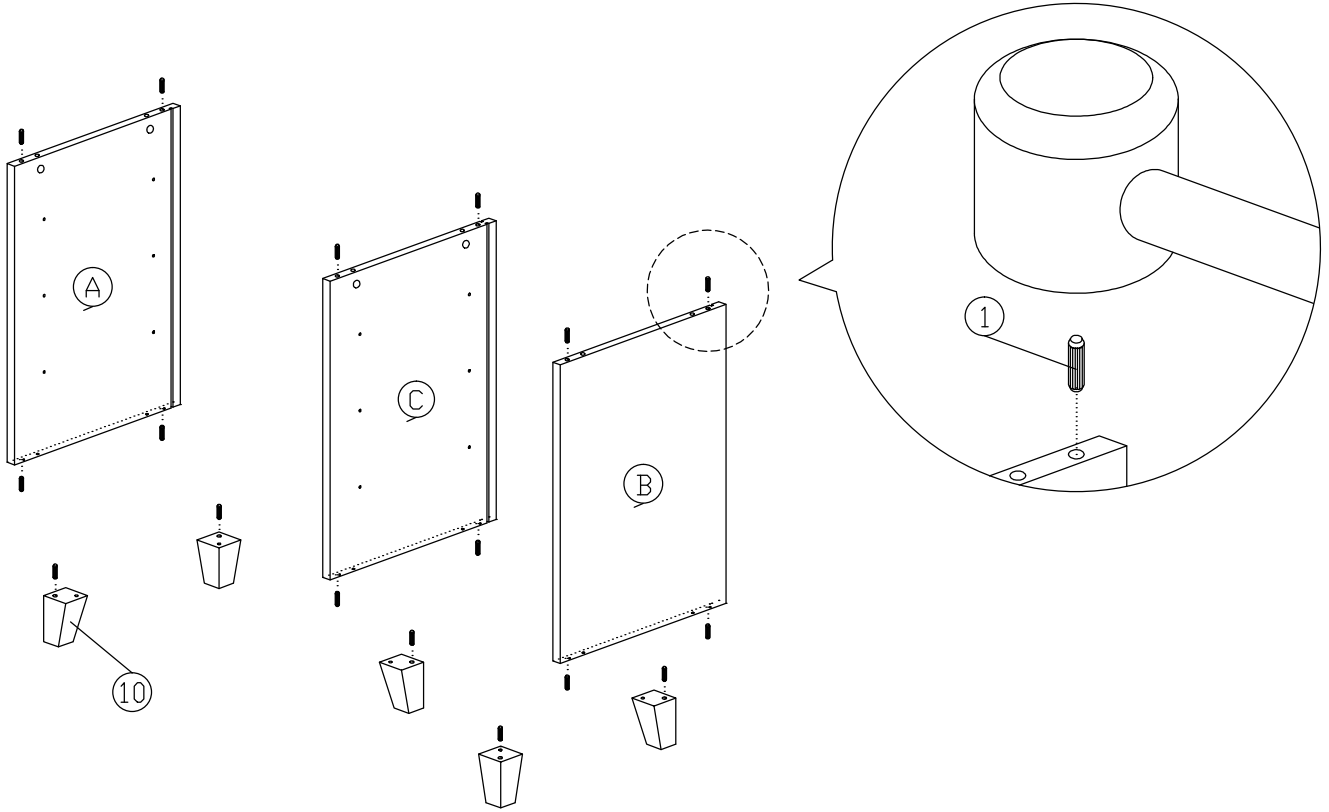

Step 2

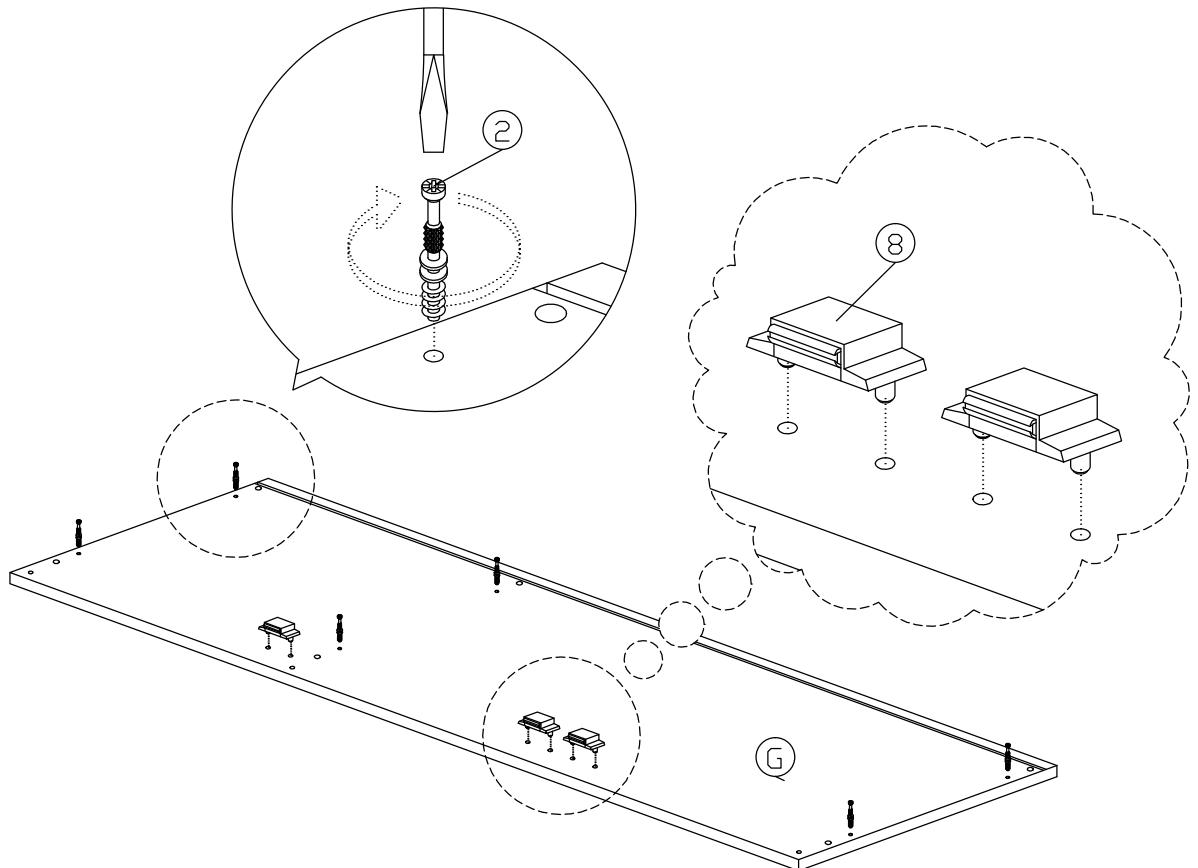

Assembly Instruction

Step 3

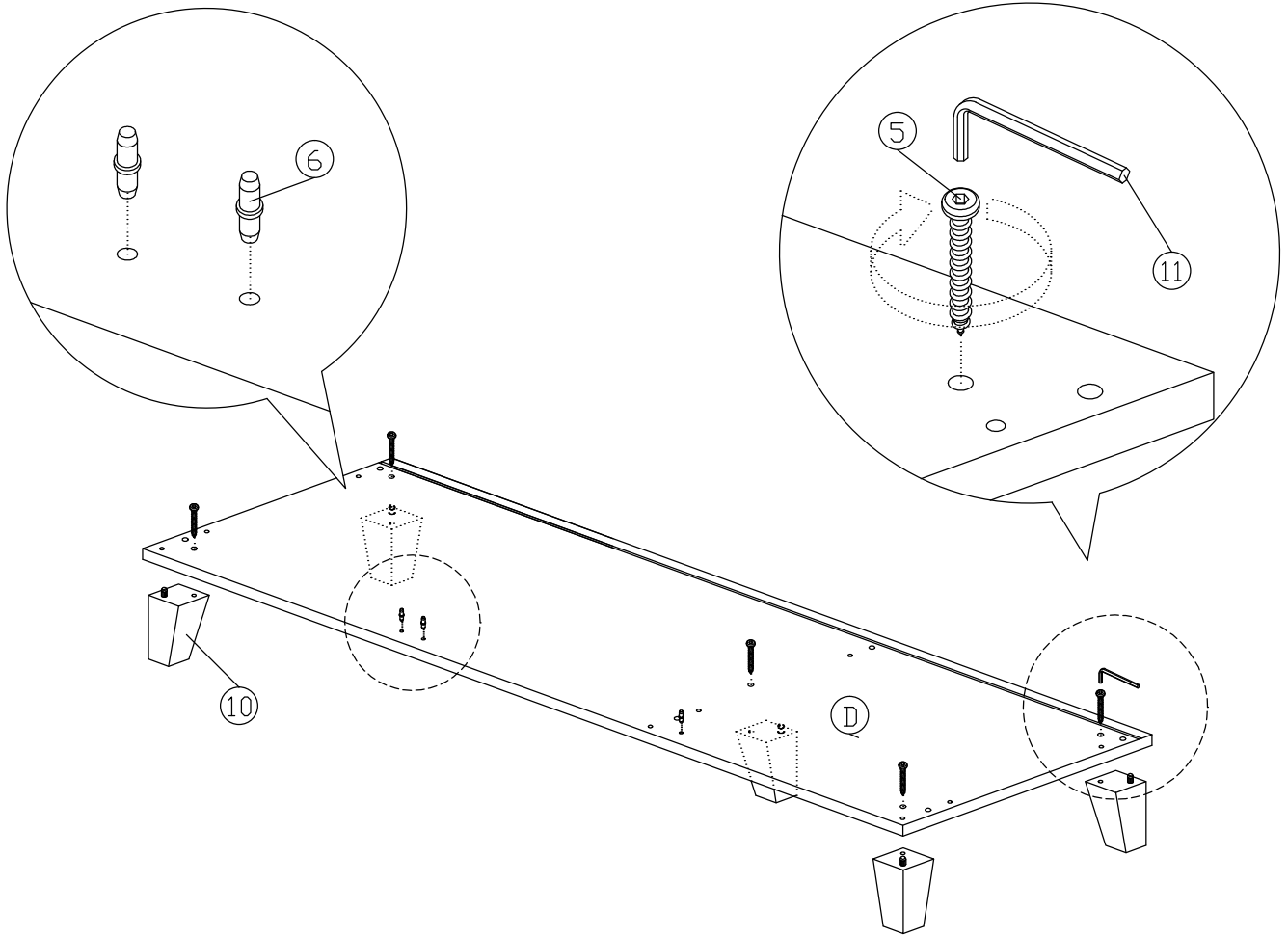

Step 4

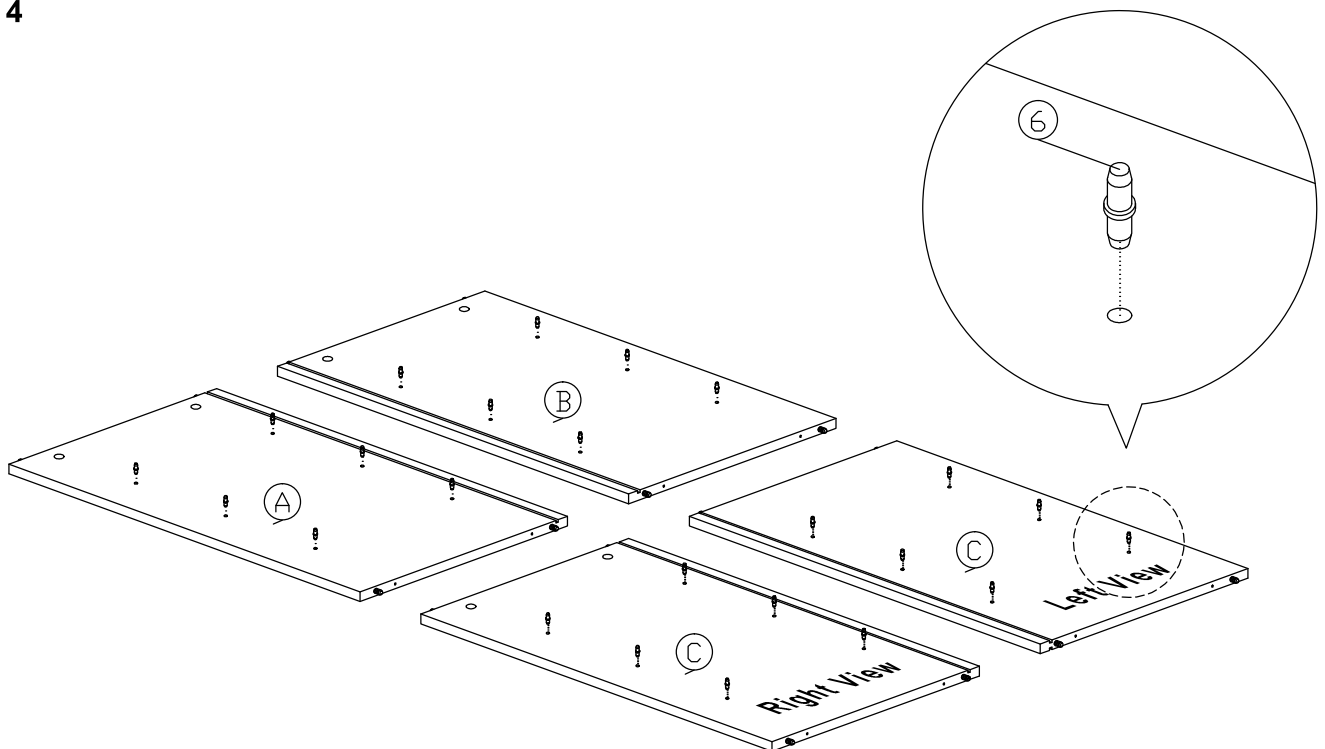

Assembly Instruction

Step 5

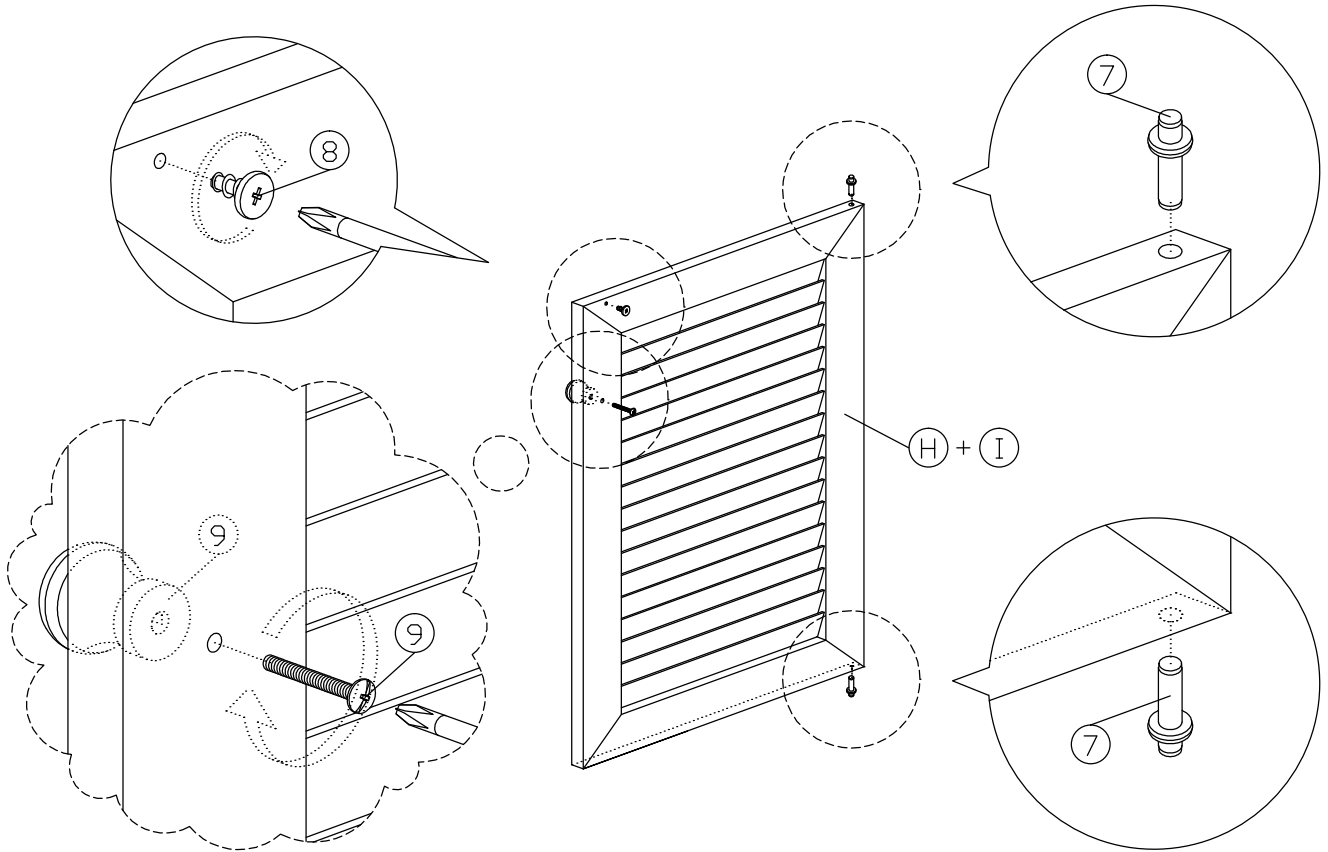

Step 6

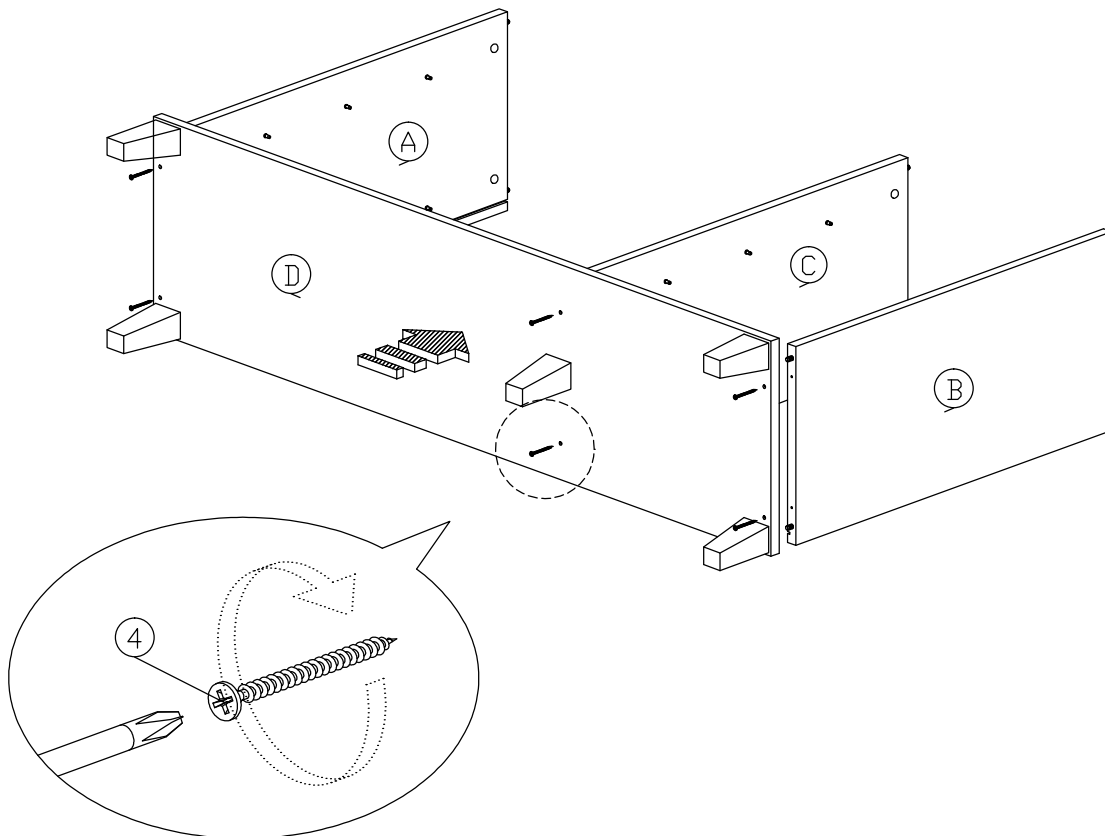

Assembly Instruction

Step 7

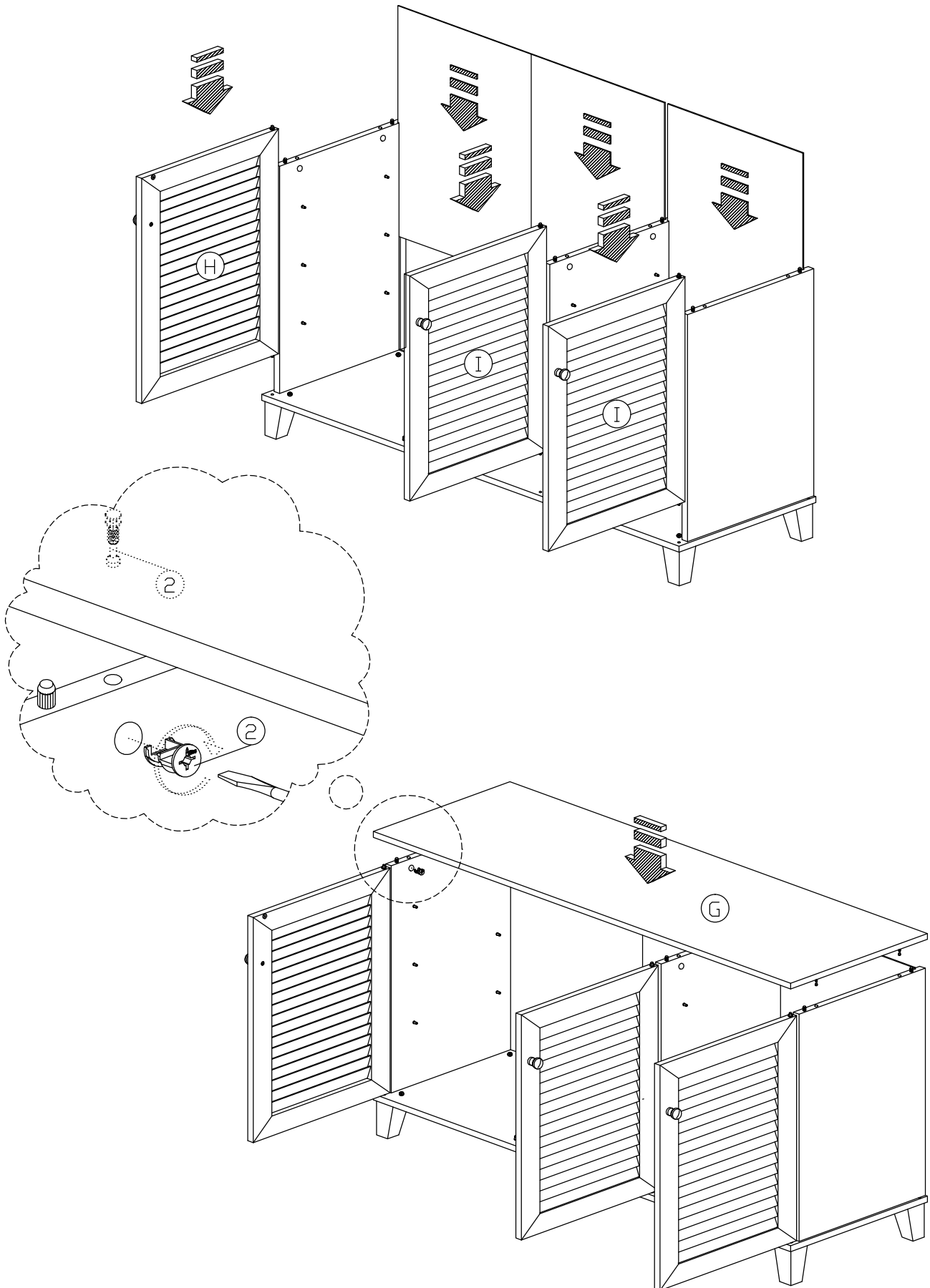

Assembly Instruction

Step 8

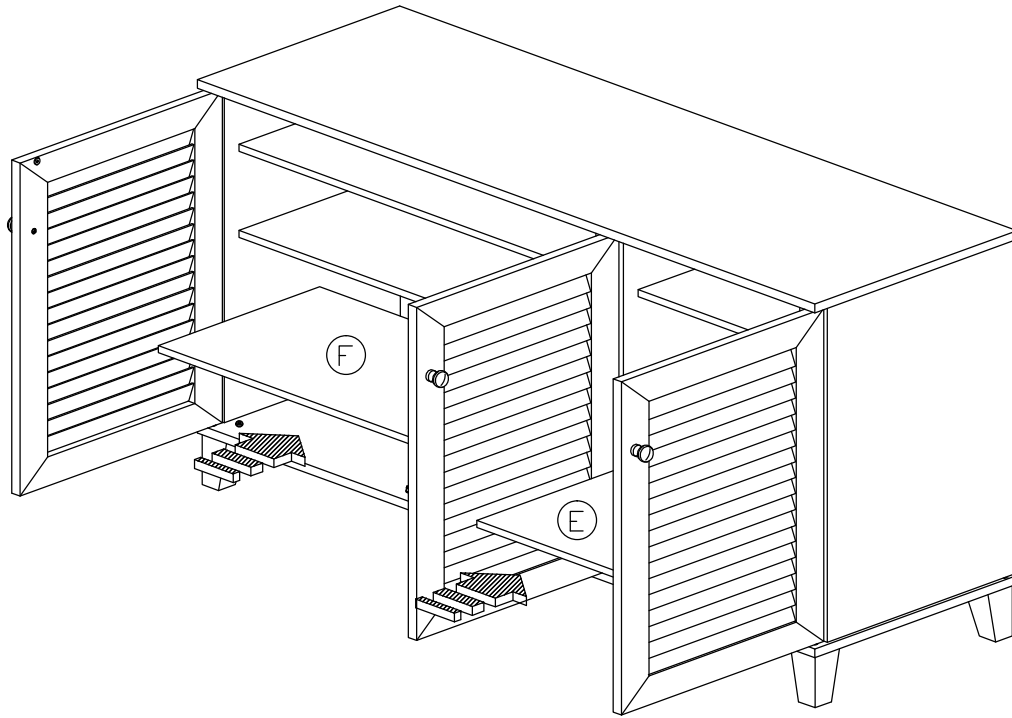

Step 9

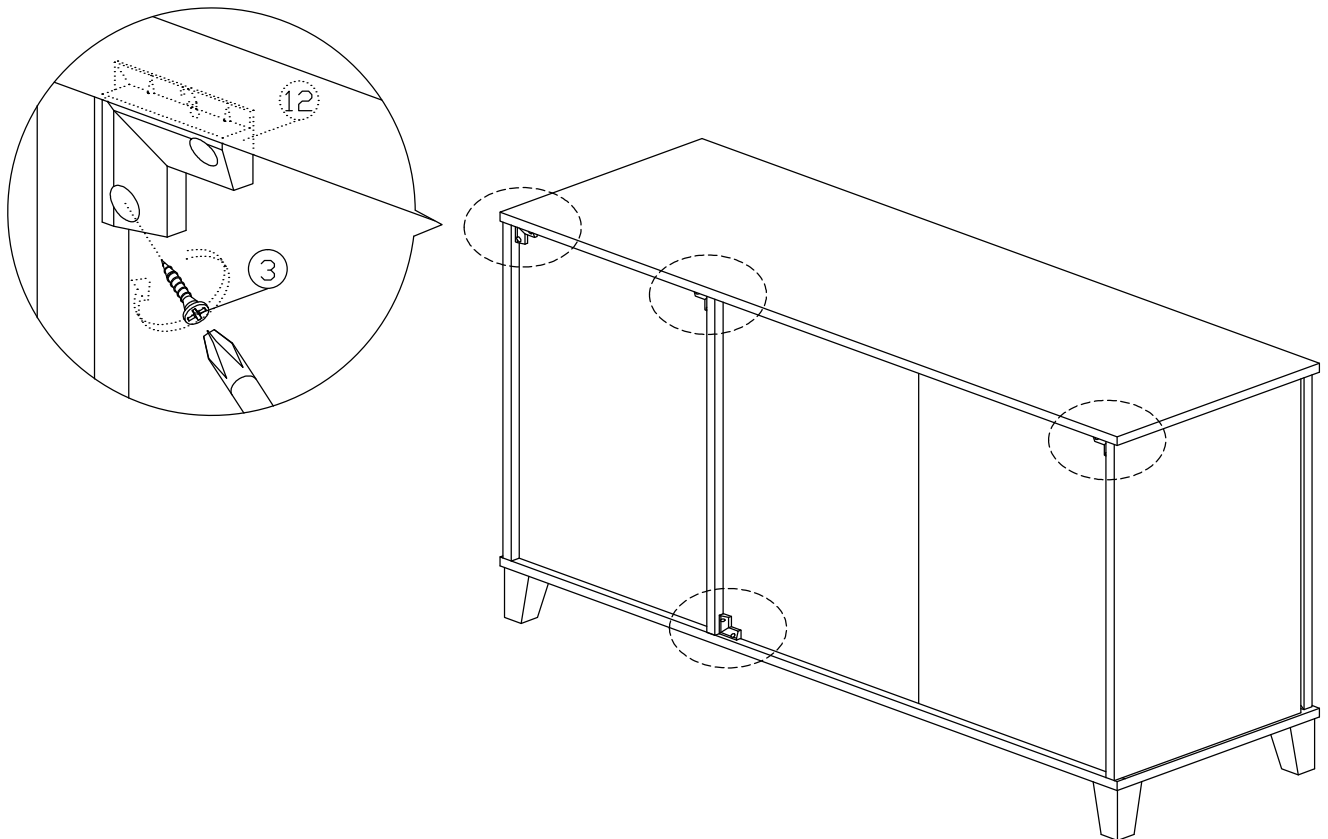

FURNITURE TIPPING RESTRAINT

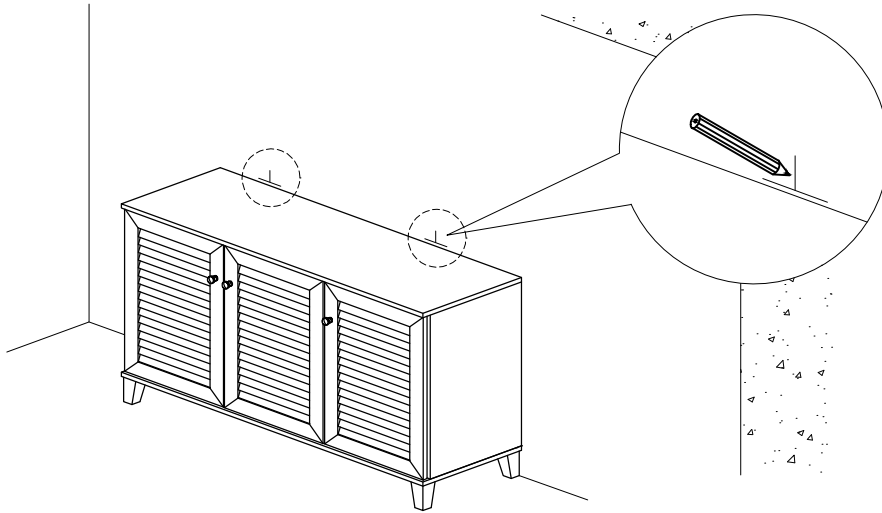

1. First mark the wall with pencil as in diagram.

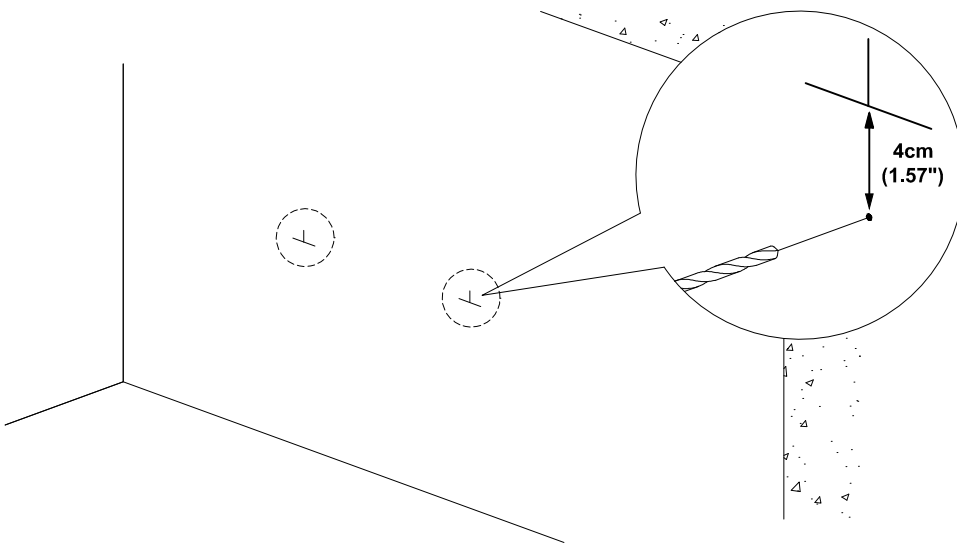

2. Drill small hole at the pencil mark.

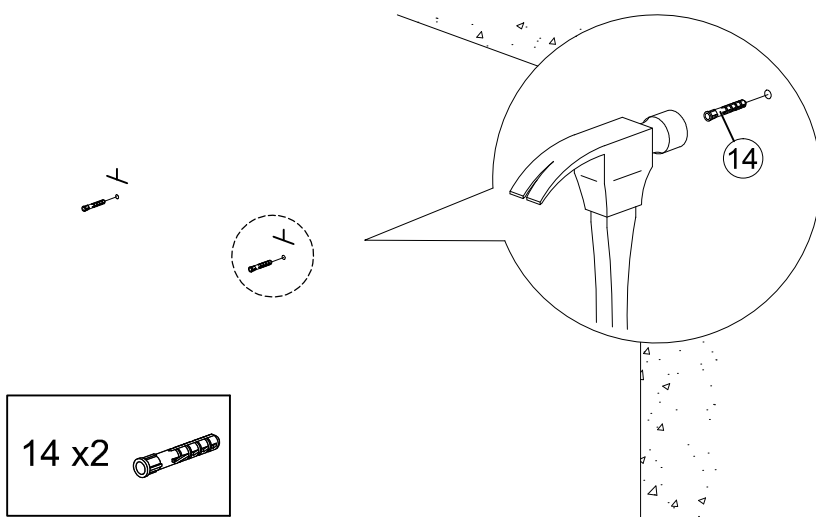

3. Insert plastic wall plug (14).

FURNITURE TIPPING RESTRAINT

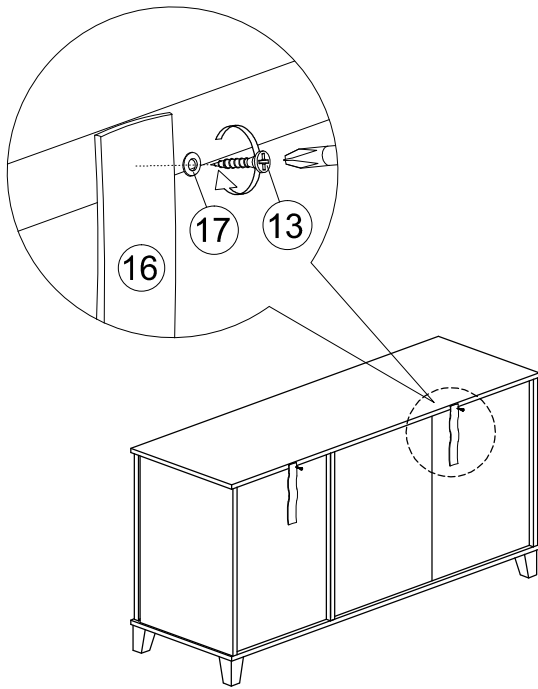

4. Add safety strap (16), washer (17) using 3.5x15mm screw (13) to back of cabinet.

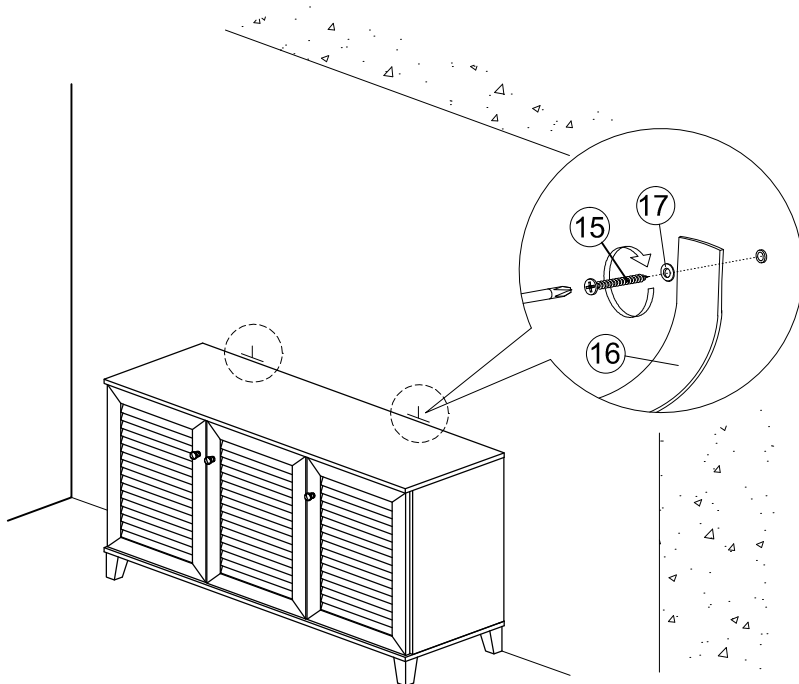
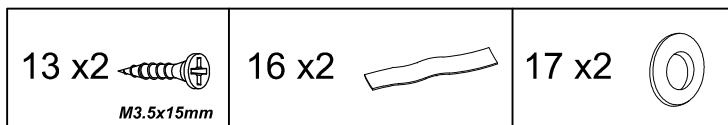

5. Finally, attach safety strap (16) and washer (17) using 4x30mm screw (15) to the wall.

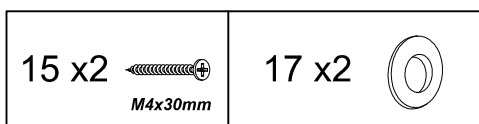

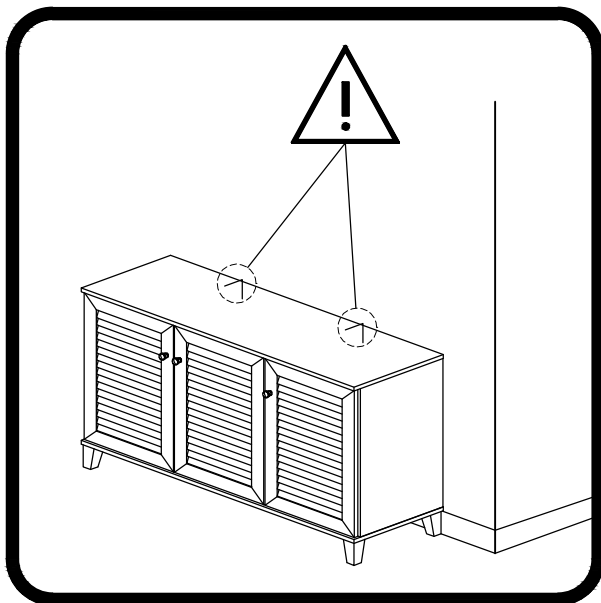

⚠ WARNING	
	<p>Children have died from furniture tipover. To reduce the risk of furniture tipover:</p> <ul style="list-style-type: none">• ALWAYS install tipover restraint provided.• NEVER put a TV on this product.• NEVER allow children to stand, climb or hang on drawers, doors, or shelves.• NEVER open more than one drawer at a time.• Place heaviest items in the lowest drawers. <p><i>This is a permanent label. Do not remove!</i></p>
	



Anti-Topple hardware included for added safety and stability