

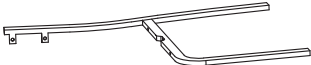







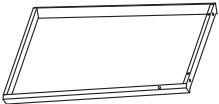
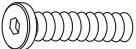
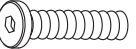
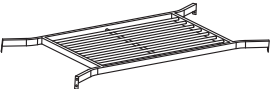
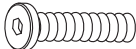

A		1PC	H		4PCS
			I		4PCS
B		2PCS	J	 M6×50mm	8PCS
			K	 M6×35mm	16PCS
C		1PC	L	 M6×25mm	4PCS
D		2PCS	M	 M6×12mm	28PCS
E		4PCS	N	 M6×30mm	4PCS
F		4PCS	O	 M6	4PCS
G		4PCS	P	 M6	1PC
			Q	 4mm	1PC

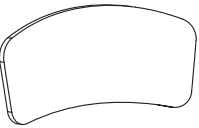
ASSEMBLY INSTRUCTION  
 \*\*\* DO NOT TIGHTEN SCREWS UNTIL COMPLETELY ASSEMBLED\*\*\*

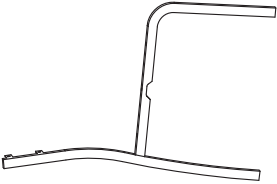

**1** Step 1-Use screws(Part M/J)to connect table feet(Part B) and shelf (Part C)  
 Use screws(Part J)to connect table feet(Part B) and cross-bars (Part D)as a table metal frame

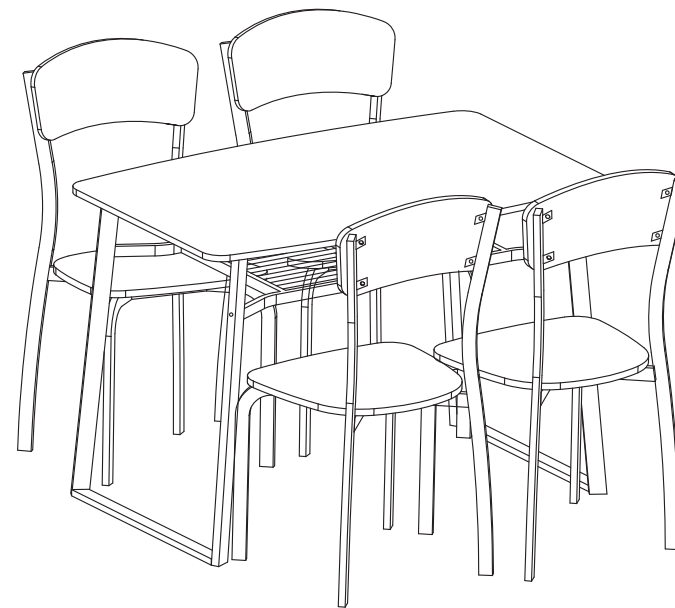
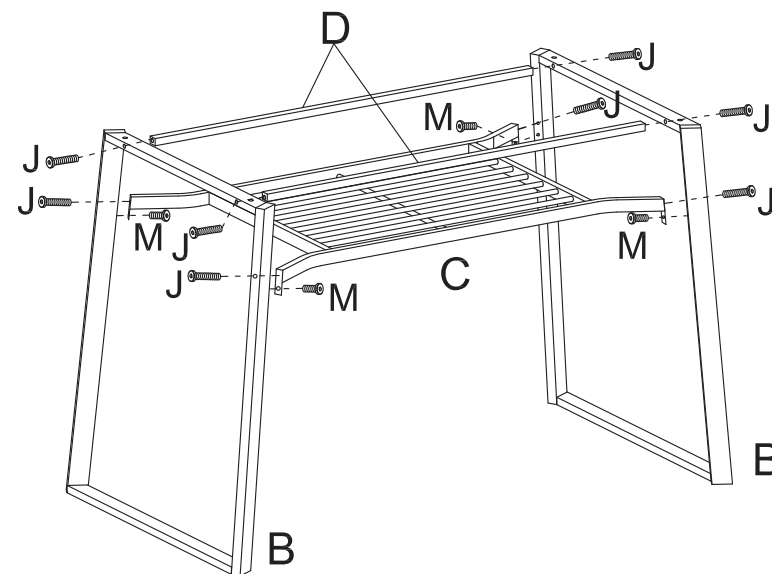

**2** step 2-Use screws(Part L)to connect table metal frame to the table top (Part A)

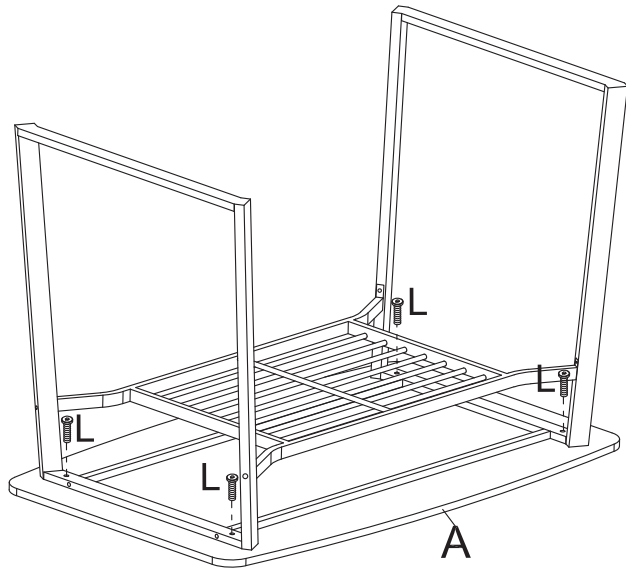

**3** Step 3-Use screws(Part N/O)to connect chair feet(Part G/H)  
Use screws(Part M) to connect cross-bars(Part I) as a metal chair frame

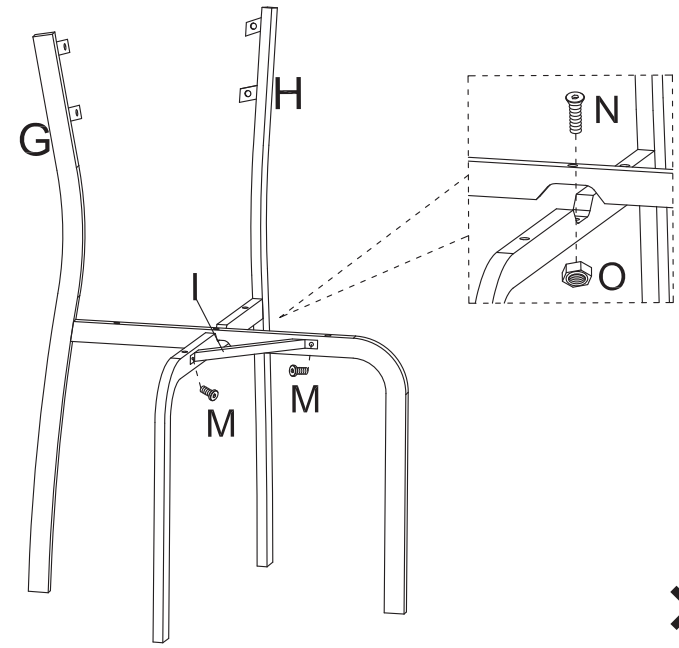

**x4**

**4** step 4-Use screws(Part K) to connect the chair metal frame to the chair seat(Part F)  
-Use screws(Part M)to connect backrest(Part E) to the chair metal frame

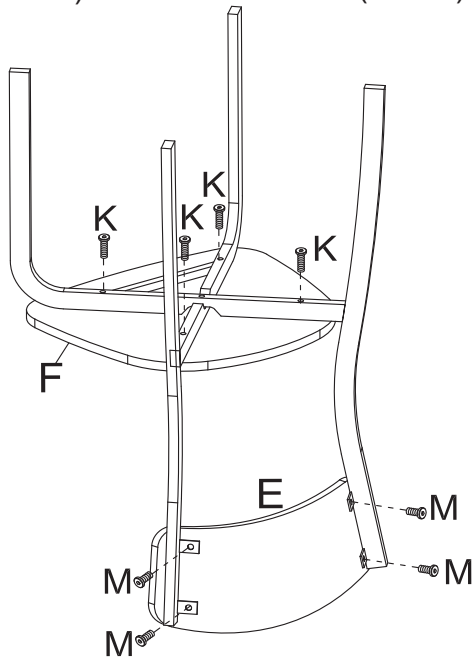

**x4**

**5**

