











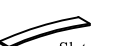

ASSEMBLY INSTRUCTION

A		1 pc
B		1 pc
C		2 pcs
D		4 pcs
E		2 pc
F		4 pcs
G		42 pcs
H		28 pcs
I		28 pcs
J		4 pcs
K		8 pcs
L		1 pc
M		4 pcs
N		8 pcs
O		4 pcs
P		4 pcs
Q		1 pc
R		4 pcs

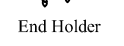

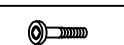
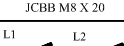
Step 5: Affix the Stiffener Slat (Q) to the side rail support wood and the center rail (E) . Tighten all the 4 corner , follow by assembly of the slat holders with LVL slats as shown.

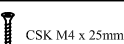
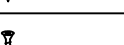
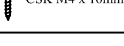
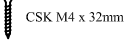
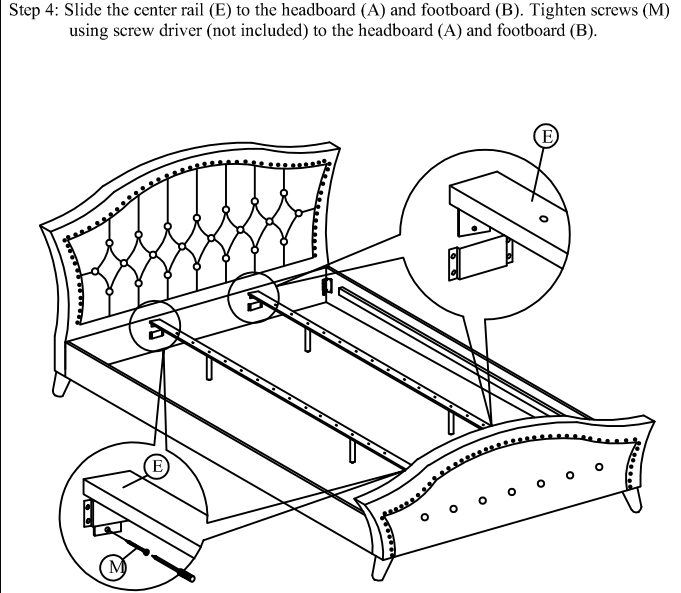
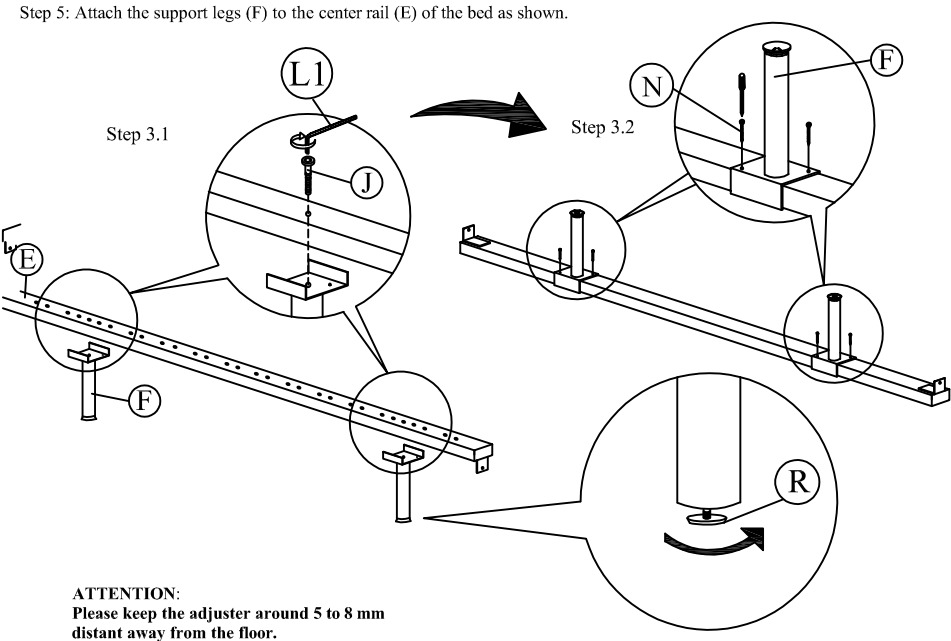
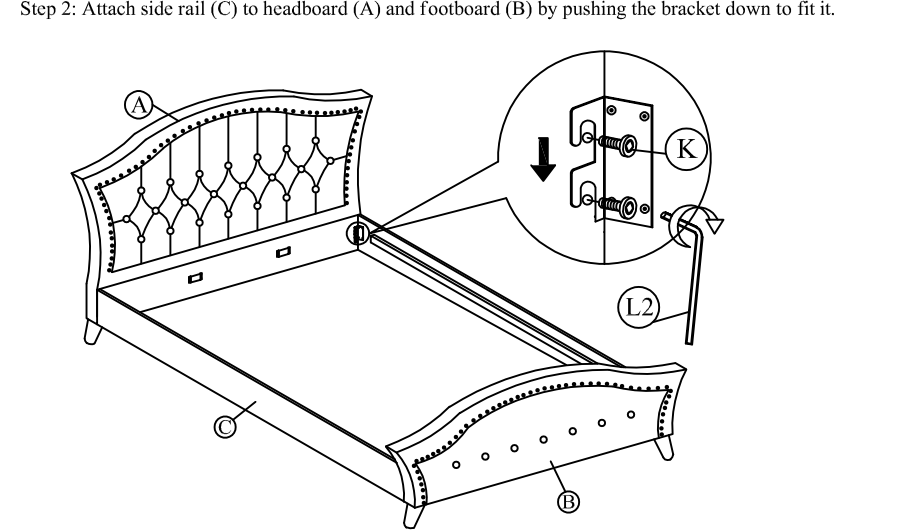
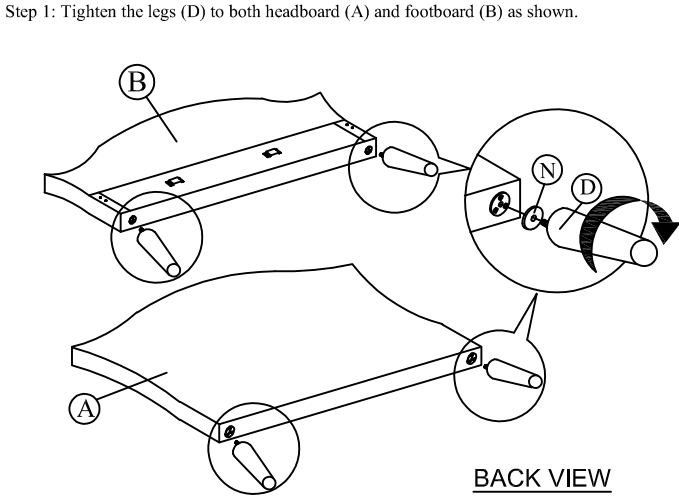