

Read this instruction carefully. See hardware and furniture part list for guidance. Be sure all parts are complete, before you assemble. Place all wooden furniture parts on a clean and flat soft surface to prevent from being scratched. Follow the figure to start assembling.

CAUTIONS : 1. Do not FULLY - TIGHTEN the nut or nut bolt until all nut or bolt is ready assembled.
 2. Do not OVER - TIGHTEN the nut or bolt to avoid causing damages to the thread.
 3. Keep all hardware parts out of reach of children.

NOTE : THE LIST AND QUANTITY SHOWN ARE FOR 1 UNIT ASSEMBLY.

PART LIST		
ITEM	DESCRIPTION	QTY
A	BACK	1pc
B	SEAT	1pc
C	ARM	2pcs
D	FRONT RAIL	1pc

PART LIST		
ITEM	DESCRIPTION	QTY
1	JCBB Bolt M8 x 60mm	8pcs
2	JCBB Bolt M8 x 80mm	2pcs
3	M8 Flat Washer	4pcs
4	M8 Spring Washer	4pcs
5	Wood Dowel M10 x 40mm	2pcs
6	M8 Bran Nut	2pcs
7	Wood Button Dia 18.5mm	6pcs
8	M5 Allen Key (Ball Shape)	1pc
9	Wood Screw M4 x 50mm	2pcs

STEP 1

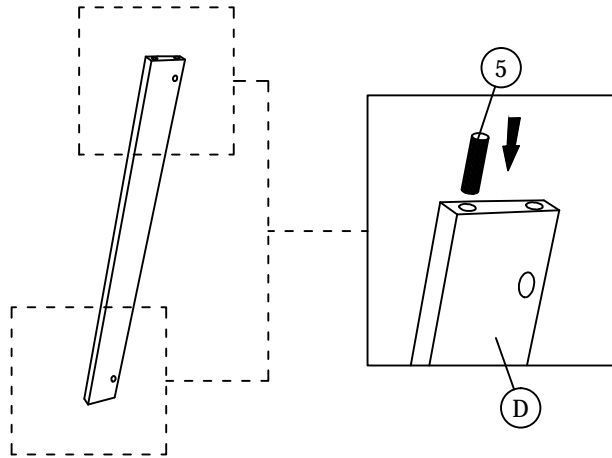

STEP 2

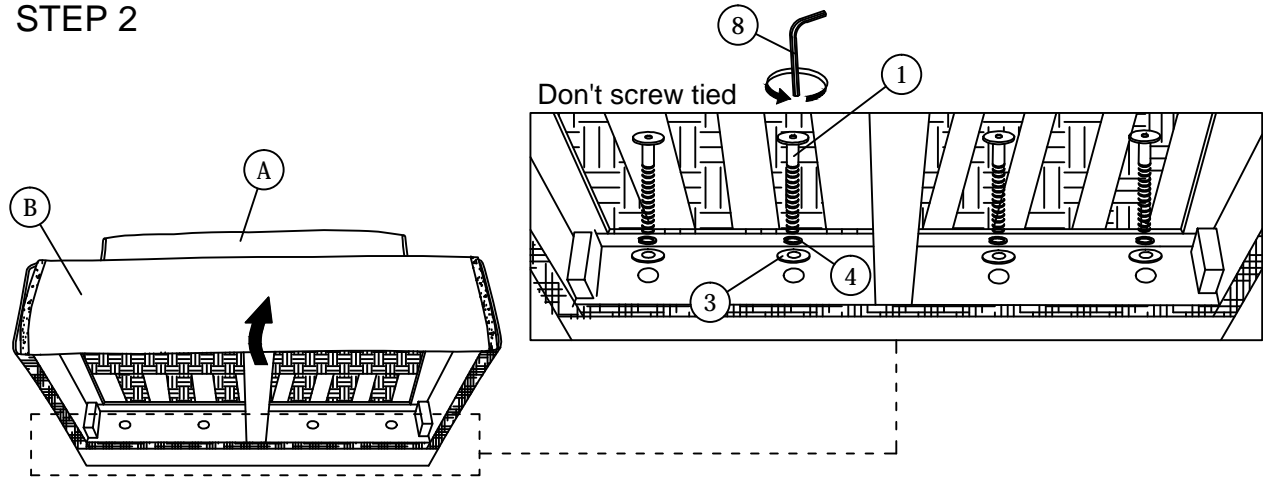

STEP 3

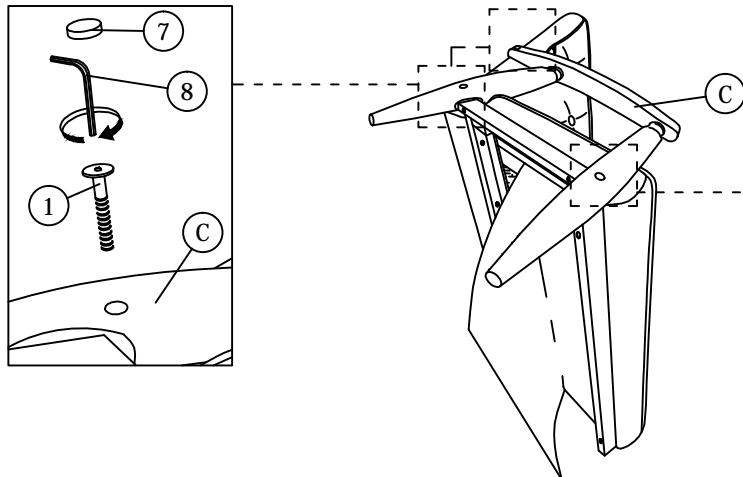

STEP A

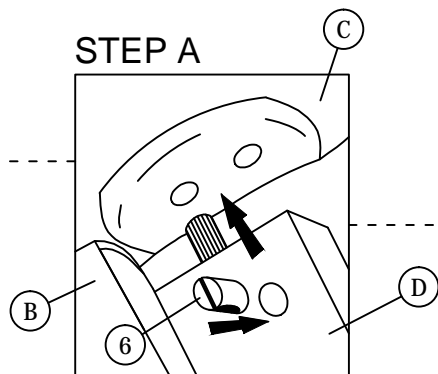

STEP B

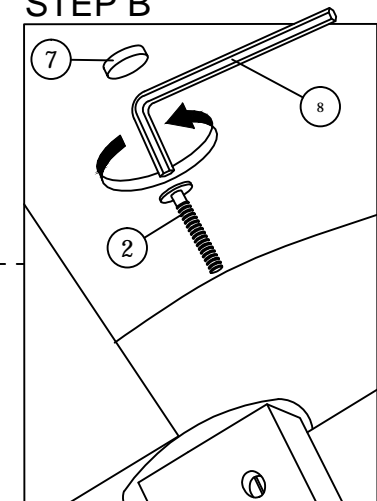

STEP 4

STEP B

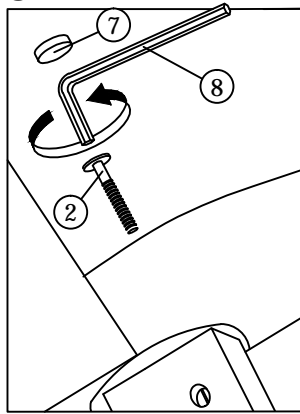

STEP A

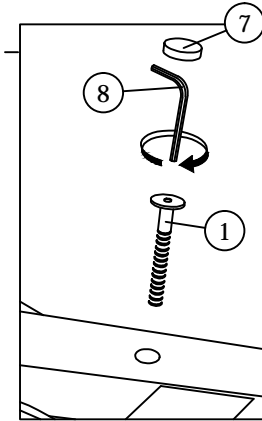
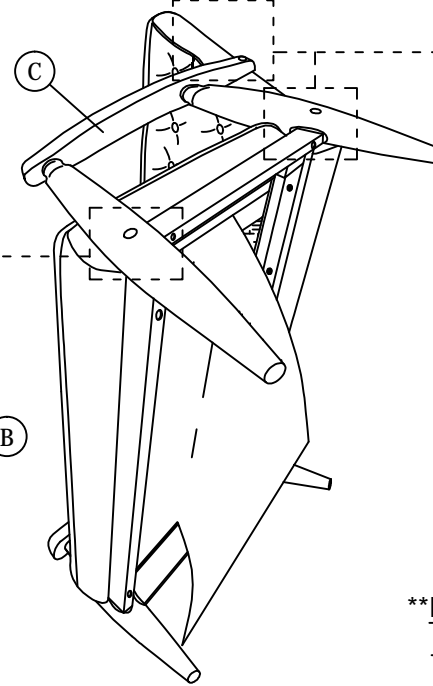
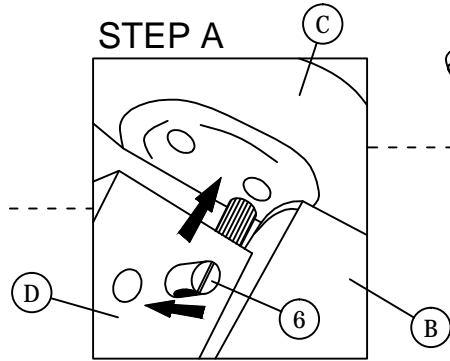

****Finish step 4,
Please screw tied the step 2 bolt.**

STEP 5

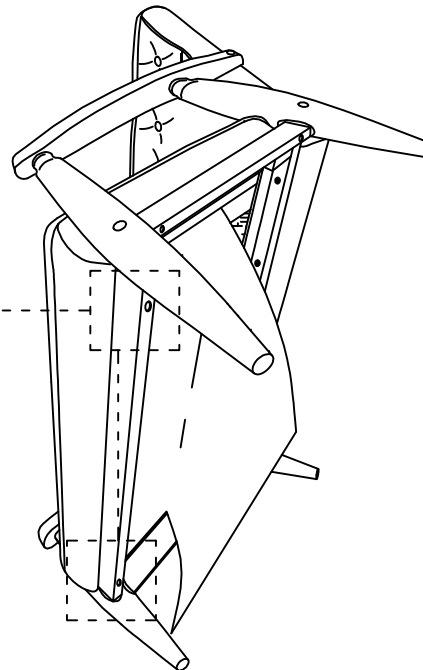
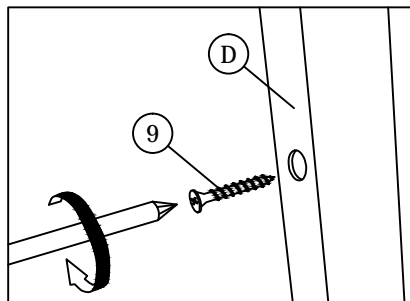

STEP 6

