











ASSEMBLY INSTRUCTIONS

B6910-Q-HBFB / B6910-KQ-RAIL

AMALIA QUEEN BED

CRWN

(BOX 1) - BOX OF QUEEN BED

PARTS LIST				HARDWARE LIST			
NO.	DESCRIPTION	SKETCH	QTY	NO.	DESCRIPTION	SKETCH	QTY
1	HEADBOARD PANEL		1	A	JCBB (M8 x 40mm) W/FLAT WASHER & SPRING WASHER		6
2	HEADBOARD LEG (L/R)		2	B	JCBB (M8 x 20mm) W/FLAT WASHER		8
3	FOOTBOARD		1	C	ALLEN KEY (M5)		1
4	SLAT		3	D	PANHEAD (M4 x 32mm)		6
5	VERTICAL LEG		3	E	SCREW DRIVER (*)		1

*The manufacturer does not provide item E.

(BOX 2) - BOX OF KING / QUEEN SIDE RAIL

PARTS LIST			
NO.	DESCRIPTION	SKETCH	QTY
6	SIDE RAIL		2

IMPORTANT NOTE :

- * Place all wooden parts on a clean and smooth surface such as a rug or carpet to avoid the parts from being scratched.
- * Check to be sure that you have all parts and hardware.
- * Remove all wrapping materials, including staples & packing straps before you start to assemble.
- * Do not tighten all screws/bolts until all completely assembled.
- * Keep all hardware parts out of reach of children.

BACK VIEW

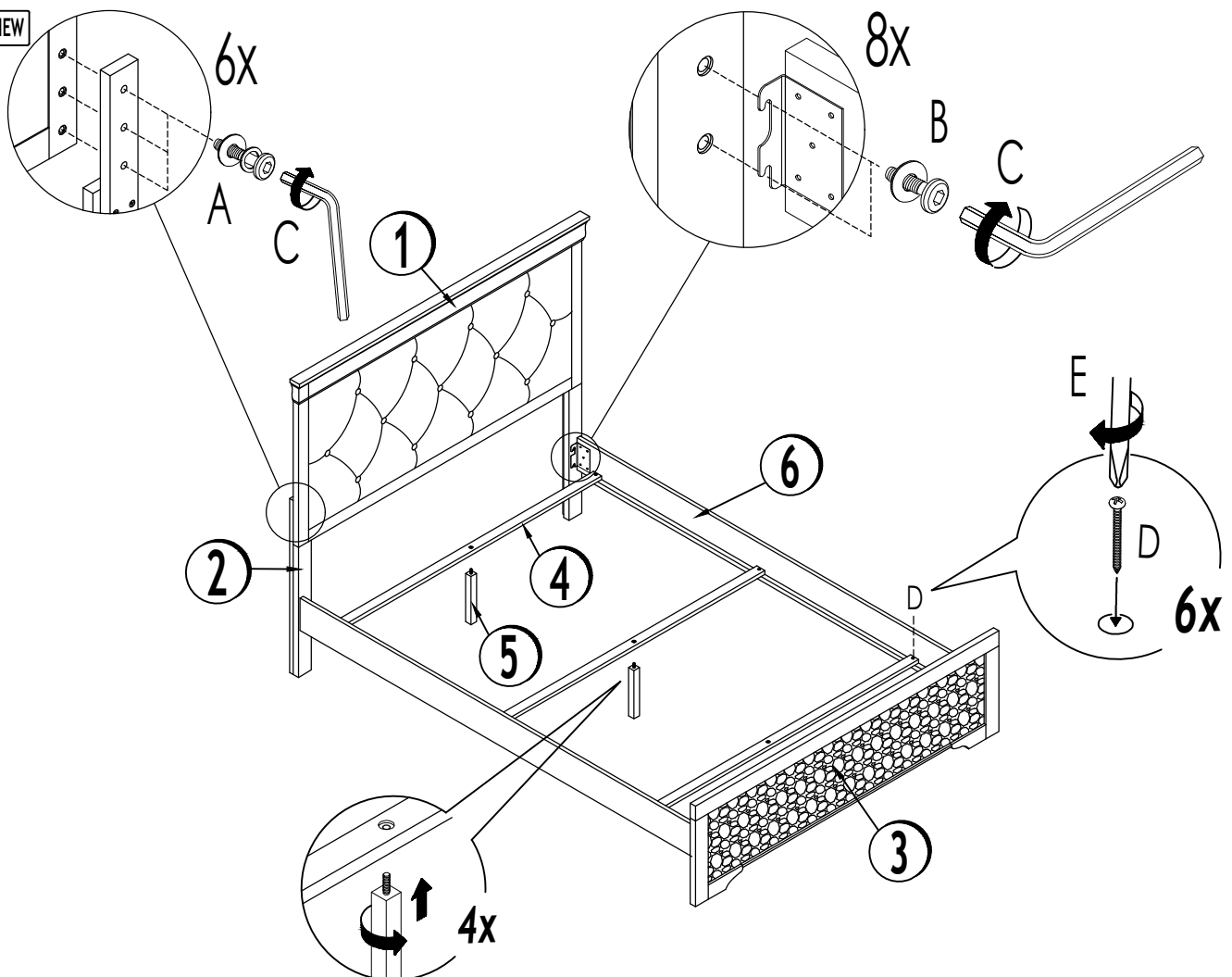

THE HARDWARE IS LOCATED IN THE PACKING ITEMS