

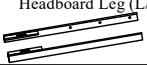



ASSEMBLY INSTRUCTIONS

CROWNMARK MODEL:
B4100-Q-HB /Q- FB /
QK-SR
QUEEN BED (4 + 4)

(BOX 1) HEADBOARD



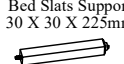

No	ITEM	Qty
A	Headboard 	1 pc
B	Headboard Leg (L/R) 	2 pcs
C	HB Bottom Support 	1 pc

(BOX 2) FOOTBOARD

D	Footboard 	1 pc
E	Bed Slats 	4 pcs
F	Bed Slats Support 30 X 30 X 225mm 	4 pcs

(BOX 3) SIDE RAILS

NO	ITEM	Qty
G	Side Rails 	2 pcs

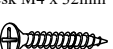
NO	ITEM	Qty
1	JCBC M6 x 30mm 	6 pcs
2	SPRING WASHER 1/4" RBW 	6 pcs
3	FLAT WASHER 1/4"ID x 19mm OD BLK 	6 pcs
4	ALLEN KEY M4 x 65mm BLK 	1 pc
5	ALLEN KEY M5 x 65mm BLK 	1 pc
6	Csk M4 x 32mm 	10 pcs

- STEP 1**
- 1.1 Open the back headboard cover cloth by unzip them as diagram shown
 - 1.2 Attach Head Board Leg (B) & (C) to Head Board (A) as shown using JCBC BOLT (1) with Spring Washer (2), Flat washer (3) and securing with ALLEN KEY (4).

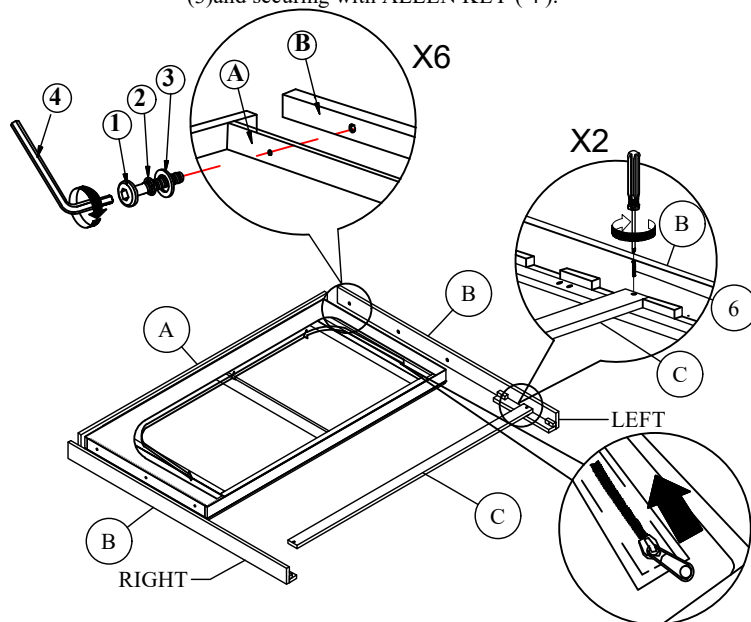

- STEP 2** Hook SIDE RAIL (G) TO HEAD BOARD (A) closely and push down to fit. repeat step 2 with other end of rail to hook onto FOOTBOARD (D).

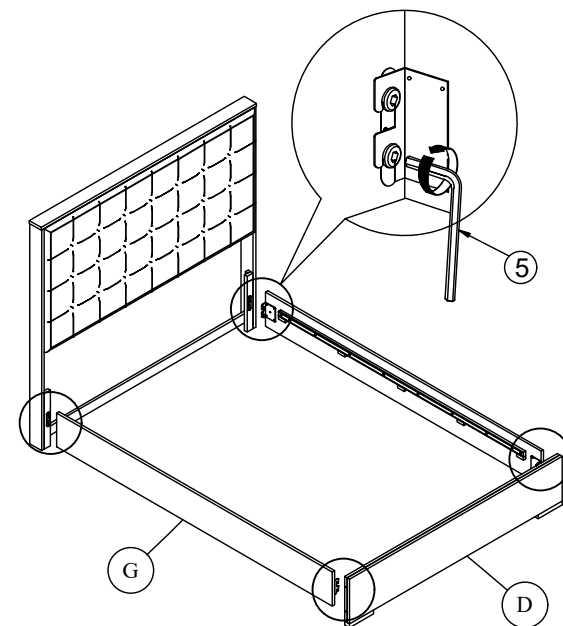

- STEP 3** Tighten the 4 Corner with Allen Key (5). Fix the Bed Slat Support Leg (F), to Bed Slat (E) as shown . Install the bed slat (E) to side rail (G) and tighten with Csk Screw (6) as per diagram shown. NOTE: THE SETUP MUST DONE AT THE DECIDED LOCATION FOR THE BED TO OBTAIN PERFECT STABILITY)

