







ASSEMBLY INSTRUCTION

CROWNMARK
MODEL : B1600 KING BED

(BOX 1)
BOX OF HEADBOARD

NO	ITEM	QTY
A	Headboard 	1 PC
B	Finial 	1 PC
C	Stretcher 	1 PC

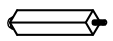

(BOX 2)
BOX OF FOOTBOARD

NO	ITEM	QTY
F	Footboard 	1 PC
G	Bed slat 	4 PCS
H	Support leg 	8 PCS
I	Bun foot 	2 PCS

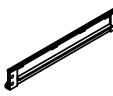







(BOX 3)
BOX OF SIDE RAIL

NO	ITEM	QTY
K	Side Rail 	2 PCS

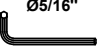
(BOX 4)
BOX OF HEADBOARD LEG

NO	ITEM	QTY
D	Headboard KD Leg (L/R) 	2 PCS
E	Bun foot 	2 PCS

(BOX 1)
HARDWARE LIST

NO	ITEM	QTY
1	Ø5/16" x 18 x 1-3/4" L 	10 PCS
2	Ø5/16" x 18 x 1-1/2" L 	2 PCS
3	Ø5/16" 	1 PC
4	Ø5/16" x 3-1/2" L 	8 PCS
5	5/16" 	8 PCS
6	5/16" 	8 PCS
7	12mm 	1 PC
8	1-3/16" 	8 PCS

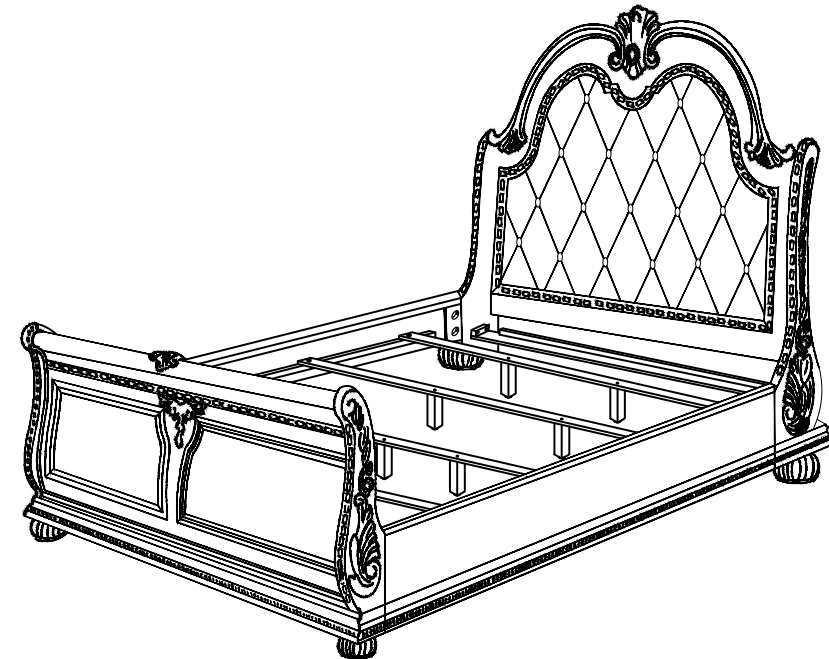

NOTE : DURING ASSEMBLY, DO NOT FULLY TIGHTEN ANY HARDWARE UNTIL THE COMPLETE UNIT HAS BEEN ASSEMBLED.

"THE HARDWARE IS LOCATED IN THE PACKING ITEMS"

NOTE : MUST TIGHTEN SCREWS PERIODICALLY WITH USE SCREWS WILL BECOME LOOSE.CHECK TIGHTNESS OF ALL SCREWS EVERY 6-8 WEEKS.

STEP 1

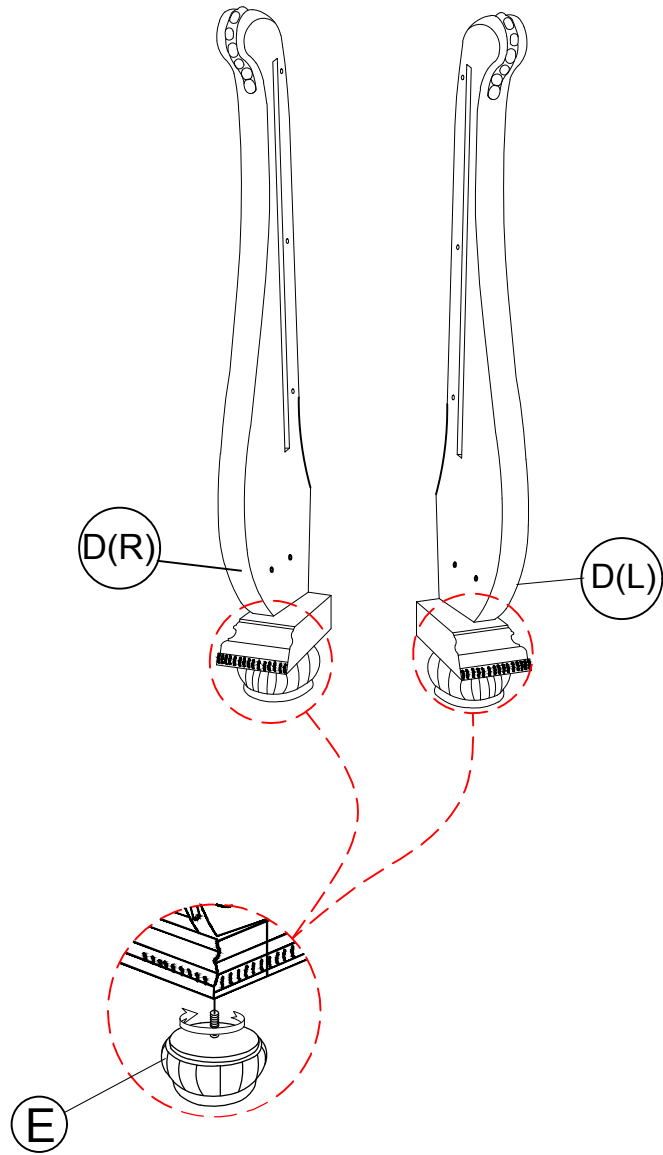

STEP 2

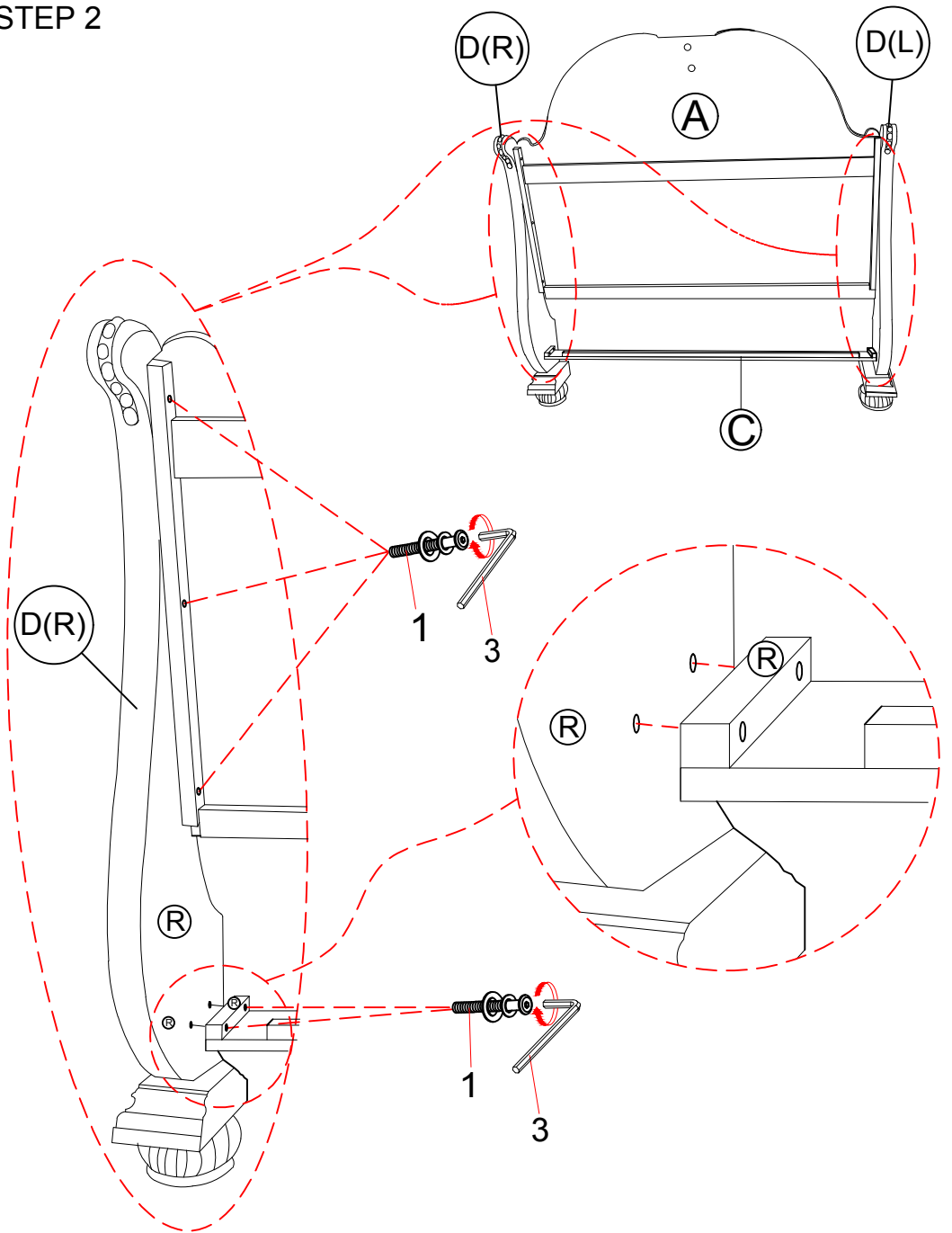

STEP 3

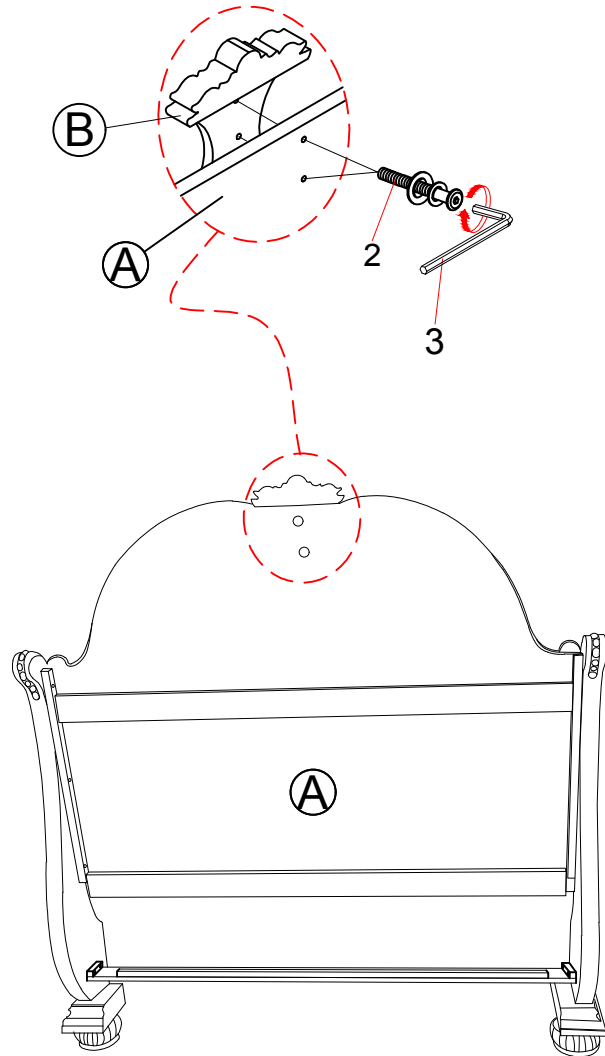

STEP 4

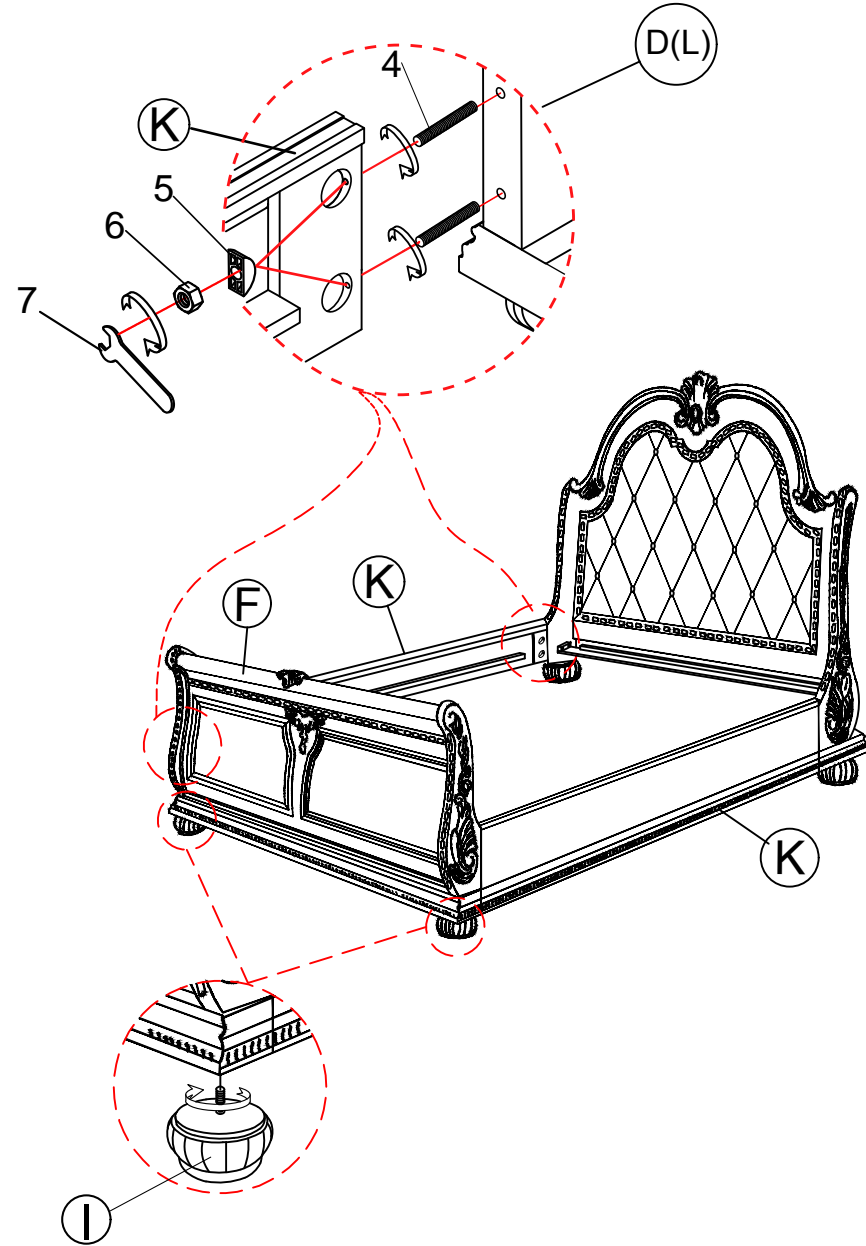

STEP 5

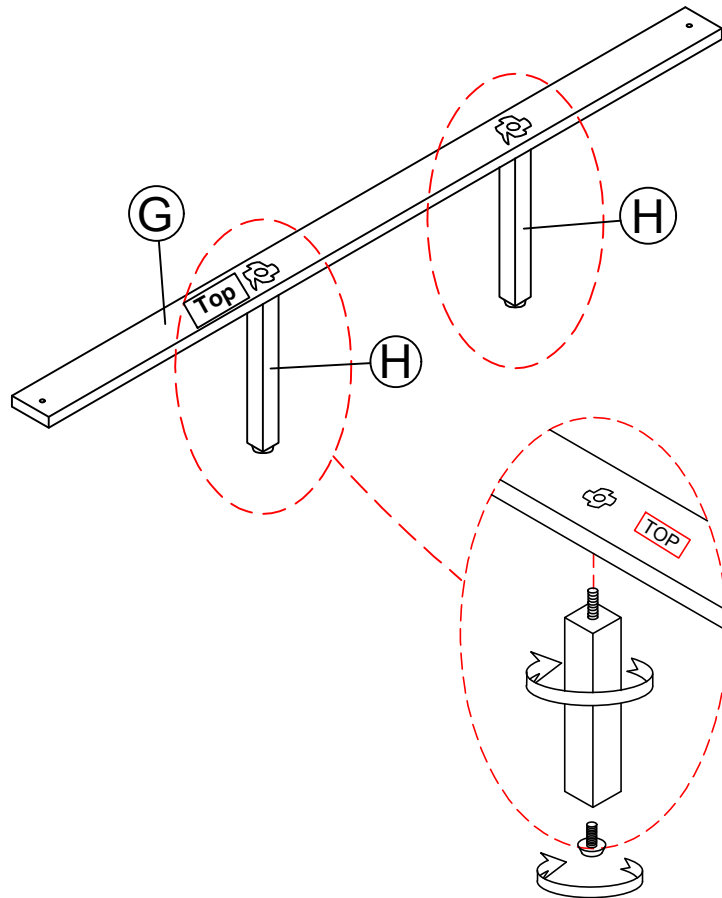

STEP 6
COMPLETED

