

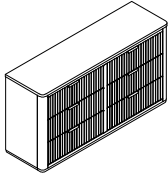
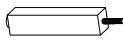
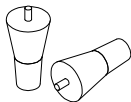

ASSEMBLY INSTRUCTIONS INSTRUCCIONES

B1400-1 DRESSER B1400-1 TOCADOR

PART LIST:

NO.	DESCRIPTION	OUTLOOK	QT.
1	DRESSER		1
2	SUPPORT LEG		1
3	BUN FOOT		4

ANTI-TIPPING HARDWARE LIST:

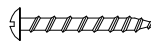
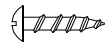
NO.	DESCRIPTION	OUTLOOK	SIZE	QT.
A	BRACKET		1/2"x1"L	2
B	TIE WRAP		#6x11-3/8"L	1
C	LONG SCREW		#8x2"L	1
D	SHORT SCREW		#8x5/8"L	1

STEP 1

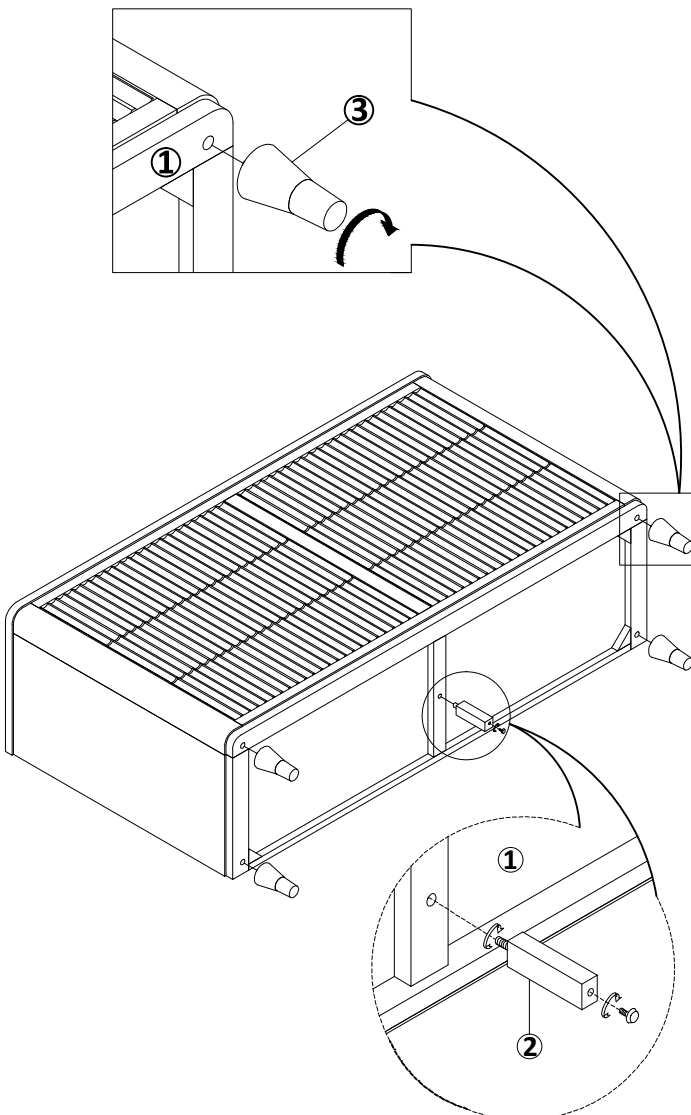

STEP 2

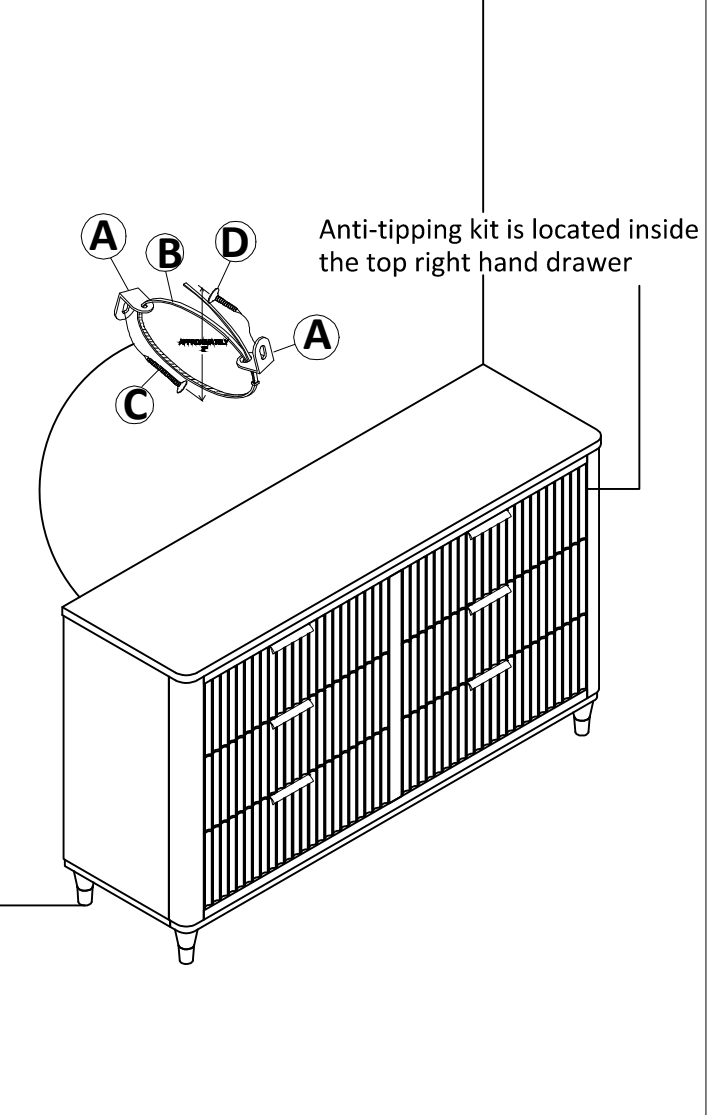

**DO NOT TIGHTEN ALL BOLTS UNTIL COMPLETELY ASSEMBLED.
NO APRETAR LOS TORNILLOS HASTA ARMAR COMPLETAMENTE.**