

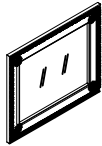



ASSEMBLY INSTRUCTION
INSTRUCCIONES

B1130-1&11 DRESSER/DRESSER TOP
B1130-1&11 TOCADOR/TOPE DE TOCADOR



BOX OF MIRROR

1		DRESSER TOP/ TOPE DE TOCADOR	1 PC/ PIEZA
2		DRESSER SUPPORT	2 PCS/ PIEZAS



HARDWARE LIST
BOX OF MIRROR

A		Ø1/4"x20x1-1/2"L	8 PCS/ PIEZAS
B		Ø1/4"	1 PC/ PIEZA

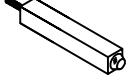
BOX OF DRESSER

3		DRESSER/ TOCADOR	1 PC/ PIEZA
4		LEGS	4 PCS/ PIEZAS
5		CENTER LEG	1 PC/ PIEZA

ANTI-TIP RES TRRAINT LIST

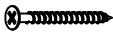
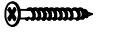
NO	COMPONENT		Q'TY
a	L BRACKET/L EQUERRE		2PCS/ PIEZAS
b	STRAP/LANIERE		1PC/ PIEZA
c	SCREW/VIS LONGUE #8*50MM		1PC/ PIEZA
d	SCREW/VIS COURTE #8*16MM		1PC/ PIEZA

STEP 1/PASO 1:

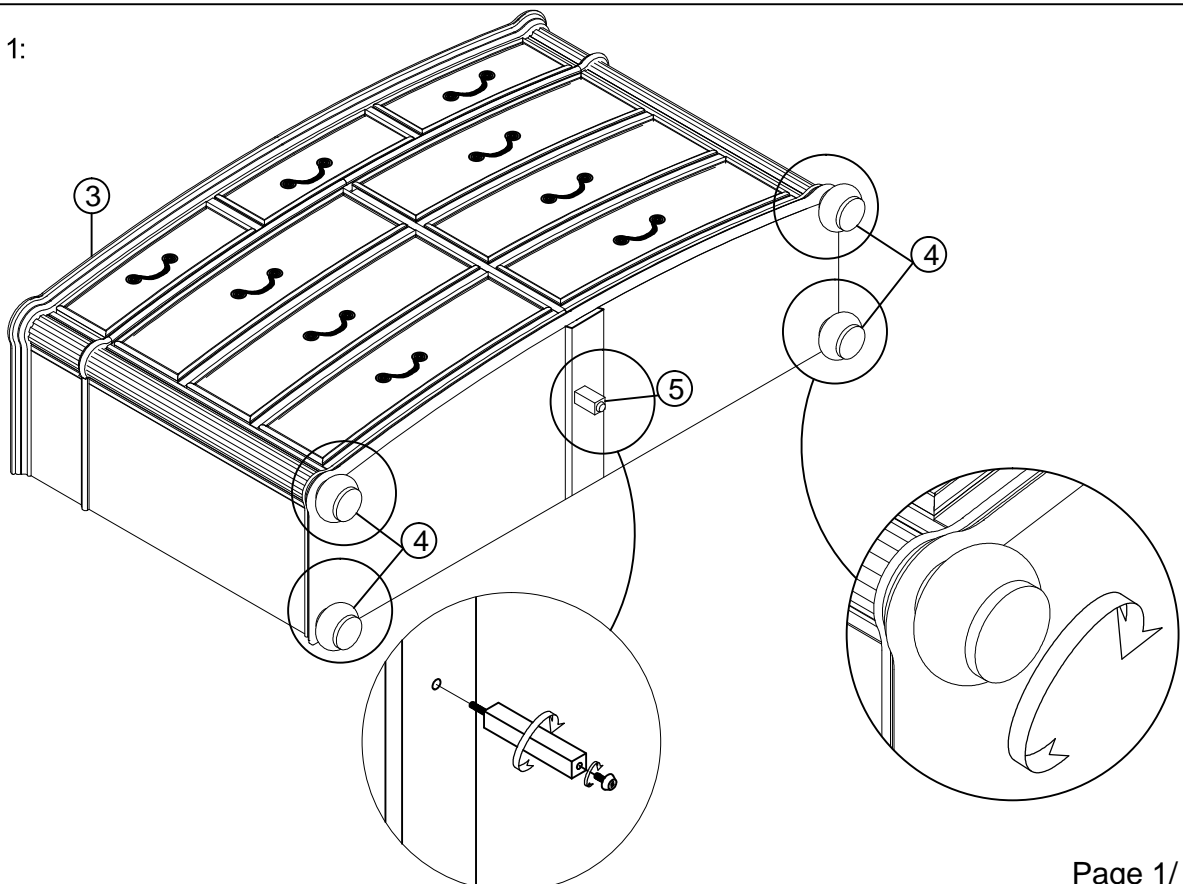

ASSEMBLY INSTRUCTION
INSTRUCCIONES

B1130-1&11 DRESSER/DRESSER TOP
B1130-1&11 TOCADOR/TOPE DE TOCADOR

STEP 2/ PASO 2:

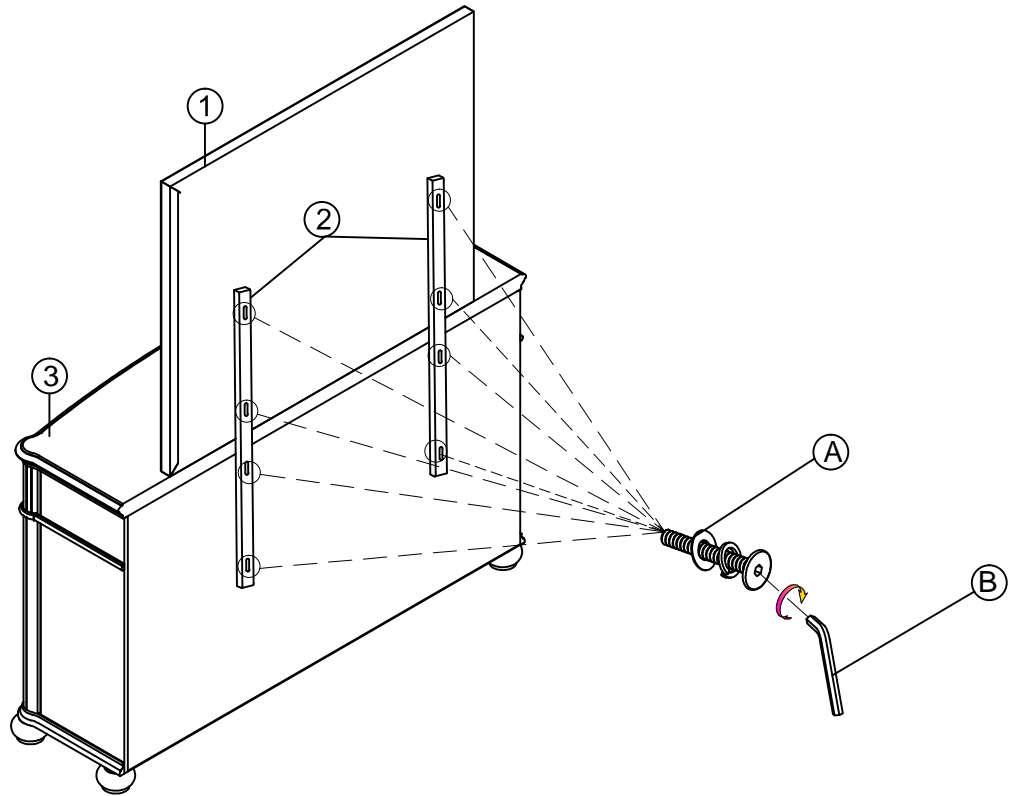

STEP 3/ PASO 3:

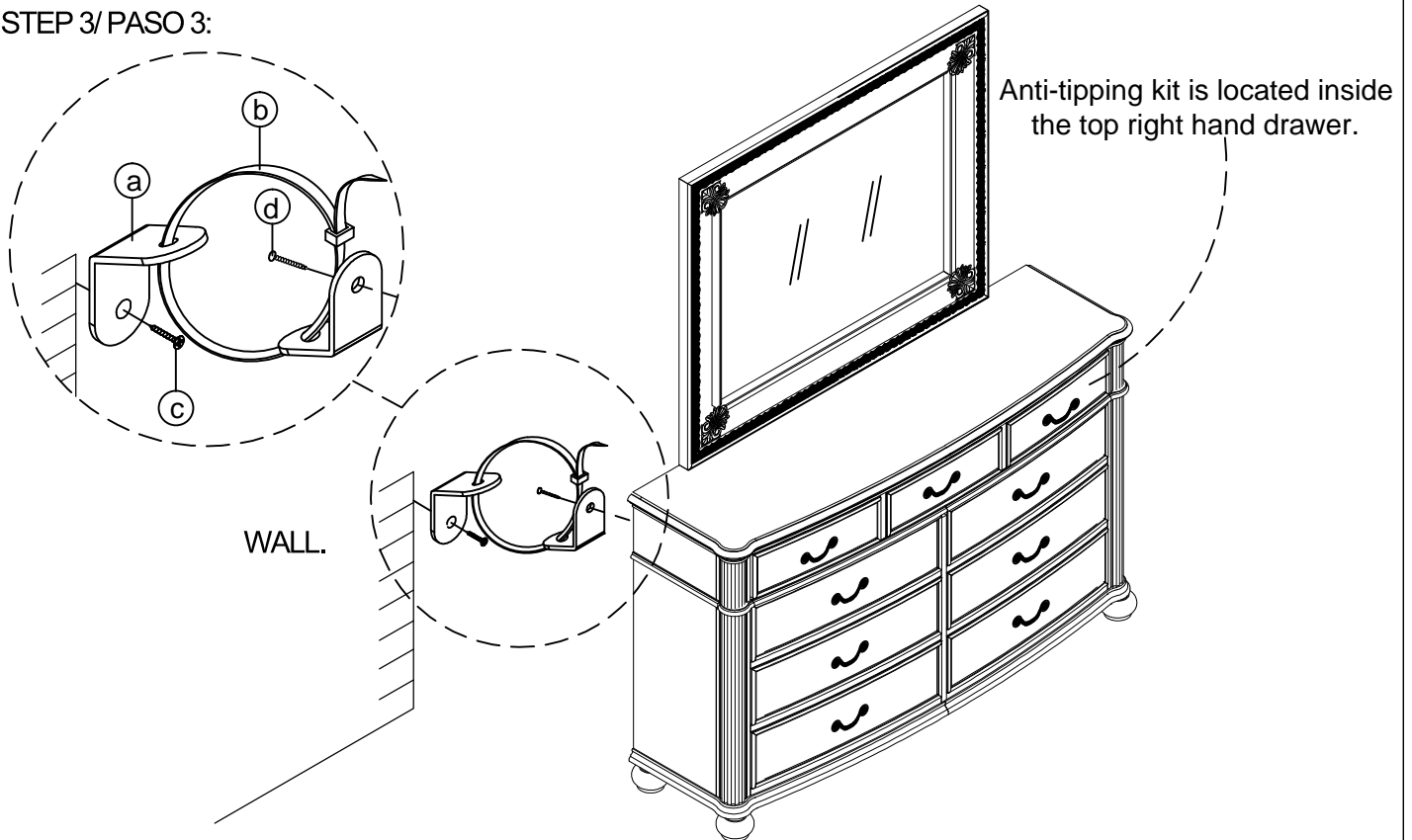

DO NOT TIGHTEN SCREWS UNTIL COMPLETELY ASSEMBLED !
NO APRETAR LOS TORNILLOS HASTA ARMAR COMPLETAMENTE