

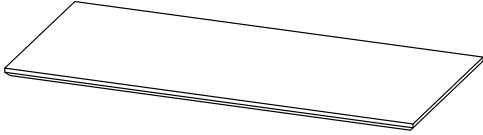

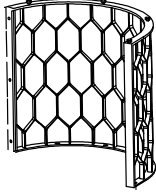



Product Assembly Instructions

CHAR-DT220-01

 <p>A : Top x1</p>	 <p>B : Leg x2</p>	 <p>C : Bolt M6*25mm x6</p>	 <p>F : Sleeve nut M6x15mm x3</p>
		 <p>D : Bolt M6*15mm x3</p>	
		 <p>E : Washer Ø18mm x9</p>	 <p>G : Allen key x2</p>

STEP 1

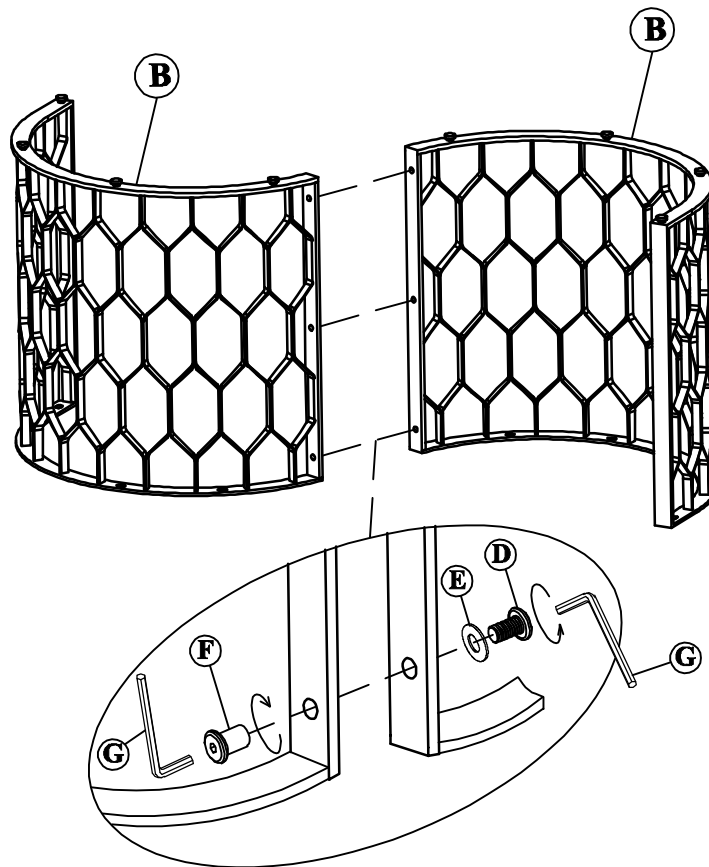

STEP 2

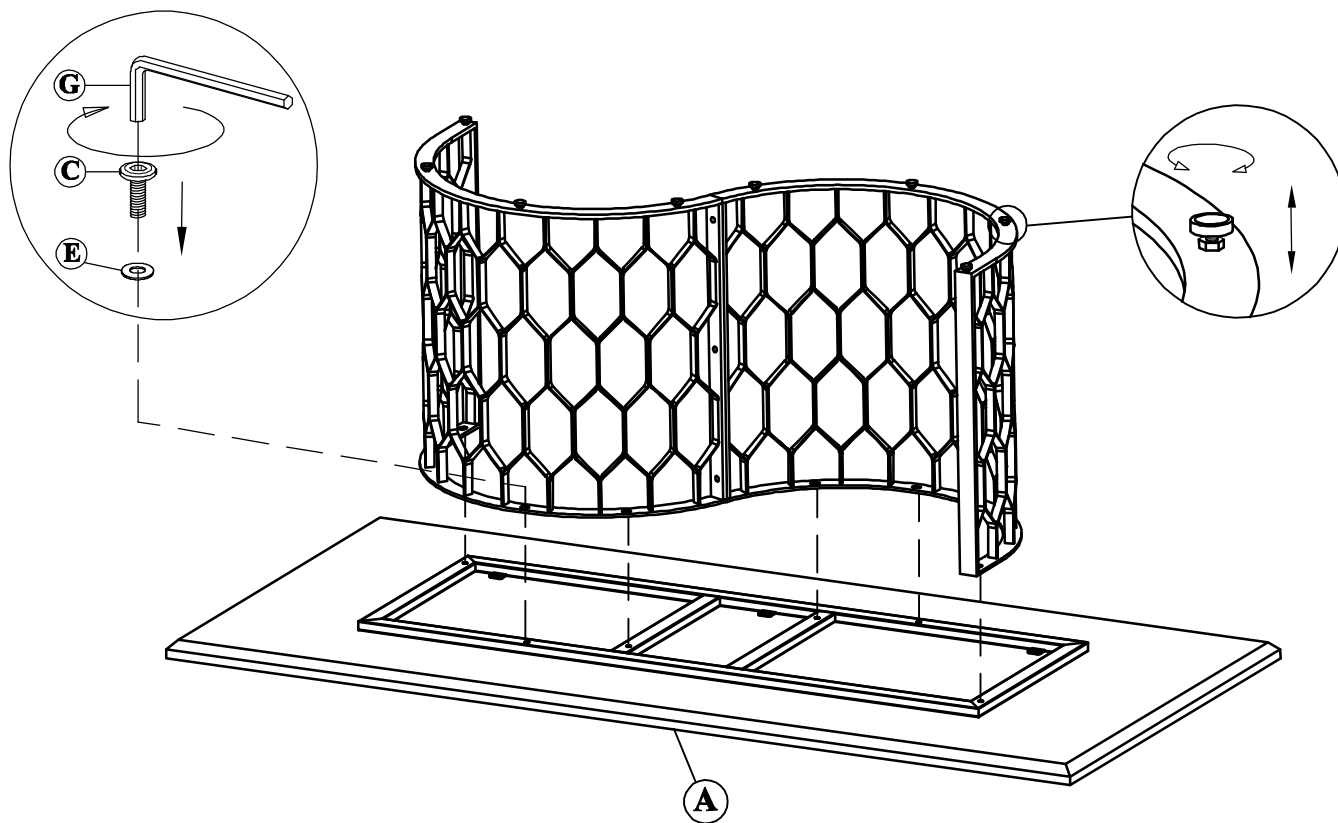

STEP 3

