

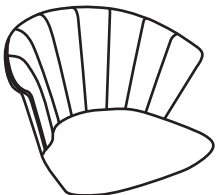





# Assmebly Instruction

<b>A*1</b>		<b>F*1+1EXT</b>	 <b>M6*30MM</b>
<b>B*1</b>		<b>G*4+1EXT</b>	 <b>M6*50MM</b>
<b>C*1</b>		<b>L*1</b>	 <b>M4</b>

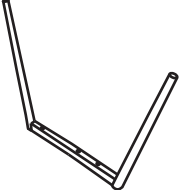
## STEP 1

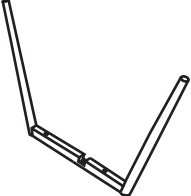

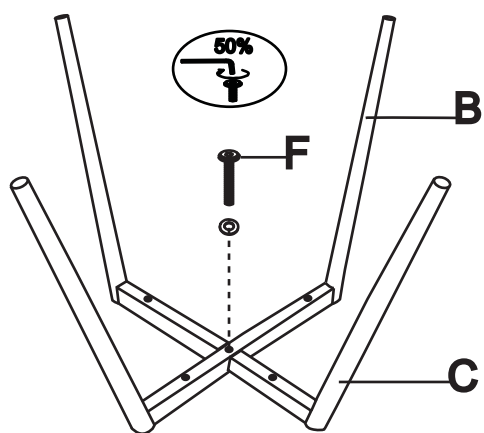
## STEP 2

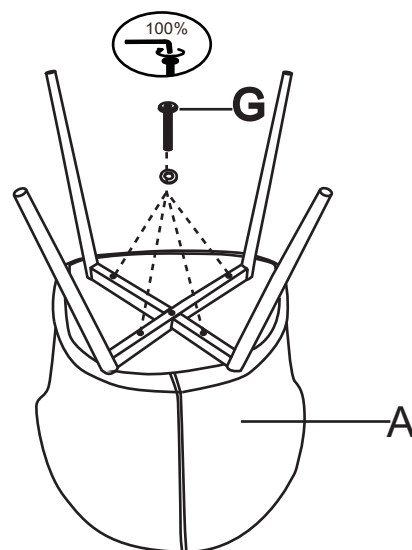

## STEP 3

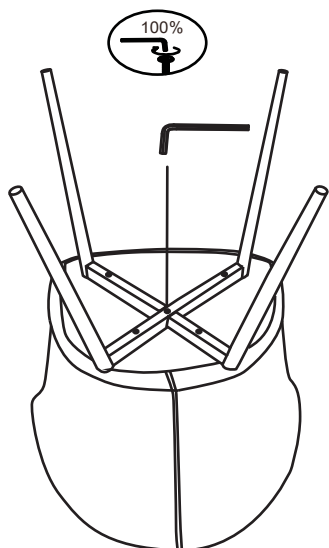

## STEP 4

