

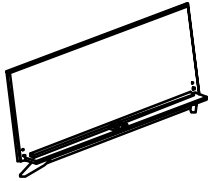









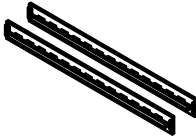
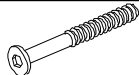
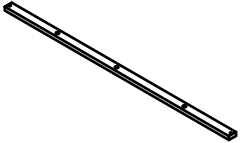

Product Assembly Instructions

LOFT-KB200

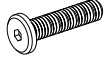
| | | | |
|--|--|---|---|
|  <p>A: Headboard x1</p> |  <p>B: Footboard x1</p> |  <p>C: Side Rall (L+R) x2</p> |  <p>G: Bolt M8*40mm x4</p> |
|  <p>D: Middle Rall x1</p> |  <p>E: Center Leg x3</p> |  <p>F: Slat Frame x 14</p> |  <p>H: Washer x4</p> |
| | | |  <p>I: Screw nut M8 x4</p> |
| | | |  <p>J: Bolt M6*10mm x4</p> |
| | | |  <p>K: Bolt M6*60mm x3</p> |
| | | |  <p>L: Screw M4*30mmx30</p> |
| | | |  <p>M: Allen key M4 x1</p> |
| | | |  <p>N: Wrench x1</p> |
| | | |  <p>O: Allen key M5 x1</p> |

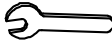
STEP 1

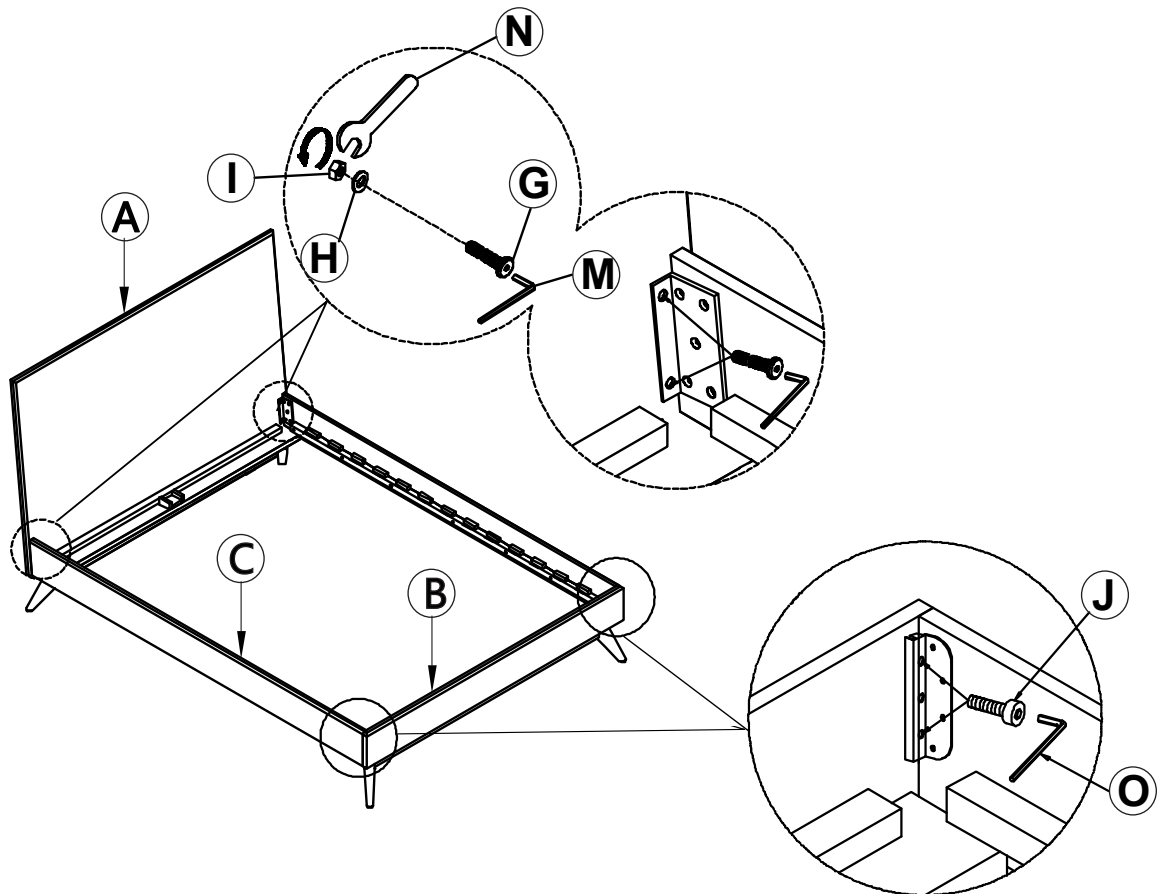

STEP 2

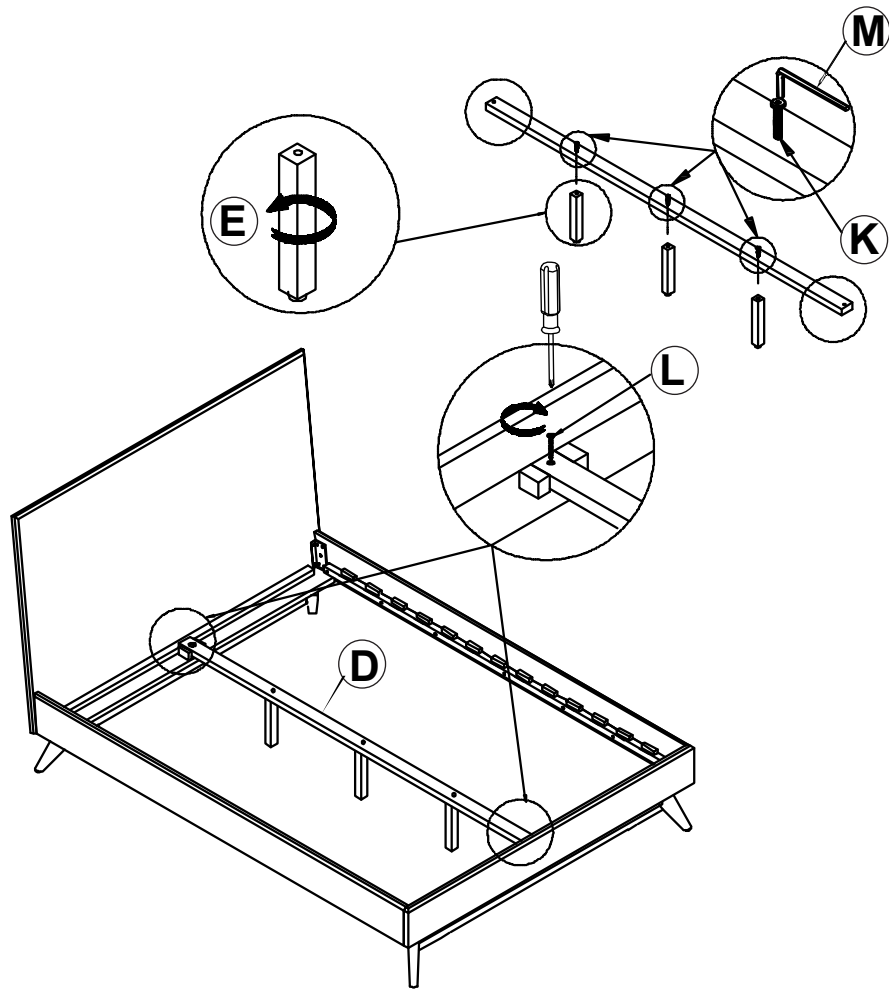

STEP 3

