

1*1

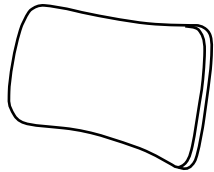

2*1

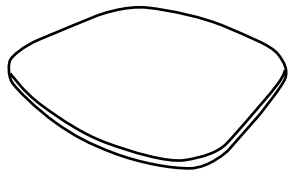

3*2



4*1

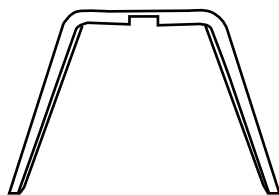

5*1

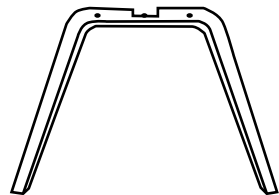

A*4



M6*20

B*4

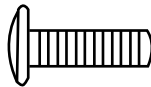

M6*30

C*1



M6*25

D*4



M6*42

E*13



M6*16*1

G*2



M6

H*4

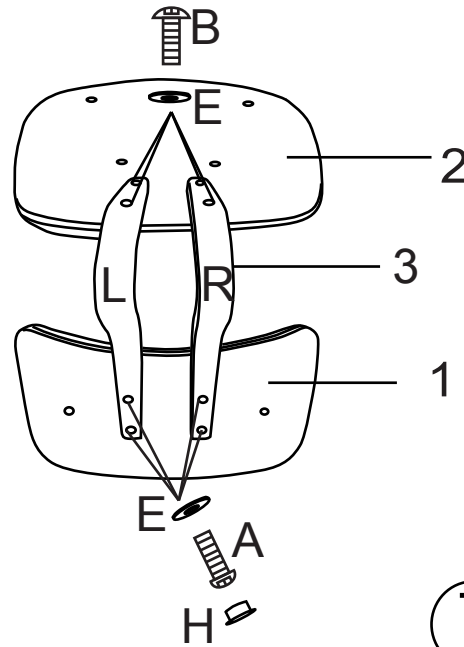

1

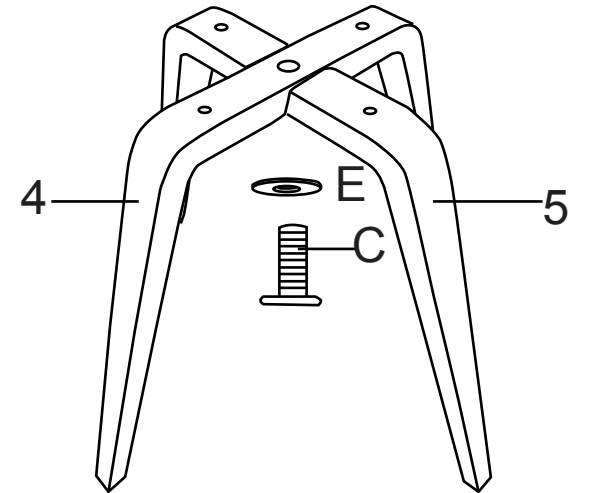

2

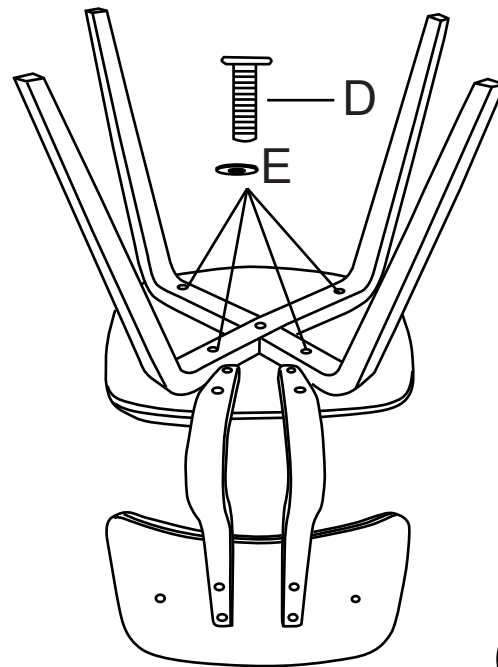

3

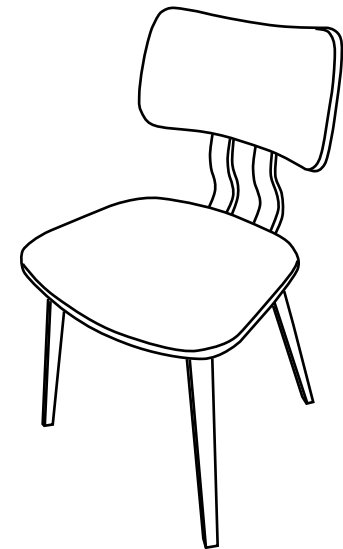

4