

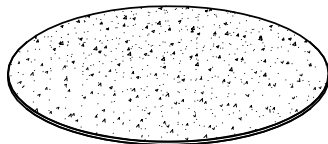



# DINING TABLE



A x 1

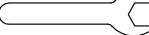

B x 4

LIST OF HARDWARE		
NO.	HARDWARE	QTY.
1	Hex nut 	08
2	S.S spring washer 	08
3	S.S washer 	08
4	Spanner 	01

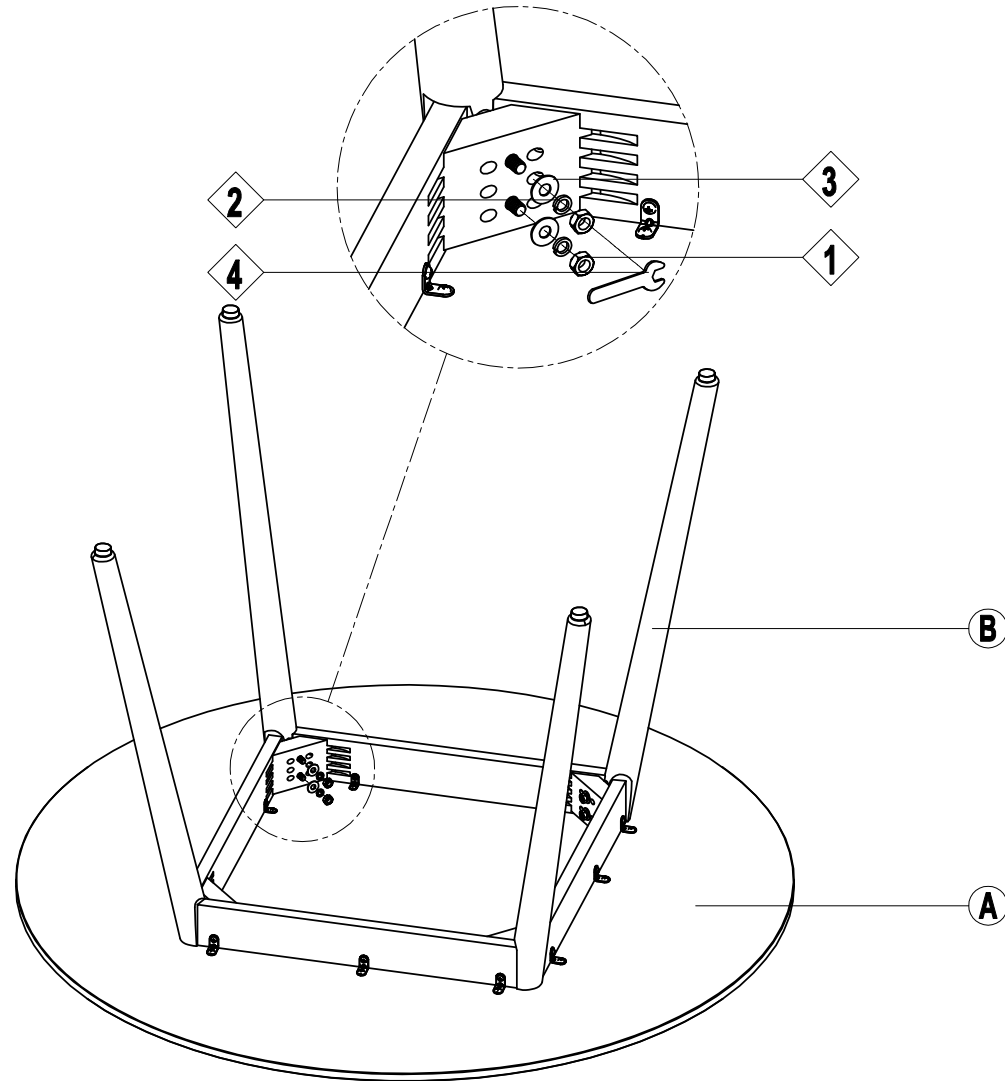

# Dining Armchair (KD)

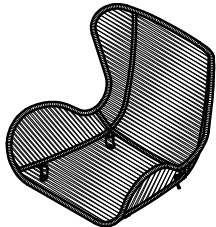
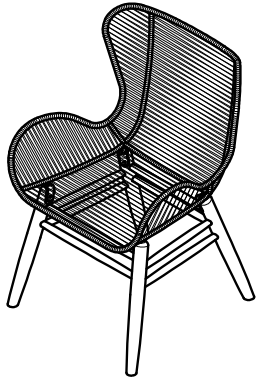

A x 1

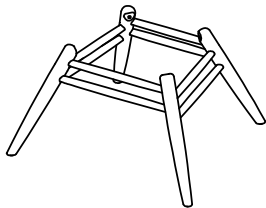

B x 1

### LIST OF HARDWARE

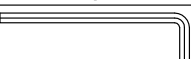
NO.	HARDWARE	QTY.
1	F-screw 	04
2	Allenkey 	01

