

**Ax1**

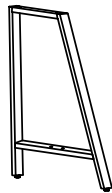



**Bx2**



**Cx2 (L&R)**

**LIST OF HARDWARE**

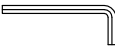
NO.	HARDWARE	QTY.
01	F-bolt M6 x 35mm 	04
02	F-bolt M6 x 15mm 	08
03	Allen Key 	01

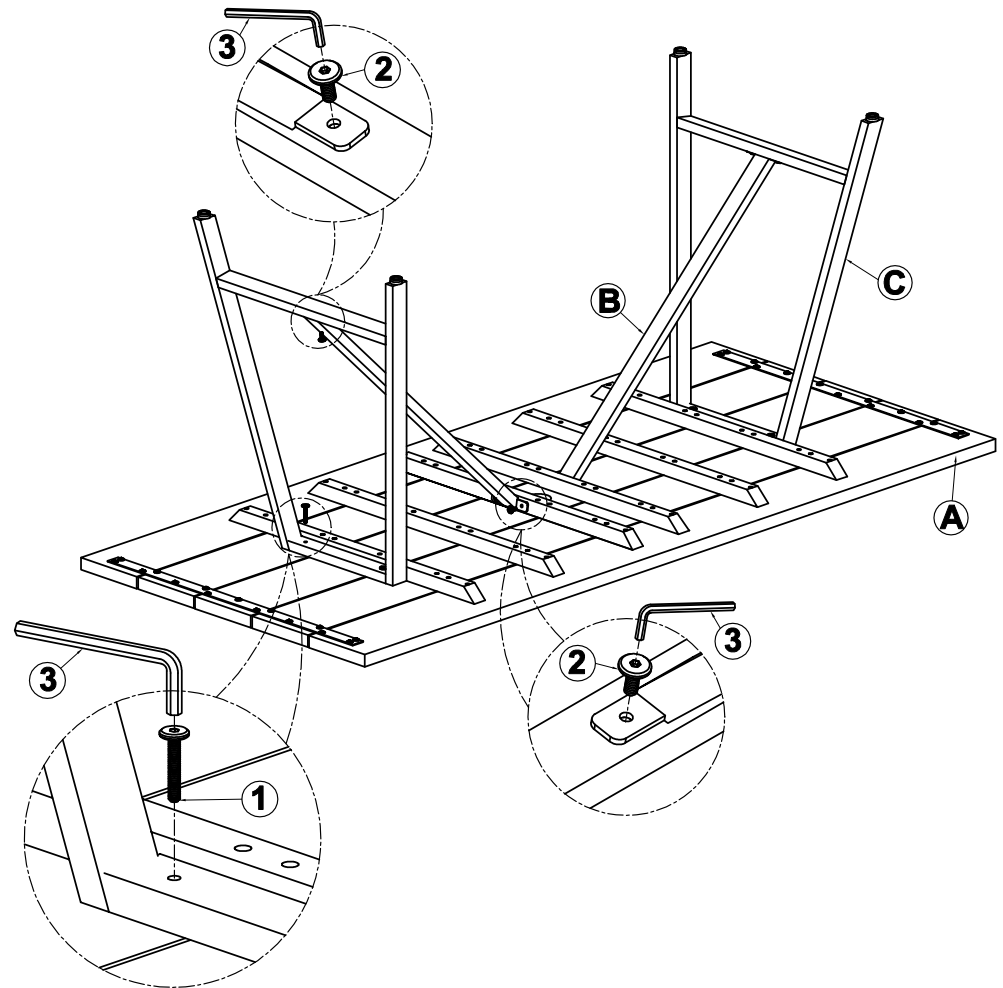

# Bench (KD)

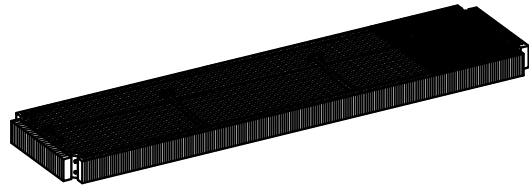
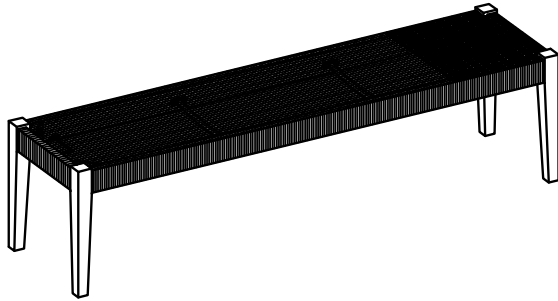



A x 1



B x 4

### LIST OF HARDWARE

NO.	HARDWARE	QTY.
1	F-bolt 	08
2	S.S washer 	08
3	Allen Key 	01

