

# Product Assembly Instructions

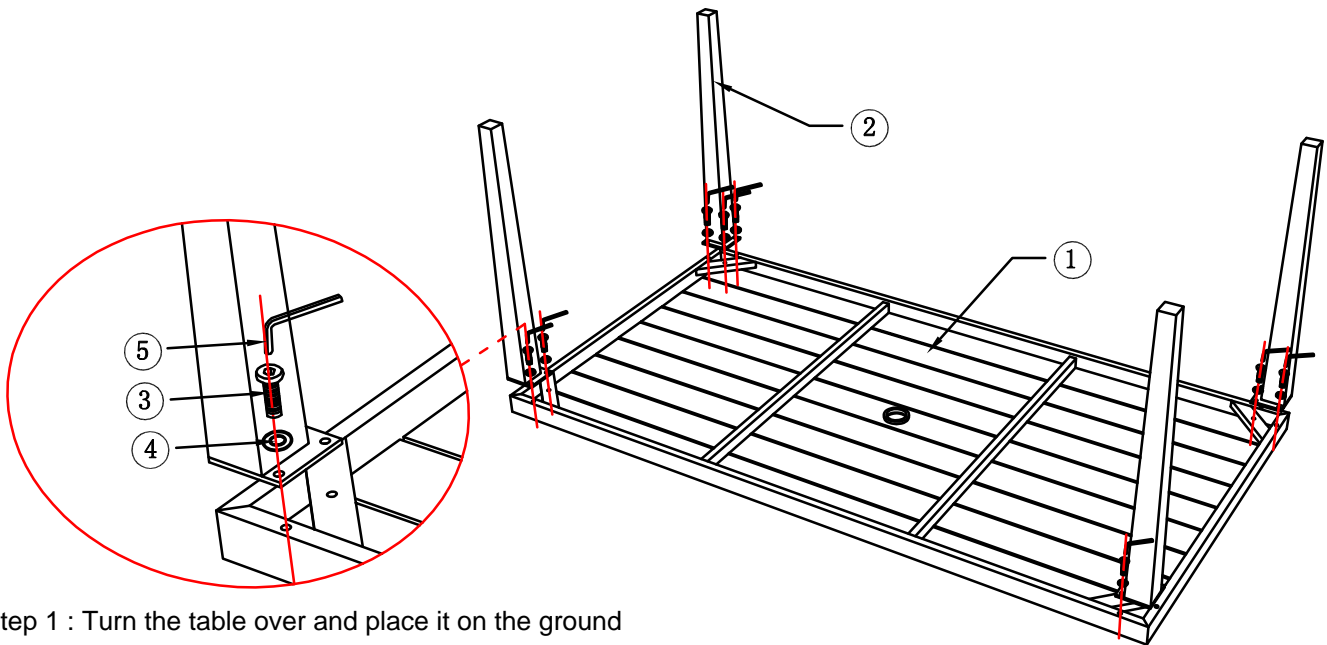
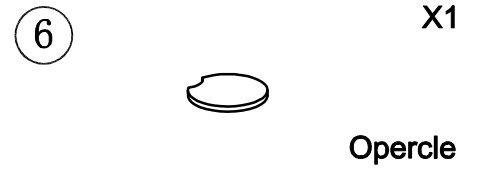
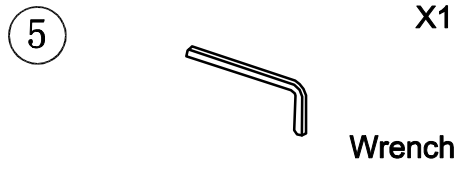
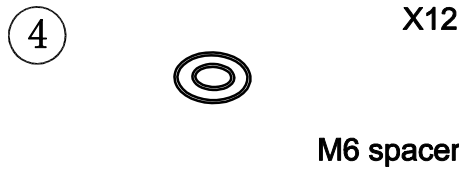
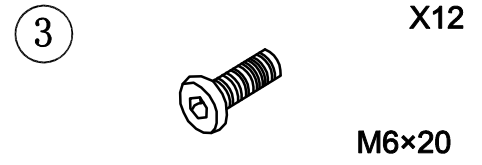
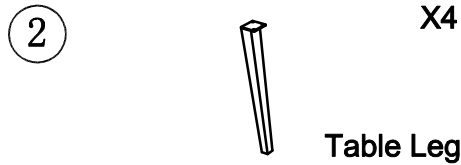
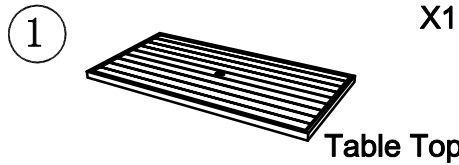

Step 1 : Turn the table over and place it on the ground where the exterior finish will not be scratched.

Step 2 : Align the screw holes of the table legs with the screw holes of the table top, insert flat washers(4) and screws(3) into each hole, once the screws are in place,tighten the screw until firmly attached with the wrench provided.

Step 3 : Repeat the above assembly procedure for the other three legs.

