

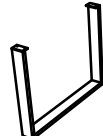



Product Assembly Instructions

 <p>① X1 Table Top</p>	 <p>② X2 Table Leg</p>	 <p>③ X1 Kickstand</p>
 <p>④ X12 M6×20</p>	 <p>⑤ X12 M6 spacer</p>	 <p>⑥ X1 Wrench</p>

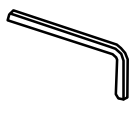
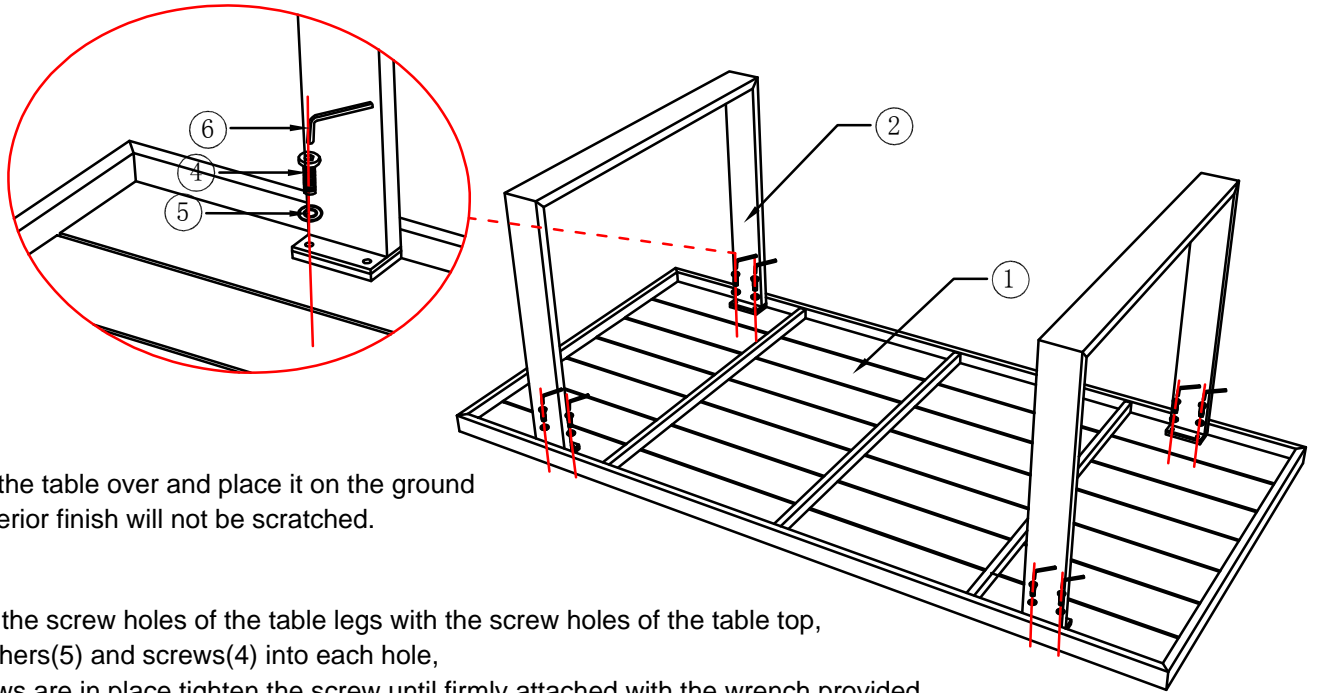

Step 1 : Turn the table over and place it on the ground where the exterior finish will not be scratched.

Step 2 : Align the screw holes of the table legs with the screw holes of the table top, insert flat washers(5) and screws(4) into each hole, once the screws are in place,tighten the screw until firmly attached with the wrench provided.

Step 3: Insert the flat washer (5) and screw (4) into each hole, and then install the Kickstand.

