







ASSEMBLY INSTRUCTIONS

MODEL : 3269-02 RAQUEL DINING CHAIR

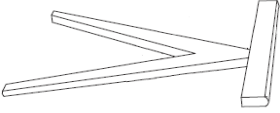
Please read instructions carefully

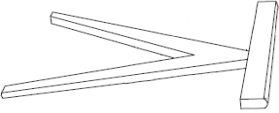
Remove all wrapping materials, staples and packing straps from the carton. Refer to Parts List and Hardware List and ensure they are complete before you start assembling. Place all wooden parts on a clean, flat and soft surface (e.g carpet or rug) to prevent parts from being scratched.

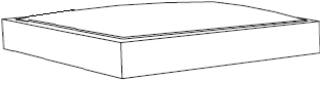
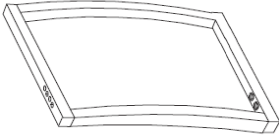
- CAUTIONS: 1) DO NOT FULLY TIGHTEN BOLTS AND NUTS UNTIL ALL PARTS HAVE BEEN ASSEMBLED.
 2) DO NOT OVER-TIGHTEN BOLTS AND NUTS .
 3) KEEP ALL HARDWARE PARTS OUT OF REACH OF CHILDREN.

Carton	Designation	Part List	Hardware List
1	LEG FRAME-RIGHT	 P1 x 2pc	 H1 x 16pc
	LEG FRAME-LEFT	 P2 x 2pc	M6x35mm JCBC SCREW
	SUPPORT RAIL	 P3 x 4pc	 H2 x 8pc
	SEAT	 P4 x 2pc	M6x50mm JCBC SCREW
	BACKREST	 P5 x 2pc	 H3 x 24pc Spring Washer

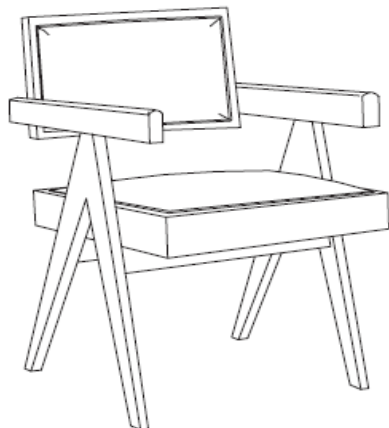

COMPLETE ASSEMBLY









ASSEMBLY INSTRUCTIONS

MODEL : 3269-02 RAQUEL DINING CHAIR

PARTS LIST (FOR 2 CHAIRS)

NO.	COMPONENT	QTY.
P1	LEG FRAME- RIGHT	2
P2	LEG FRAME- LEFT	2
P3	SUPPORT RAIL	4
P4	SEAT	2
P5	BACKREST	2

HARDWARE LIST (FOR 2 CHAIRS)

NO.	DESCRIPTION	QTY.
H1	JCBC SCREW M6 x 35MM 	16
H2	JCBC SCREW M6 x 50MM 	8
H3	SPRING WASHER 	24
H4	FLAT WASHER (BIG) 	8
H5	FLAT WASHER (SMALL) 	8
H6	WOODEN DOWEL M10 x 30mm 	16
H7	WOODEN DOWEL M8 x 30mm 	16
H8	WOOD BUTTON 	8
H9	ALLEN KEY 	1

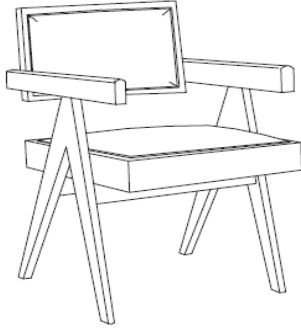

COMPLETE ASSEMBLY

RUBBER Mallet IS NOT PROVIDED.







SCREWDRIVER IS NOT PROVIDED.



STEP 1

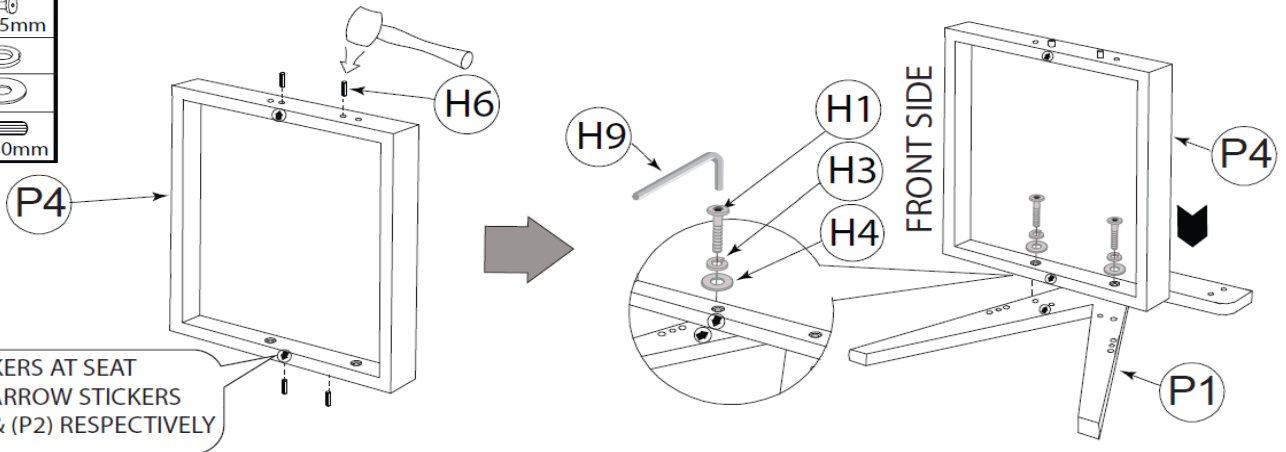

Prepare the Seat (P4) by inserting the Wooden dowel (H6) into the desired holes.

H1 x 2		M6 x 35mm
H3 x 2		
H4 x 2		
H6 x 4		M10 x 30mm



Attach the Seat (P4) to the Leg frame by locating the dowels into the desired holes in the Leg (P1). Match the ARROW stickers to ensure the seat is in the correct position. Then, align Screw (H1) with Spring washer (H3) & Flat washer Big (H4) tighten it using Allen key (H9).

STEP 2



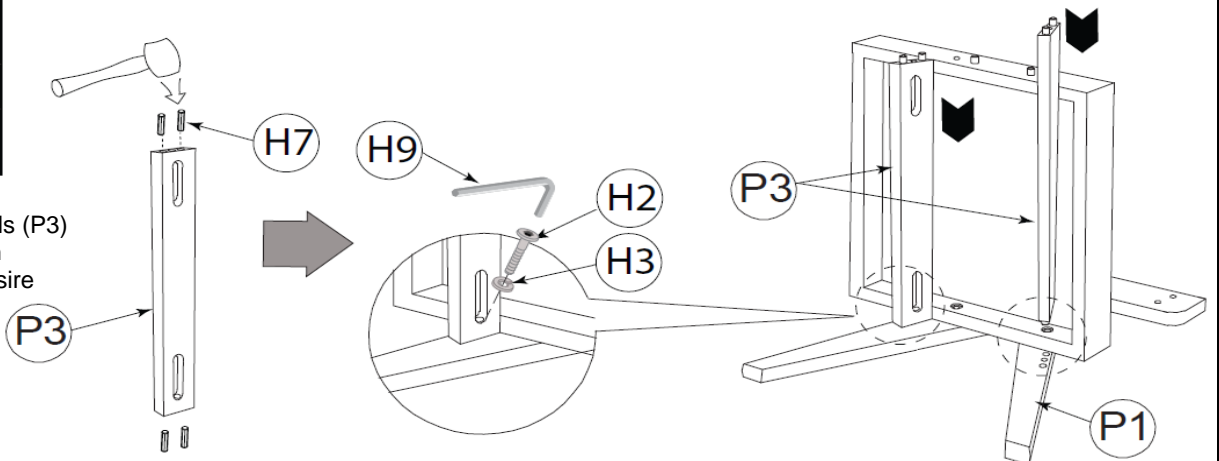

H2 x 2		M6 x 50mm
H3 x 2		
H7 x 8		M8 x 30mm

Prepare the Support rails (P3) by inserting the wooden dowels (H7) into the desired holes.



Assemble both Support rails (P3) into the desired holes in the Leg frame. Align Bolt (H2) with Spring Washer (H3) & tighten it using Allen key (H9).

STEP 3

H1 x 2	 M6 x 35mm
H3 x 2	
H5 x 2	
H6 x 4	 M10 x 30mm
H8 x 2	

Prepare the Backrest (P5) by inserting the Wood dowel (H6) into the desired holes at the backrest. Then, attach the Backrest (P5) by locating the wood dowel at the backrest into the desired holes at the armrest. Align Bolt (H1) together with the Spring washer (H3) & Flat washer Small (H5). Tighten it using Allen key (H9).

Tap the Wood button (H8) to cover the holes.

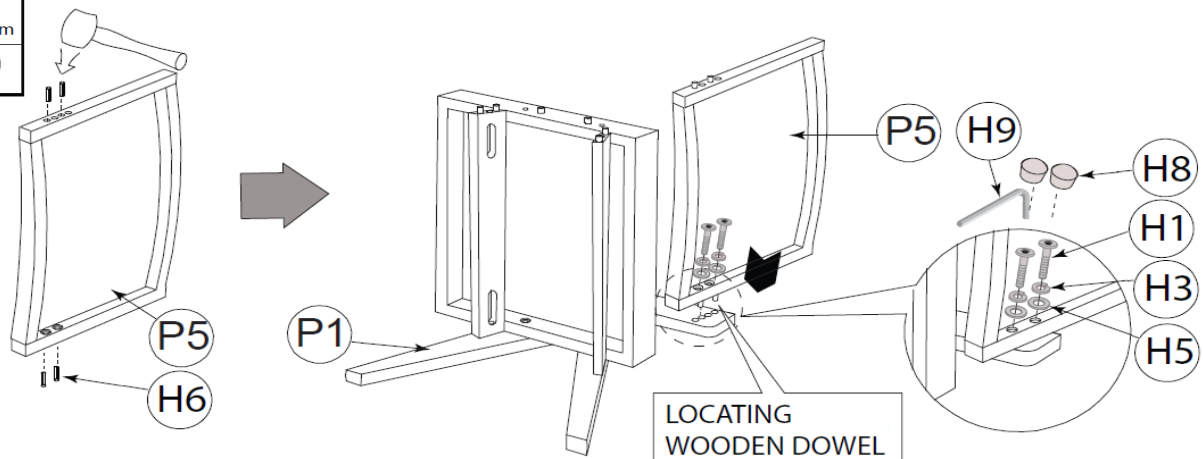

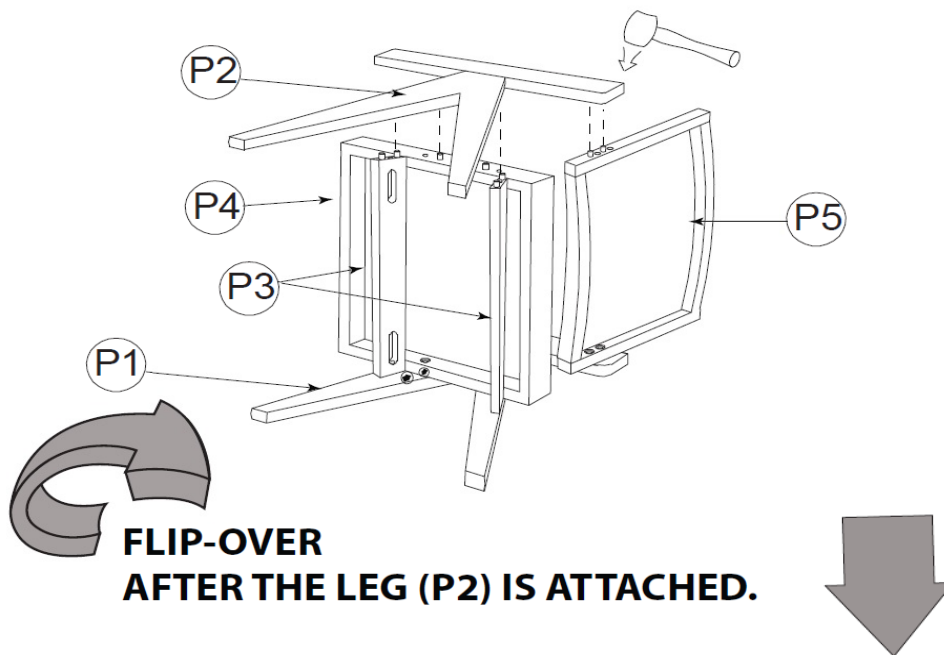

STEP 4

Prepare the other side of the leg: the Leg frame-Left (P2). Attach it to the parts of (Seat P4), Support rail (P3) & Backrest (P5), by locating the wood dowel at those parts to the desired holes in the Leg (P2). Use a rubber mallet to tap the leg frame until all the parts are snug to the leg frame. Then, carefully flip the chair to the other side to secure remaining holes with corresponding bolts.



STEP 5



H1 x 2	 M6 x 35mm
H3 x 2	
H4 x 2	

FITTING TO THE SEAT

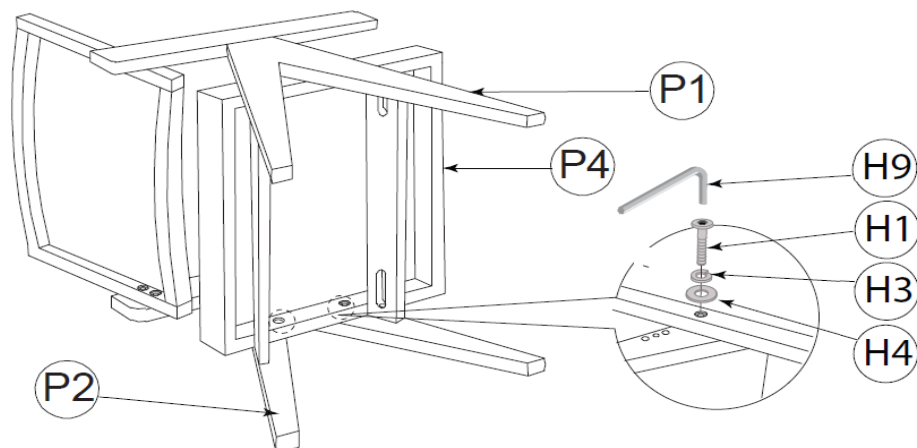
Start with fitting the leg to the seat by aligning Screw (H1) with Spring washer (H3) & Flat washer Big (H4). Tighten it using Allen key (H9).



STEP 6



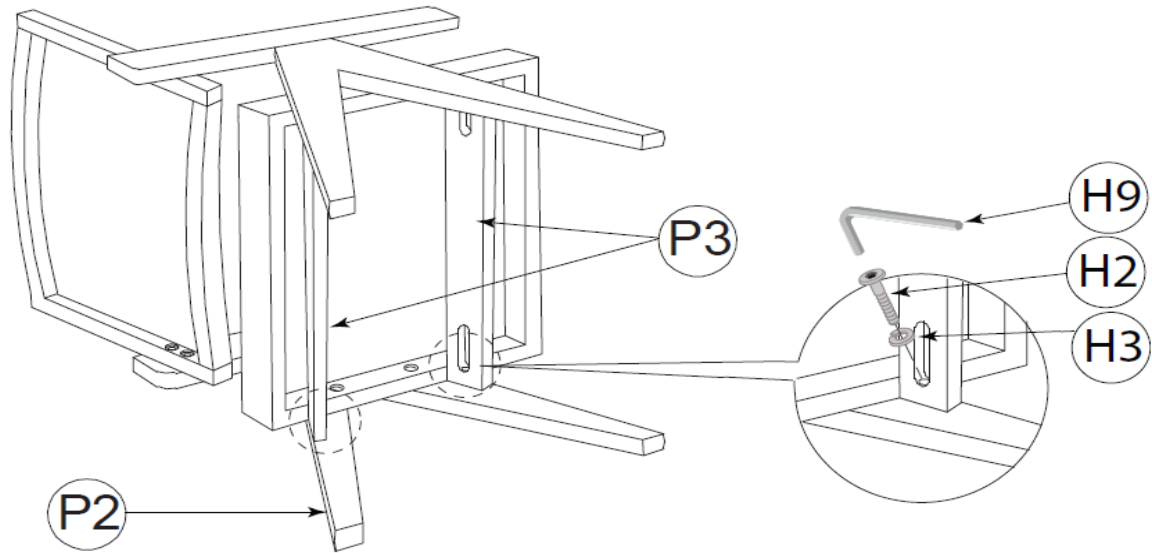

H2 x 2	
M6 x 50mm	
H3 x 2	

FITTING TO THE SUPPORT RAILS

Continue with fitting to the Support rails (P3), by Aligning Bolt (H2) with Spring Washer (H3) & tighten it using Allen key (H9).



STEP 7

H1 x 2	
M6 x 35mm	
H3 x 2	
H5 x 2	
H8 x 2	

FITTING TO THE BACKREST

Lastly, fit the armrest to the backrest by Aligning Bolt (H1) together with the Spring washer (H3) & Flat washer Small (H5). Tighten it using Allen Key (H9). Tap the Wood button (H8) to cover the holes.

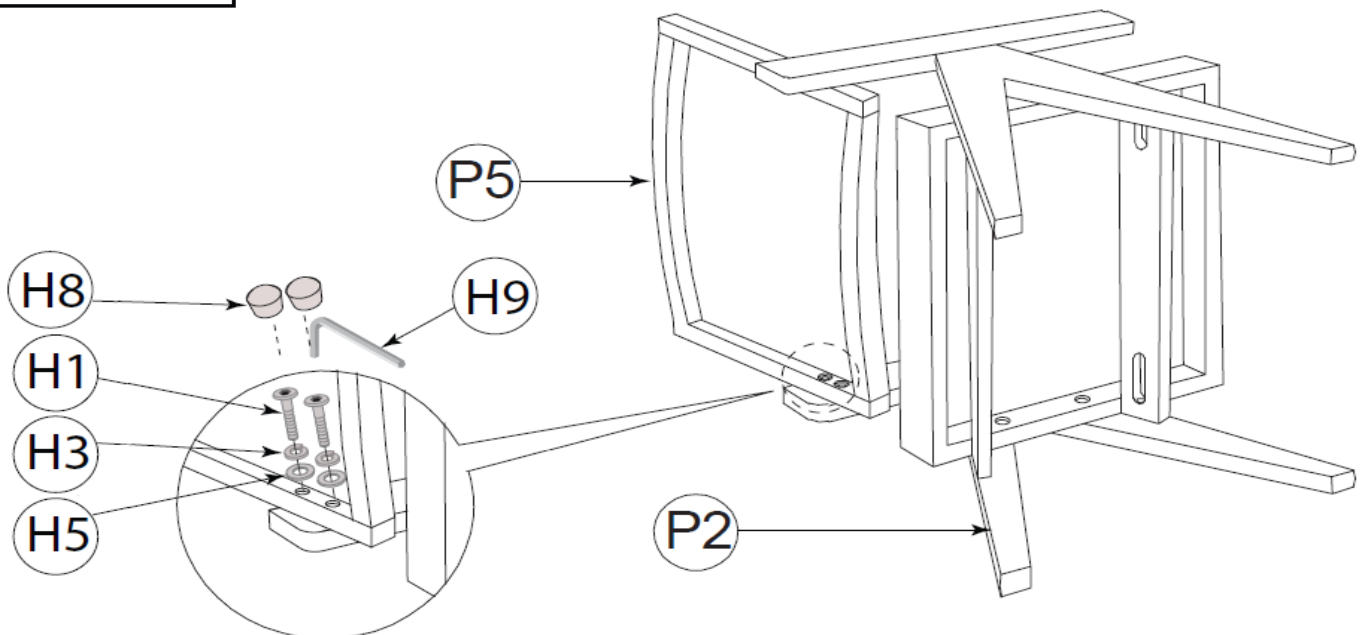

PLEASE MAKE SURE ALL THE BOLTS ARE FULLY TIGHTEN BEFORE USING THE CHAIR

CARE AND MAINTENANCE

SAFETY - To avoid any risk of suffocation to children or animals, dispose off the plastic bags immediately.

CLEANING - Clean with damp cloth and mild detergent. Do not use bleach or abrasive products.

FITTINGS - Tighten bolts and nuts from time to time to ensure all parts of product are securely fitted.