

## ASSEMBLY INSTRUCTIONS

Before assembling your Daybed, please read through these instructions carefully. Familiarize yourself with the different parts.

**ATTENTION!** If you receive a damaged or defective item, please contact afifurnishings at customerservice@afifurnishings.com or 1-800-955-3726

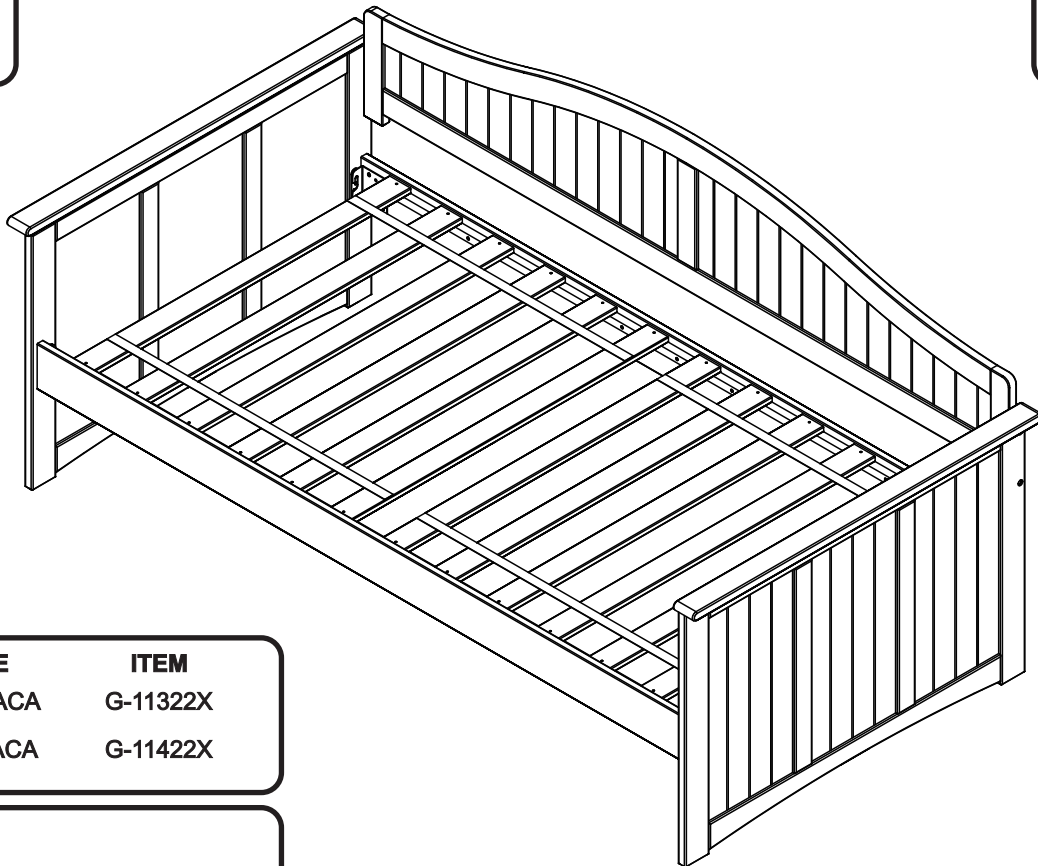
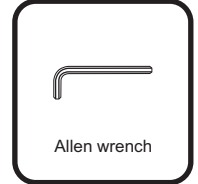

CODE	ITEM
DB-AM-ACA	G-11322X
DB-FP-ACA	G-11422X

**PO :**

## HARDWARE

NOTE: WE INCLUDE SPARE HARDWARE IN CASE DAMAGE OCCURS DURING ASSEMBLY.

**A**  Wood dowel - 4 pcs  
Spare - 1 pc

**D**  Wood Screw - 24 pcs  
Spare - 1 pc

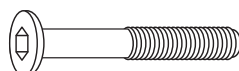
**B**  JCB M6 X 2 1/2" ( 65mm ) - 4 pcs  
Spare - 1 pc

**F**  Allen wrench M6 - 1 pc

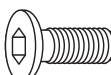
**C**  JCB M8 X 5/8" ( 15mm ) - 8 pcs

**E**  Barrel Nut - 4 pcs  
Spare - 1 pc

**G**  Allen wrench M4 - 1 pc

# PARTS LIST

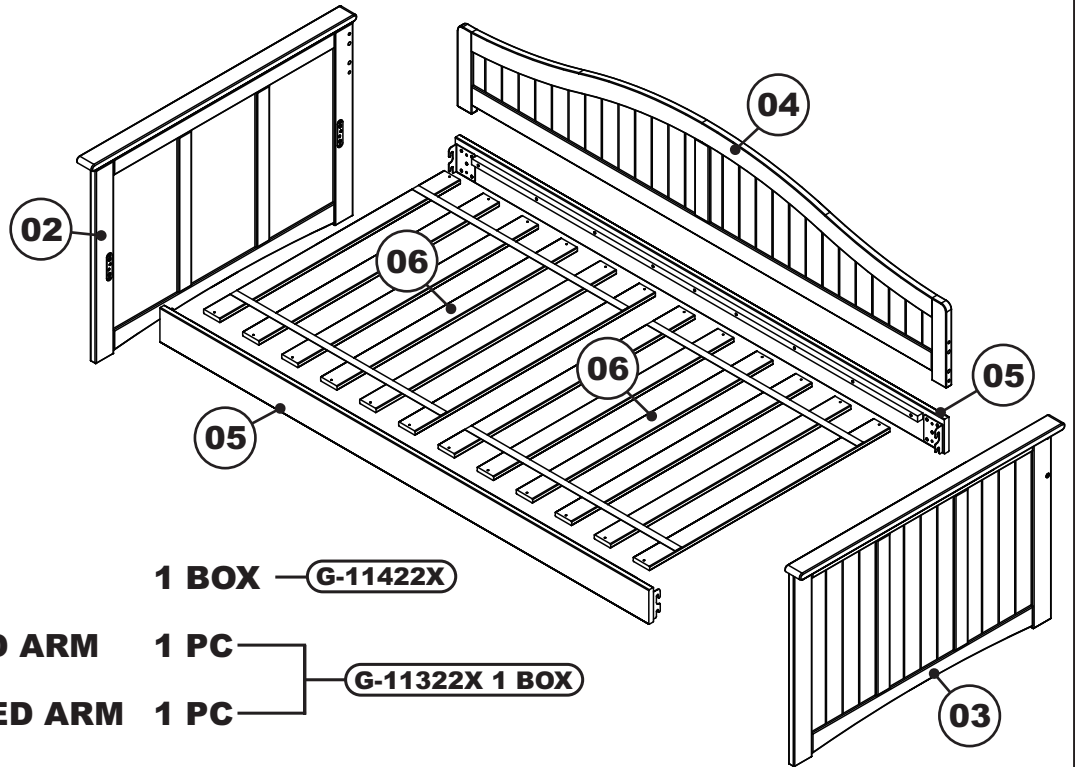

- |           |                          |              |                       |
|-----------|--------------------------|--------------|-----------------------|
| <b>01</b> | <b>HARDWARE</b>          | <b>1 BOX</b> | <b>G-11422X</b>       |
| <b>02</b> | <b>LEFT DAYBED ARM</b>   | <b>1 PC</b>  | <b>G-11322X 1 BOX</b> |
| <b>03</b> | <b>RIGHT DAYBED ARM</b>  | <b>1 PC</b>  |                       |
| <b>04</b> | <b>BACK PANEL</b>        | <b>1 PC</b>  | <b>G-11422X 1 BOX</b> |
| <b>05</b> | <b>FRONT / BACK RAIL</b> | <b>2 PCS</b> |                       |
| <b>06</b> | <b>SLAT KIT</b>          | <b>2 SET</b> |                       |



## Step 1

Attach the back panel (04) to the left and right daybed arm (02)(03), using wood dowels (A), JCB M6 X 2 1/2" (B) and barrel nut (E). Tighten with the Allen wrench (G).

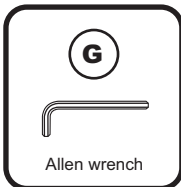
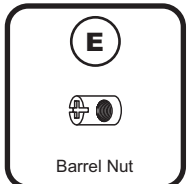
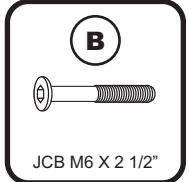
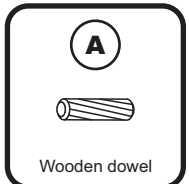
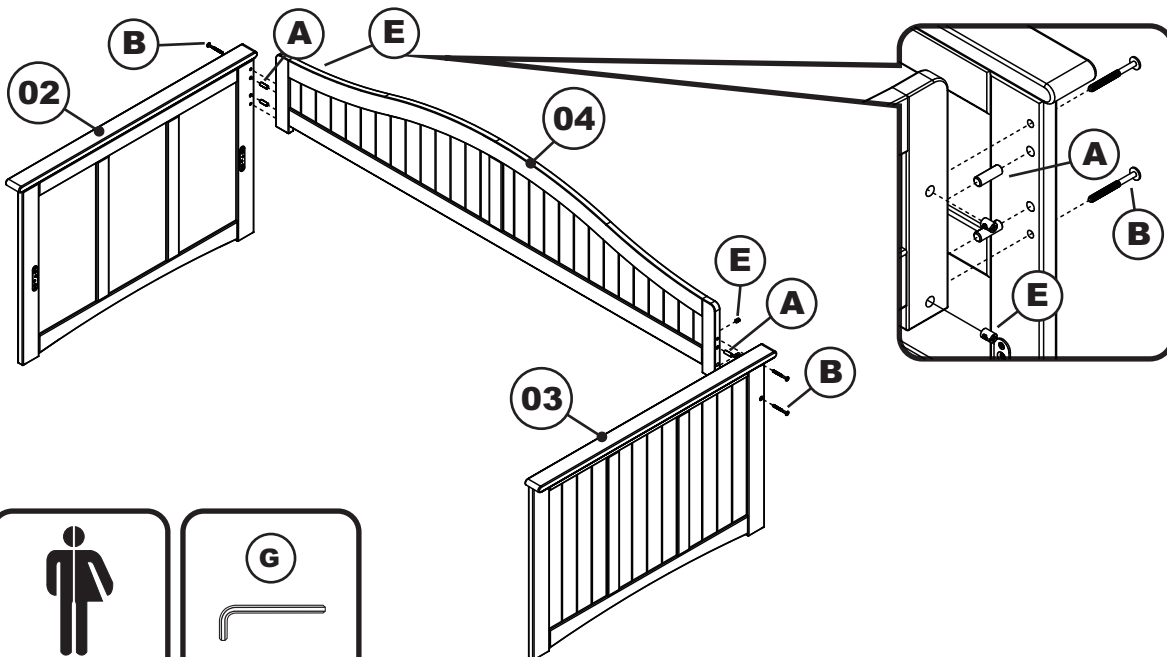

## Step 2

Attach the front and back rail (05) to the Daybed arms as shown, using JCB M8 X 5/8" (C). Tighten with the Allen wrench (F).

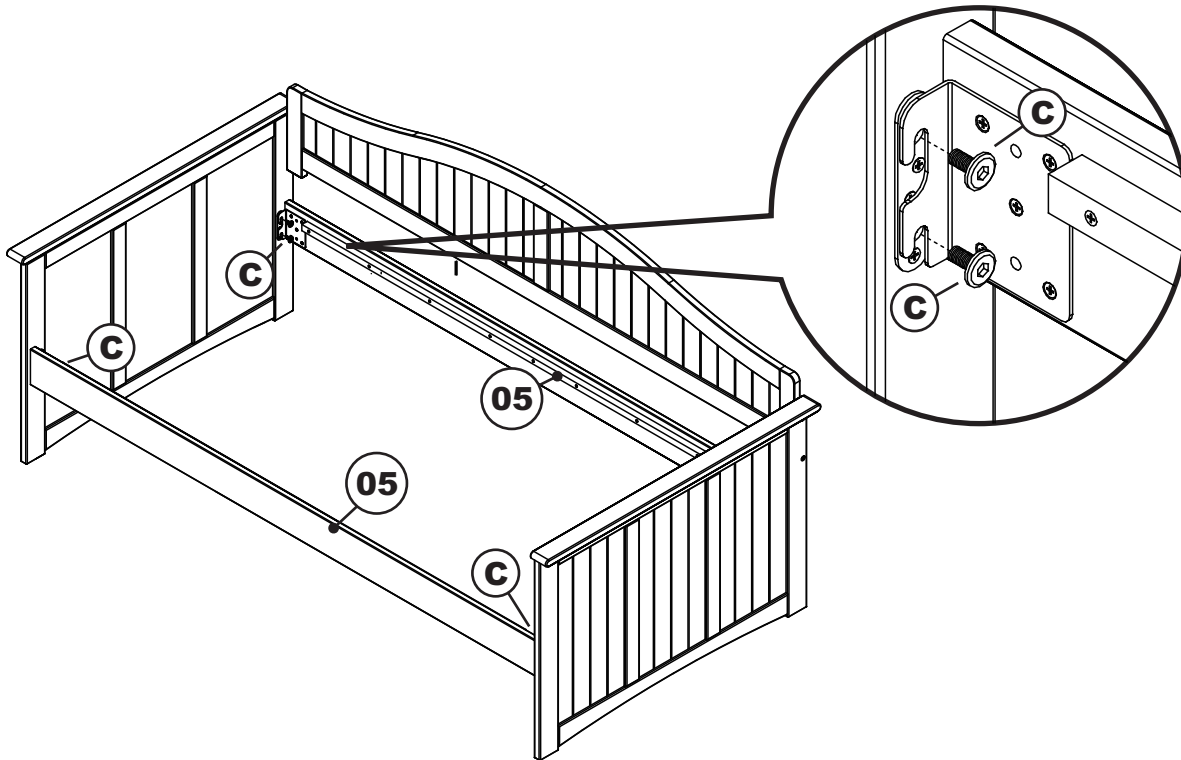

Adult assembly

C



JCB M8 X 5/8"

F



Allen wrench

## Step 3

Lay the slat kit (06) onto the rail assembly as shown, using wood screw (D). Tighten with the Phillips head screw driver (Customer supplied).

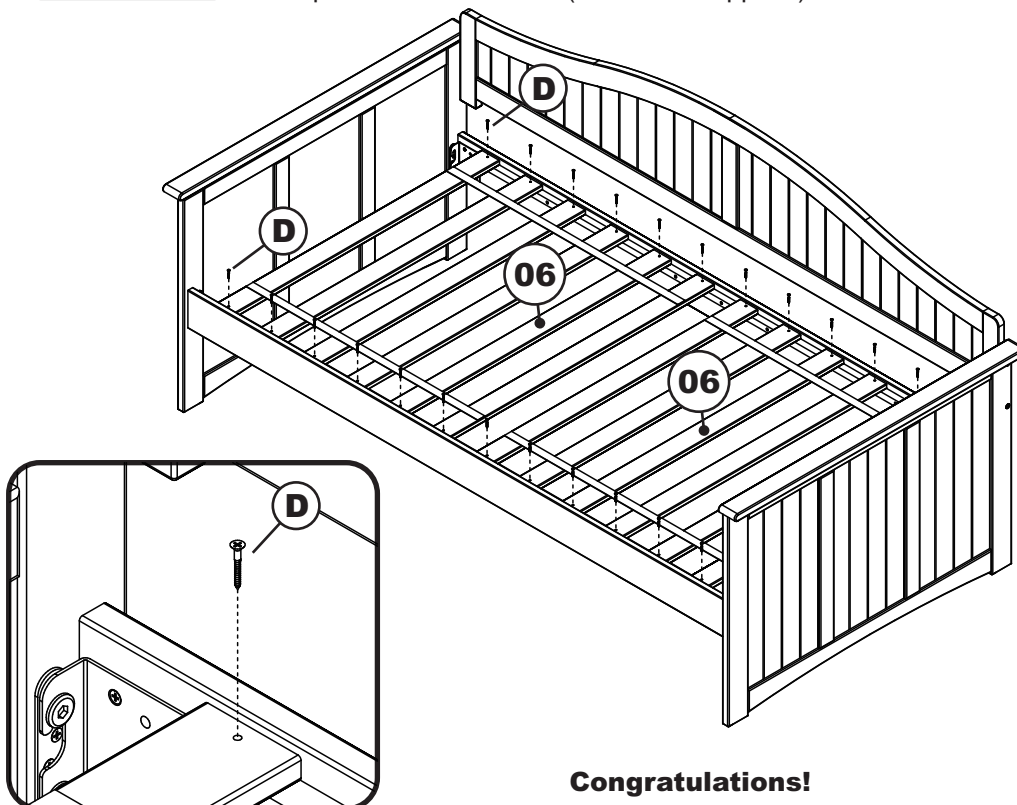

Adult assembly

D



Wood screw

Phillips screwdriver



Customer supplied

### Congratulations!

Your Daybed is now ready for use.

We recommend that you periodically check that all screws are tight and all parts are secure to ensure lasting safety.