

ASSEMBLY INSTRUCTIONS

Before assembling your Daybed, please read through these instructions carefully. Familiarize yourself with the different parts.

ATTENTION! If you receive a damaged or defective item, please contact afifurnishings at customerservice@afifurnishings.com or 1-800-955-3726

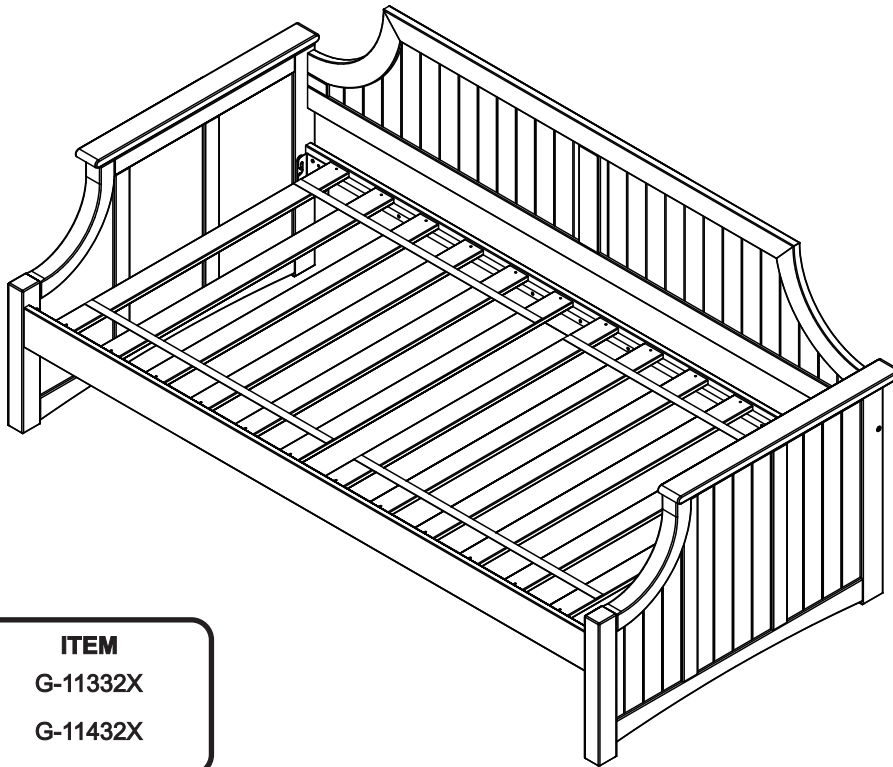
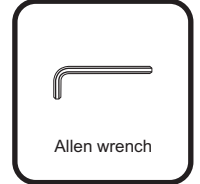

CODE	ITEM
DB-AM-CBG	G-11332X
DB-FP-CBG	G-11432X

PO :

HARDWARE

NOTE: WE INCLUDE SPARE HARDWARE IN CASE DAMAGE OCCURS DURING ASSEMBLY.

A  Wood dowel - 4 pcs
Spare - 1 pc

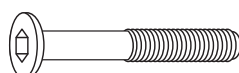
B  JCB M6 X 2 1/2" (65mm) - 4 pcs
Spare - 1 pc

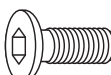
C  JCB M8 X 5/8" (15mm) - 8 pcs

D  Wood Screw - 24 pcs
Spare - 1 pc

E  Barrel Nut - 4 pcs
Spare - 1 pc

F  Allen wrench M6 - 1 pc

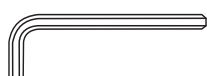
G  Allen wrench M4 - 1 pc

PARTS LIST

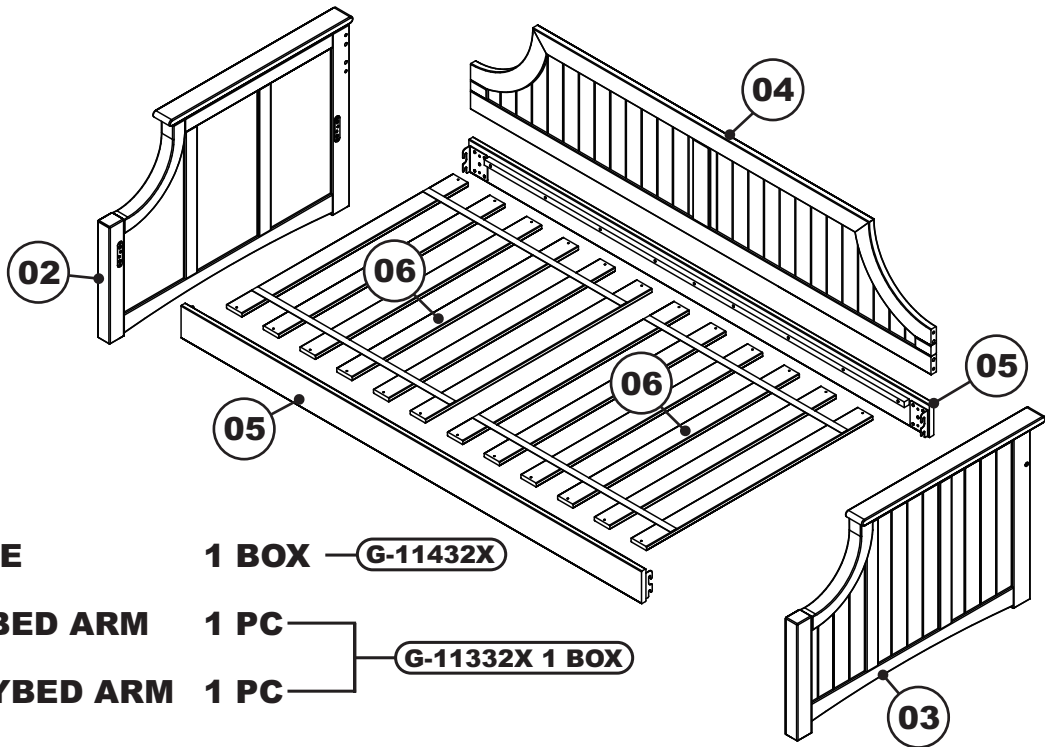

- | | | | |
|-----------|--------------------------|--------------|-----------------------|
| 01 | HARDWARE | 1 BOX | G-11432X |
| 02 | LEFT DAYBED ARM | 1 PC | G-11332X 1 BOX |
| 03 | RIGHT DAYBED ARM | 1 PC | |
| 04 | BACK PANEL | 1 PC | G-11432X 1 BOX |
| 05 | FRONT / BACK RAIL | 2 PCS | |
| 06 | SLAT KIT | 2 SET | |

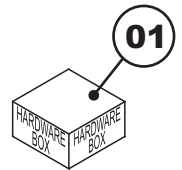

Step 1

Attach the back panel (04) to the left and right daybed arm (02)(03), using wood dowels (A), JCB M6 X 2 1/2"(B) and barrel nut (E). Tighten with the Allen wrench (G).

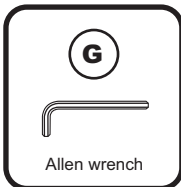
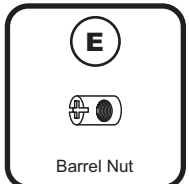
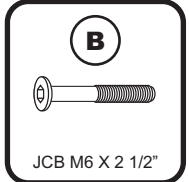
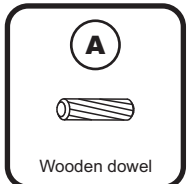
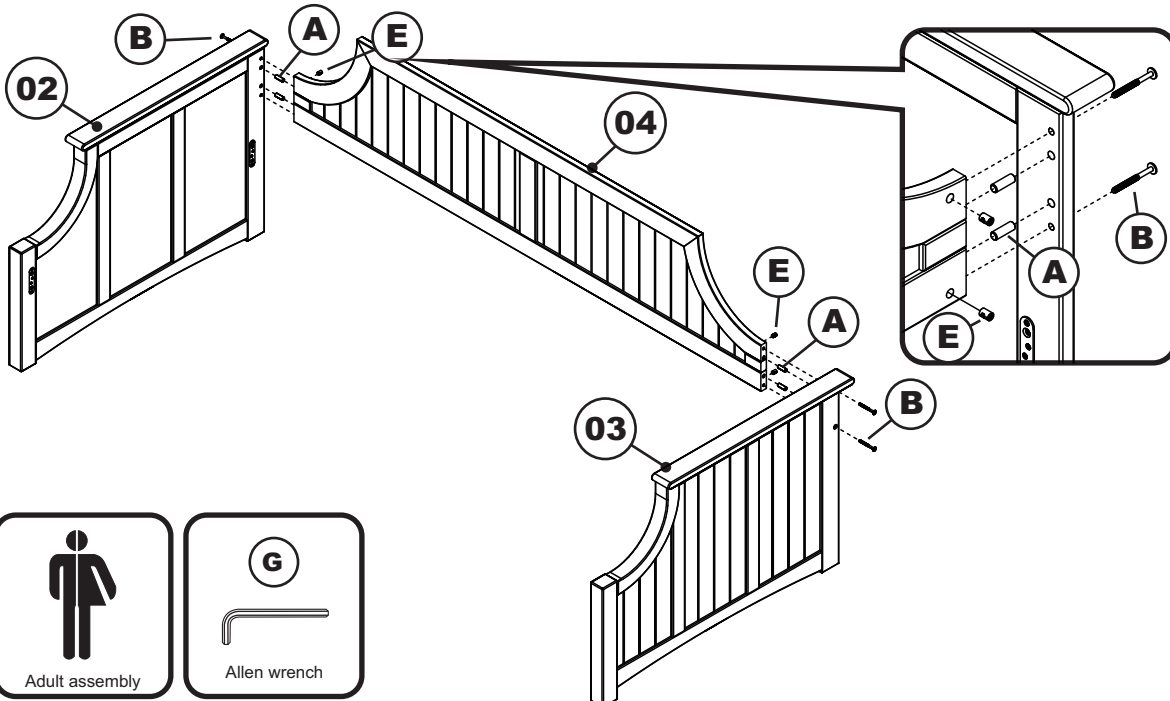

Step 2

Attach the front and back rail (05) to the Daybed arms as shown, using JCB M8 X 5/8" (C). Tighten with the Allen wrench (F).

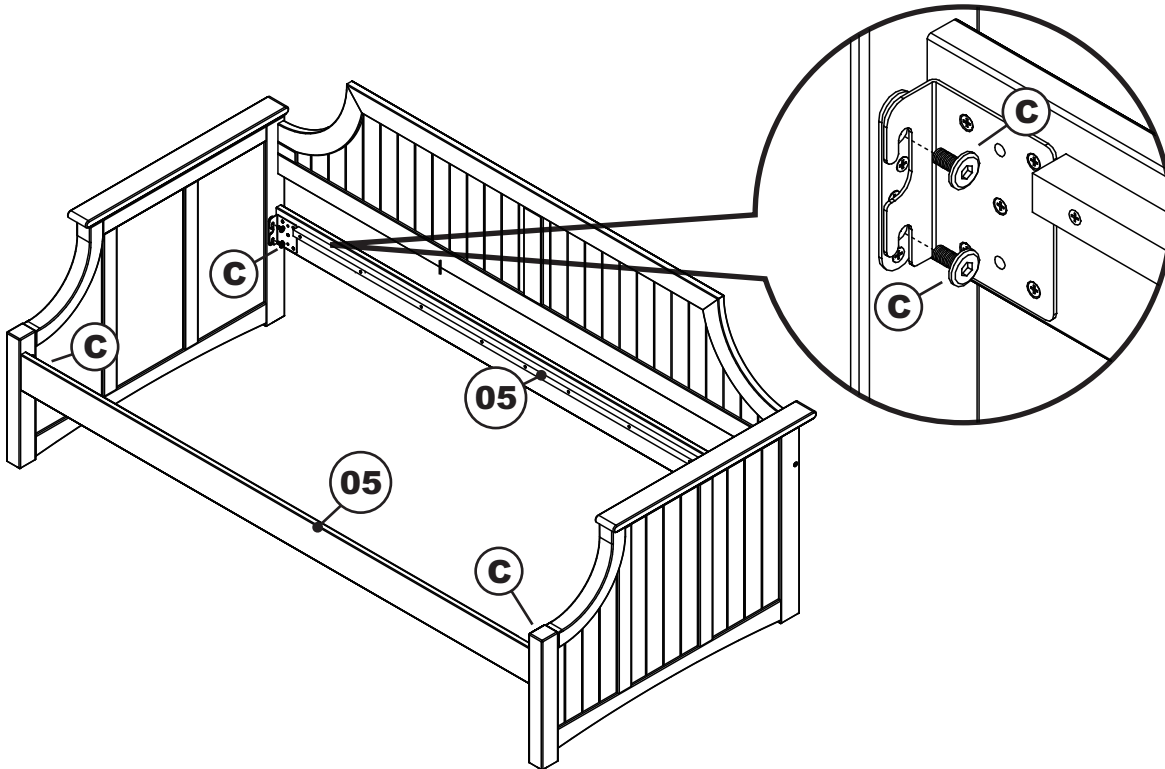

Adult assembly

C



JCB M8 X 5/8"

F



Allen wrench

Step 3

Lay the slat kit (06) onto the rail assembly as shown, using wood screw (D). Tighten with the Phillips head screw driver (Customer supplied).

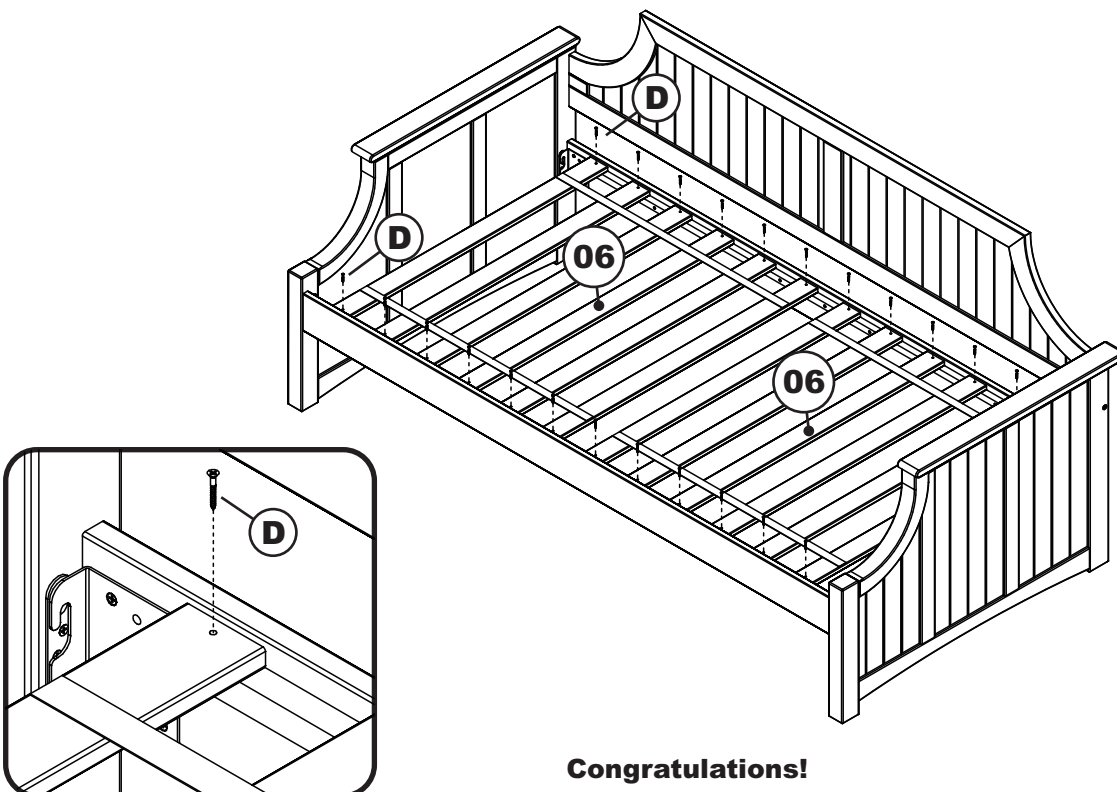

Adult assembly

D



Wood screw

Phillips screwdriver



Customer supplied

Congratulations!

Your Daybed is now ready for use.

We recommend that you periodically check that all screws are tight and all parts are secure to ensure lasting safety.