

ASSEMBLY INSTRUCTION

59378

ROCKING CHAIR

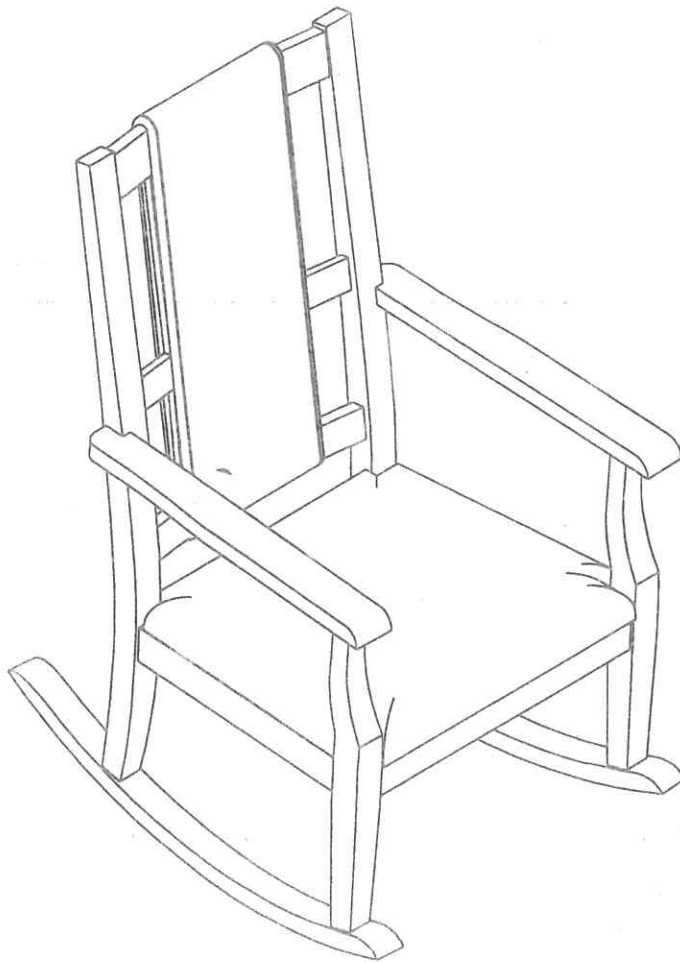

ASSEMBLY INSTRUCTION

















ASSEMBLY TIPS :

- 1 . Remove hardware from box and sort by size .
- 2 . Please check to see that all hardware and parts are present prior start of assembly .
- 3 . Please follow attached instructions in the same sequense as numbered to assure fast & easy assembly .



Warning !

- 1 . Don't attempt to repair or modify parts that are broken or defective . Please contact the store immediately .
- 2 . This product is for home use only and not intended for commercial establishment .

HARDWARE LIST				PARTS IDENTIFICATION			
1	Ø 5/16" x 75mm		4PCS	A	CHAIR BACK		1PC
2	Ø 5/16" x 50mm		4PCS				
3	Ø 5/16" x 38mm		2PCS				
4	Ø 1/4" x 50mm		4PCS	B	ARM REST (LEFT&RIGHT)		2PCS
5	Ø5/16" x 13mm		10PCS				
6	Ø5/16" x 19mm		10PCS	C	CHAIR SEAT		1PC
7	Ø1/4" x 10.5mm		4PCS				
8	Ø 1/4" x 12mm		4PCS				
9	M4 x 38mm		2PCS	D	LEG		2PCS
10	M4		1PC				
11	M3X15mm		4PCS	E	FRONT LEG (LEFT&RIGHT)		2PCS
12	25x25x2mm		2PCS				

ITEM : 59378

ASSEMBLY INSTRUCTION

STEP 1

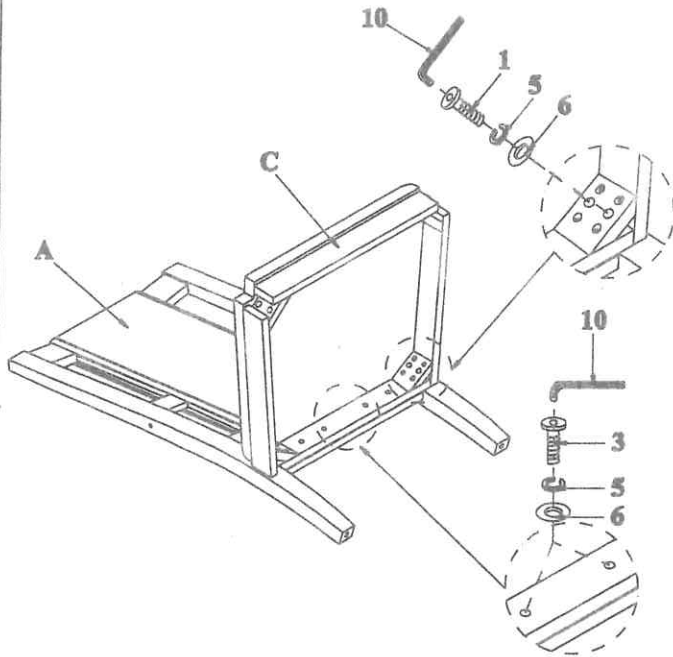

STEP 2

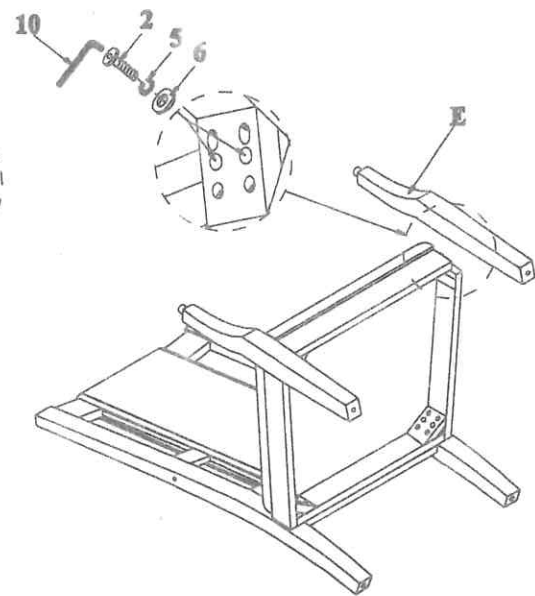

STEP 3

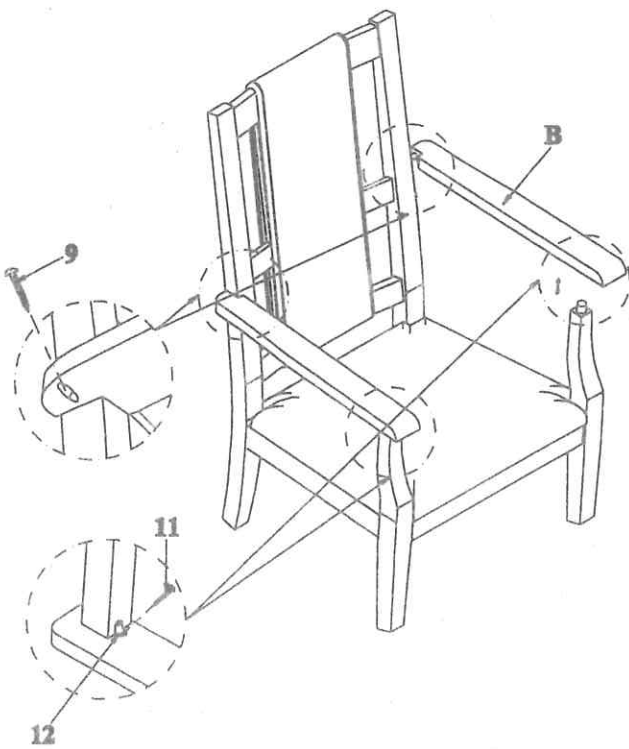

STEP 4

