

59215

YOUTH ROCKING CHAIR

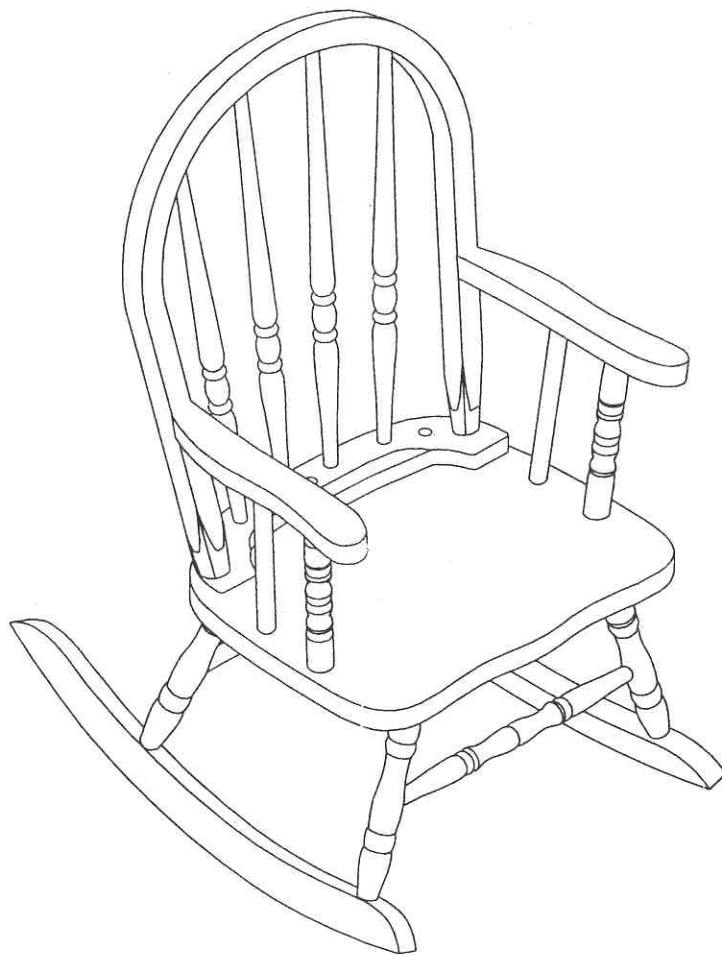

ASSEMBLY INSTRUCTION











ASSEMBLY TIPS :

- 1 . Remove hardware from box and sort by size .
- 2 . Please check to see that all hardware and parts are present prior start of assembly .
- 3 . Please follow attached instructions in the same sequense as numbered to assure fast & easy assembly .

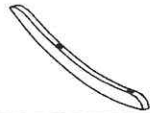

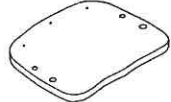
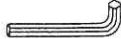
Warning !

- 1 . Don't attempt to repair or modify parts that are broken or defective . Please contact the store immediately .
- 2 . This product is for home use only and not intended for commercial establishment .

HARDWARE LIST				PARTS IDENTIFICATION			
1	Ø 3/16" x32mm		9PCS	A	CHAIR BACK		1PCS
2	Ø 3/16" x50mm		2PCS		B	ARM REST (LEFT&RIGHT)	
3	Ø 3/16" x63mm		4PCS	C		LEG (LEFT&RIGHT)	
4	Ø 3/16" x10mm		6PCS		D	CHAIR SEAT	
5	M3		1PC	E		FRONT STRETCHER	
6	Ø 10.5mm x7mm		5PCS		F	BACK STRETCHER	

STEP 2

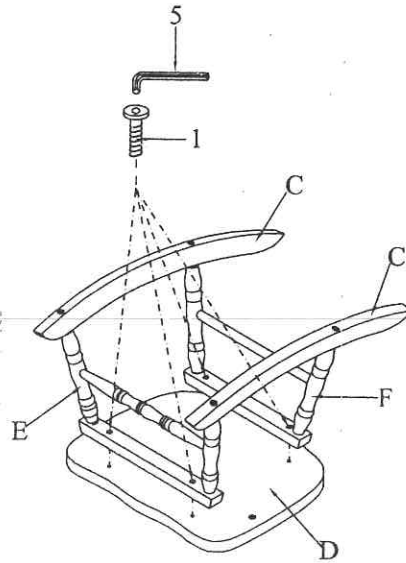
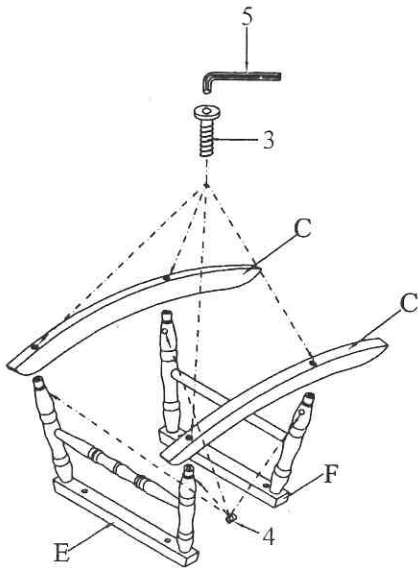

STEP 3

STEP 4

