



# ASSEMBLY INSTRUCTION

MODEL : 27945 & 27944



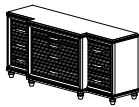

DESCRIPTION : DRESSER & MIRROR

Thank you for purchasing this quality product. Be sure to check all packing material carefully for small parts which may have loose inside the carton during shipment. Identify and count all parts and compare with the parts list below.

## BOX OF MIRROR

NO	NAME	PART	QTY
A	Dresser		1pc
B	Mirror		1pc
C	Mirror Support		2pcs

## HARDWARE LIST

NO	NAME	PART	QTY
1	Allen key		1pc
2	JCBC 35mm		8pcs
3	M6 Spring washer		8pcs
4	1/4" Flat washer		8pcs
5	AC/DC Adapter		1pc

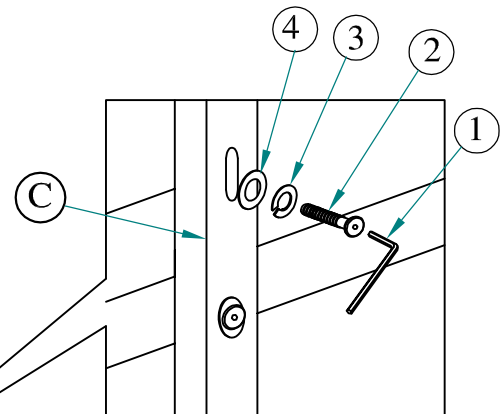
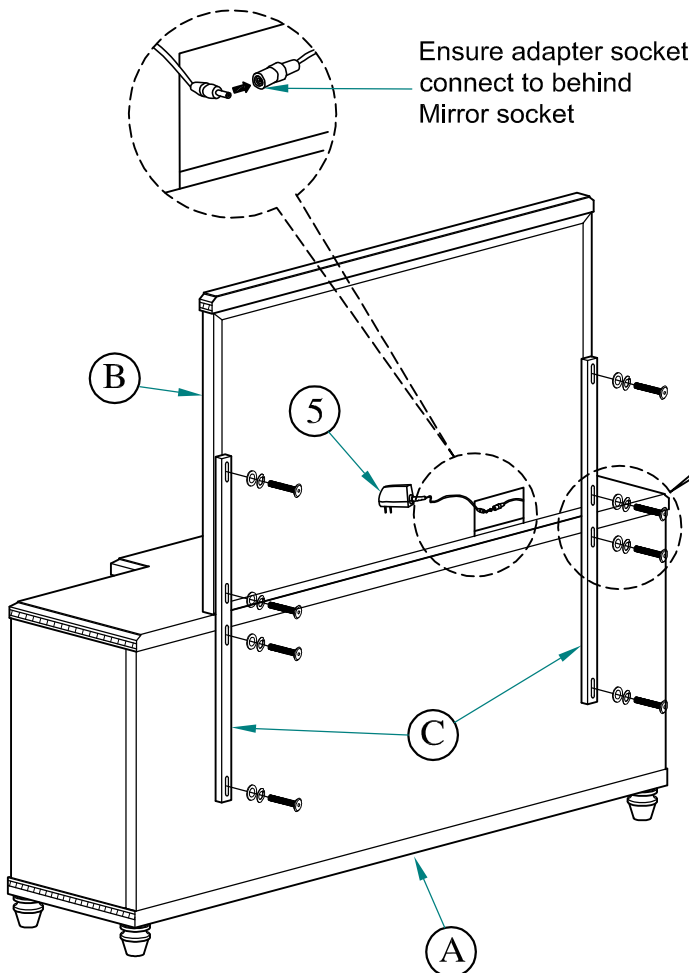

Step 1: Place (B) Mirror on the top of (A) Dresser as diagram shown. Align Mirror to the center of Dresser and tighten with (2) JCBC 35mm, (3) M6 Spring Washer & (4) 1/4" Flat Washer.

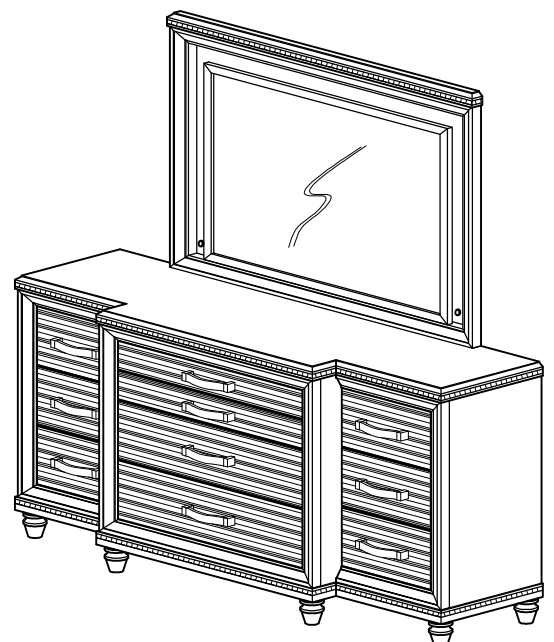

Assembly completed.