

# ASSEMBLY INSTRUCTION

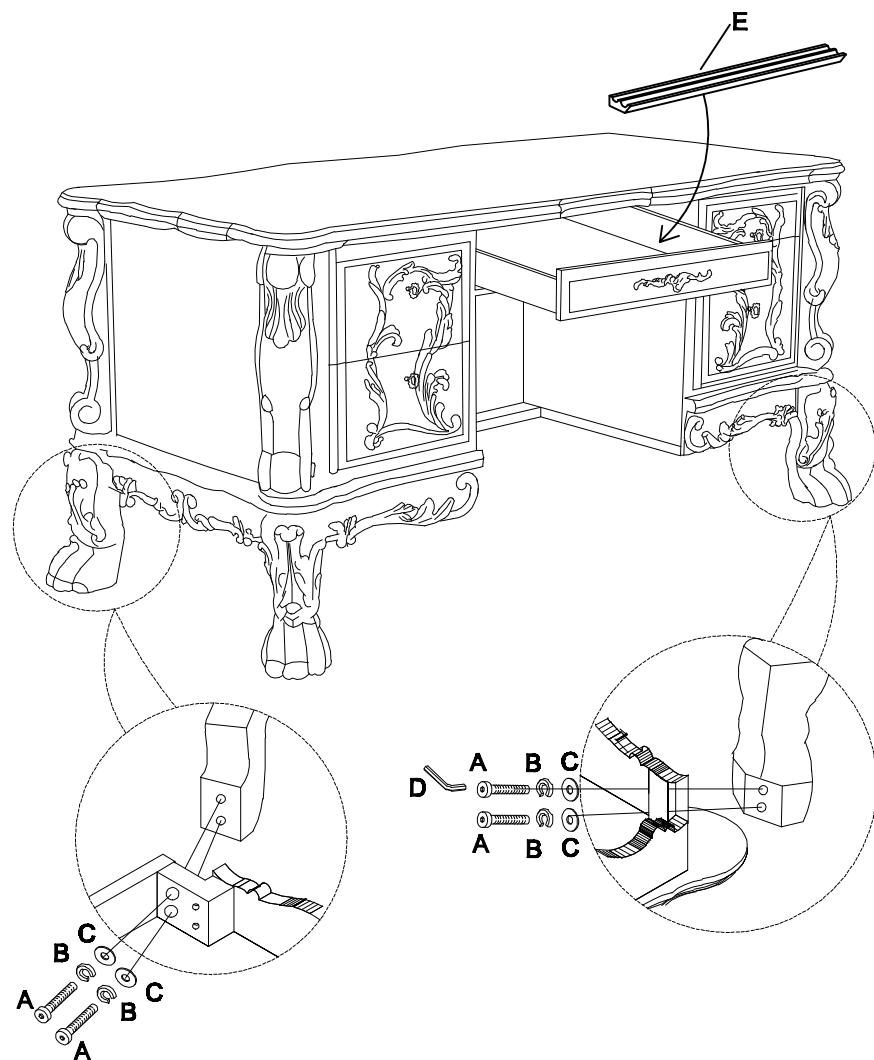

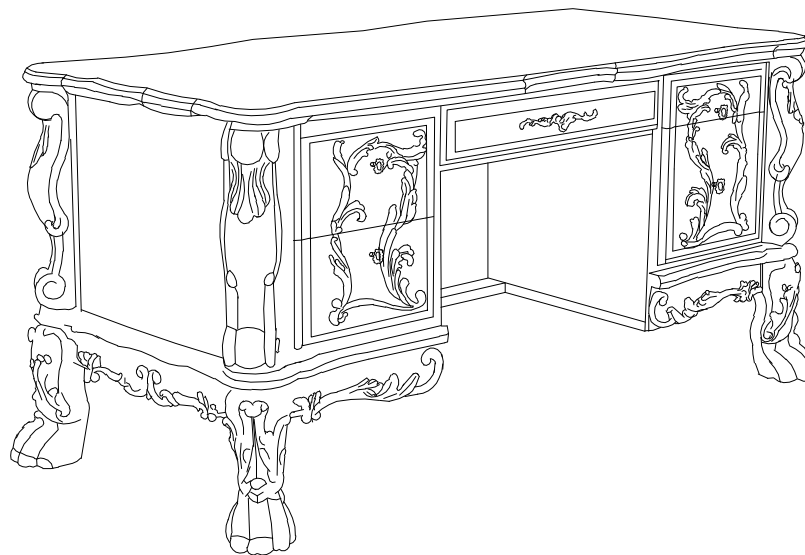

Step 1:



Finish :



## Hardware List

No.:	Description	Drawing	Size	Q' ty
A	Bolt		Ø5/16"X2"	8
B	Lock Washer		Ø5/16"	8
C	Flat Washer		Ø5/16"X19mm	8
D	Allen Wrench		5mm	1
E	Pencil Case		599*70*20mm	1