

ASSEMBLY INSTRUCTION

5114-Q

PART LIST

① HEAD BOARD

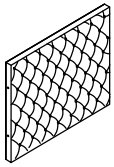

1PC

② FOOTBOARD

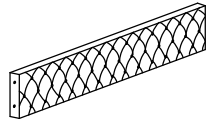

1PC

③ SIDE RAIL

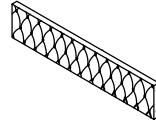

2PCS

④ HB POST (L+R)

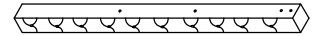

2PCS

⑤ FB POST (L+R)

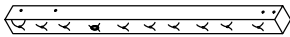

2PCS

⑥ LONG CANOPY

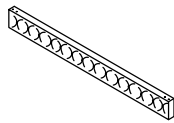

2PCS

⑦ SHORT CANOPY

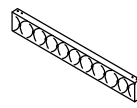

2PCS

⑧ SLAT

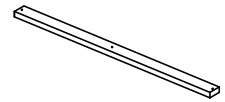

4PCS

⑨ SUPPORT LEG

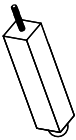

4PCS

⑩ FEET



10PCS

HARDWARE LIST

Ⓐ SCREW M4X38MM



8PCS

Ⓑ THREADED STUD
Ø5/16" X 3-1/8"

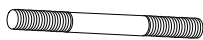

32PCS

Ⓒ FLAT WASHER
Ø5/16" X 22MM



32PCS

Ⓓ LOCK WASHER
Ø5/16"



32PCS

Ⓔ HEX NUT
Ø5/16" X 12MM







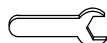

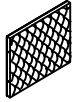

32PCS

Ⓕ WRENCH 12MM

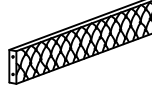
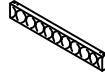
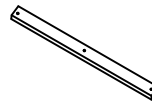

1PC

5114-Q is packed in 3 cases

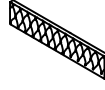
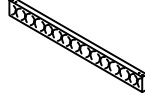
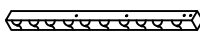
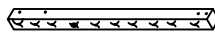
Carton	Disignation		Part	Q.TY	Hardware	
5114-Q-1	Headboard	#1		1PC	#A  8 PCS #B  32 PCS #C  32 PCS #D  32 PCS #E  32 PCS #F  1 PC	
	Footboard	#2		1PC		
	Short Canopy	#7		2PCS		
	Slat	#8		4PCS		
	Support leg	#9		4PCS		
	Feet	#10		10PCS		
5114-Q-2	Side Rail	#3		2PCS		
	Long Canopy	#6		2PCS		
5114-Q-3	HB Post	#4		2PCS		
	FB Post	#5		2PCS		

STEP 1

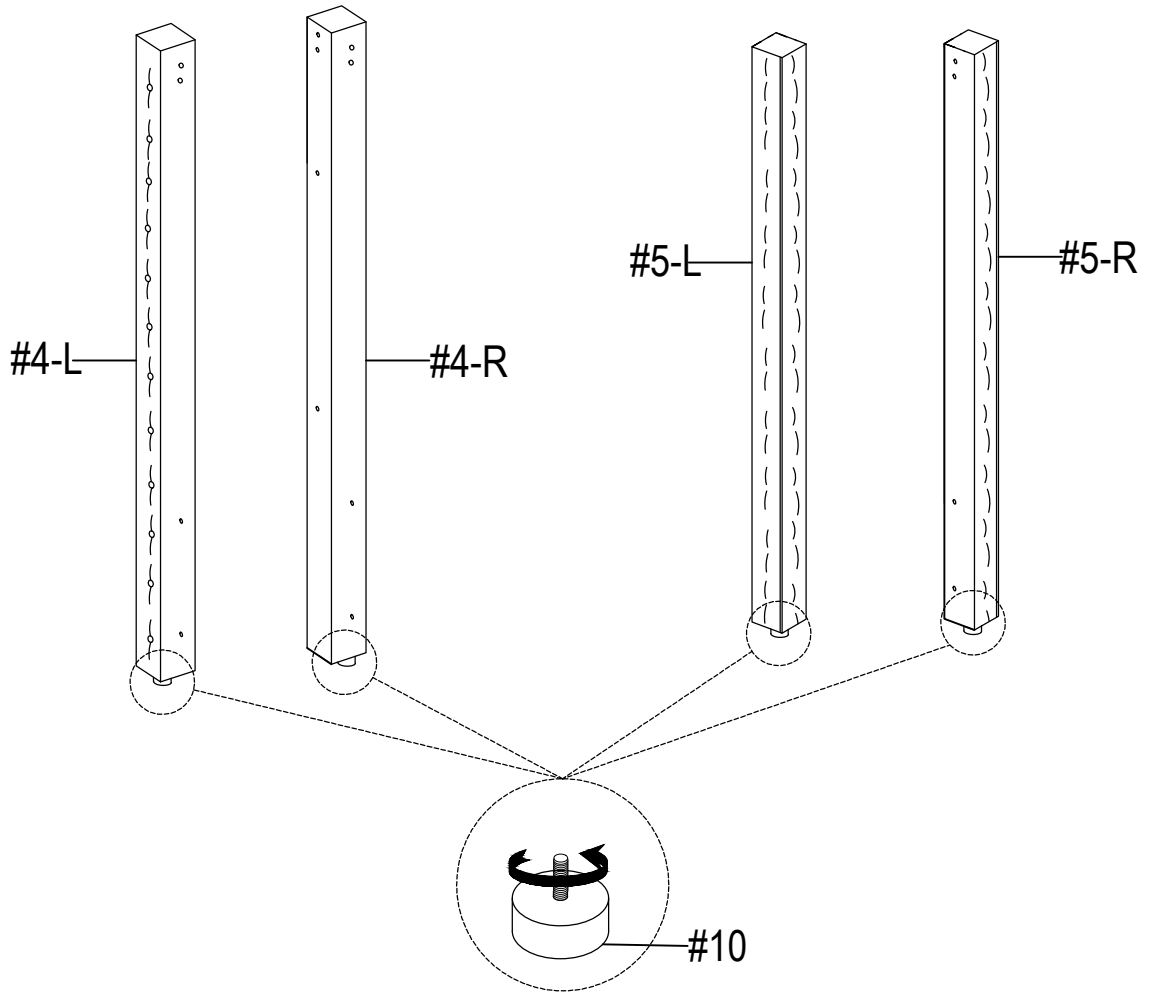

STEP 2

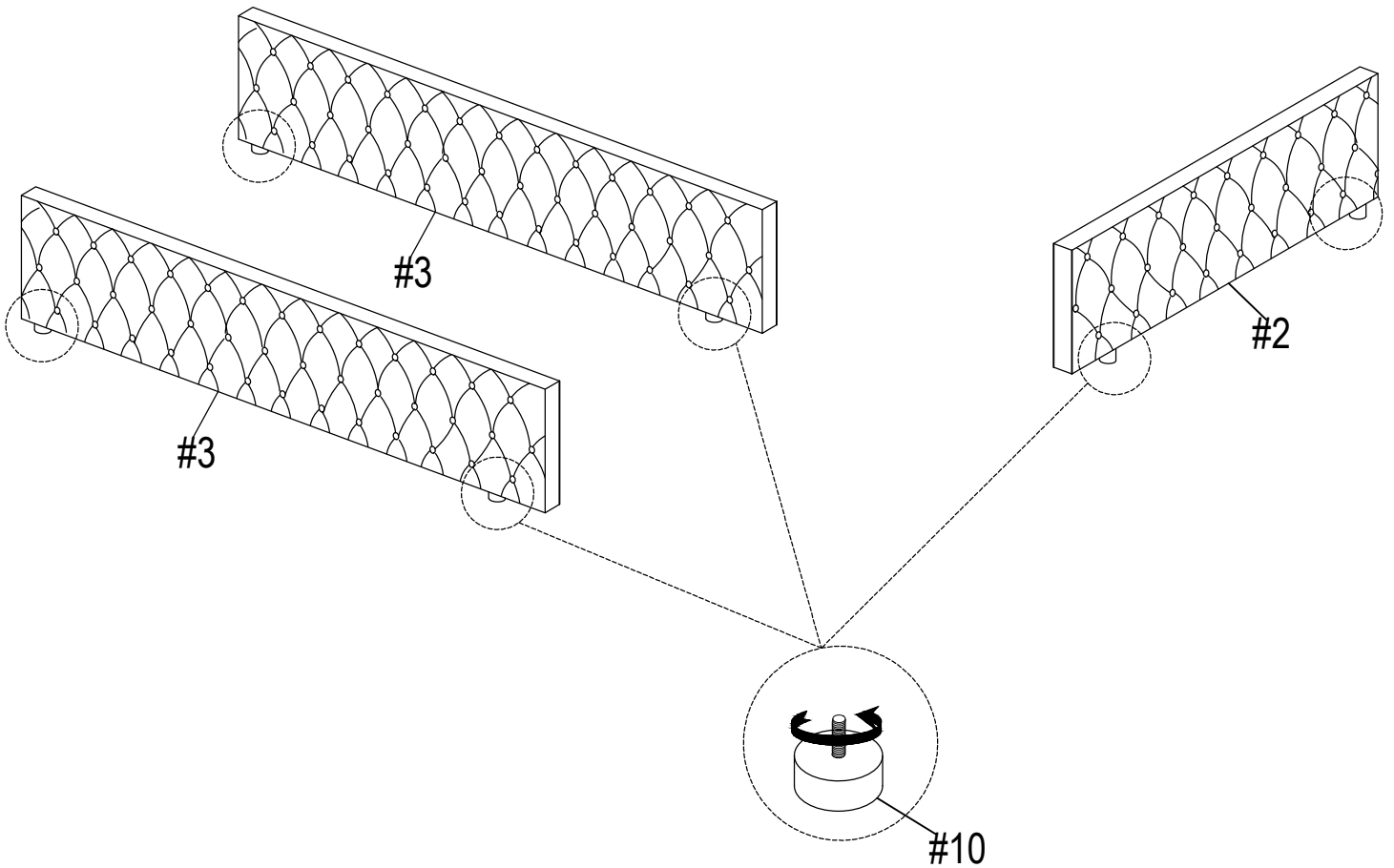

STEP 3

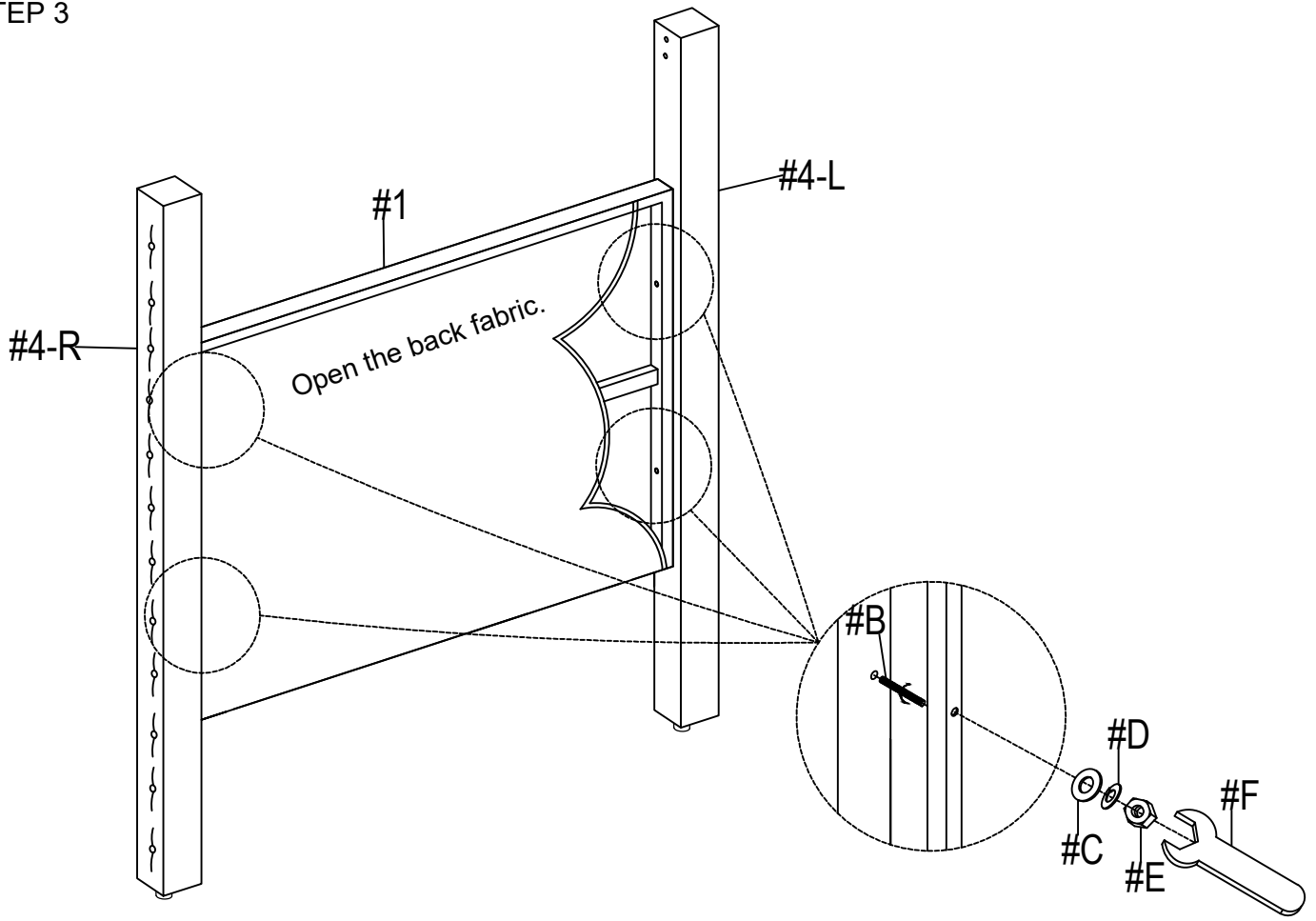

STEP 4

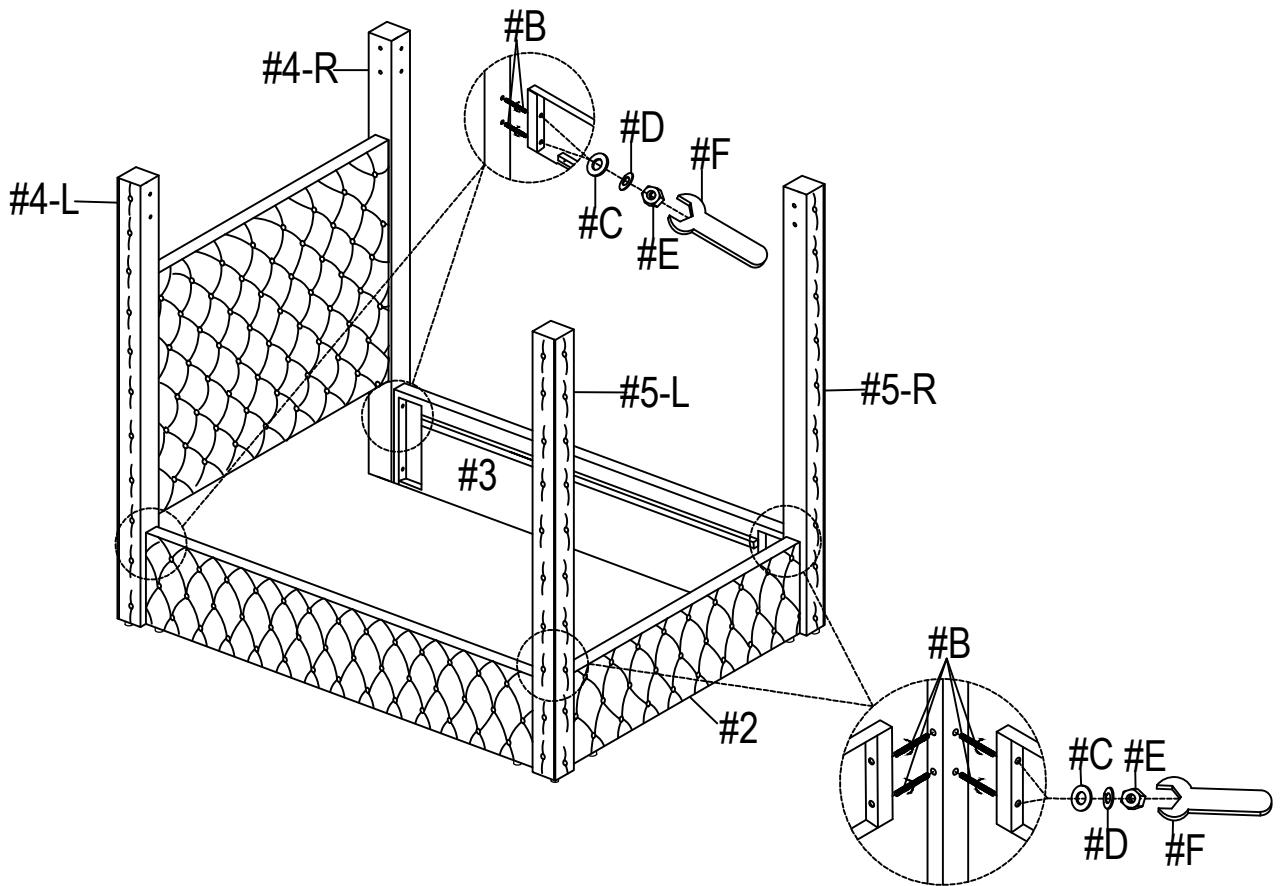

STEP 5

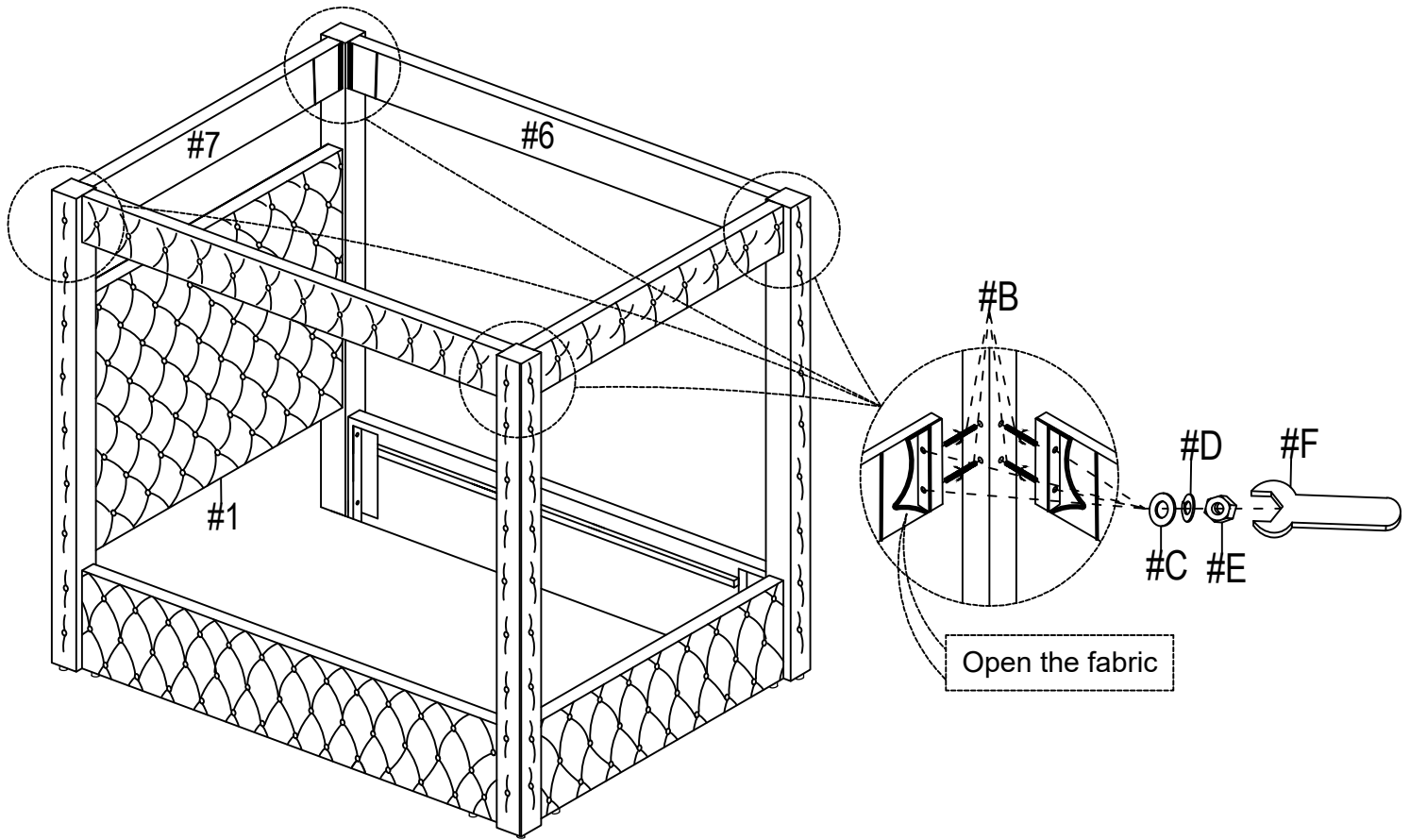

STEP 6

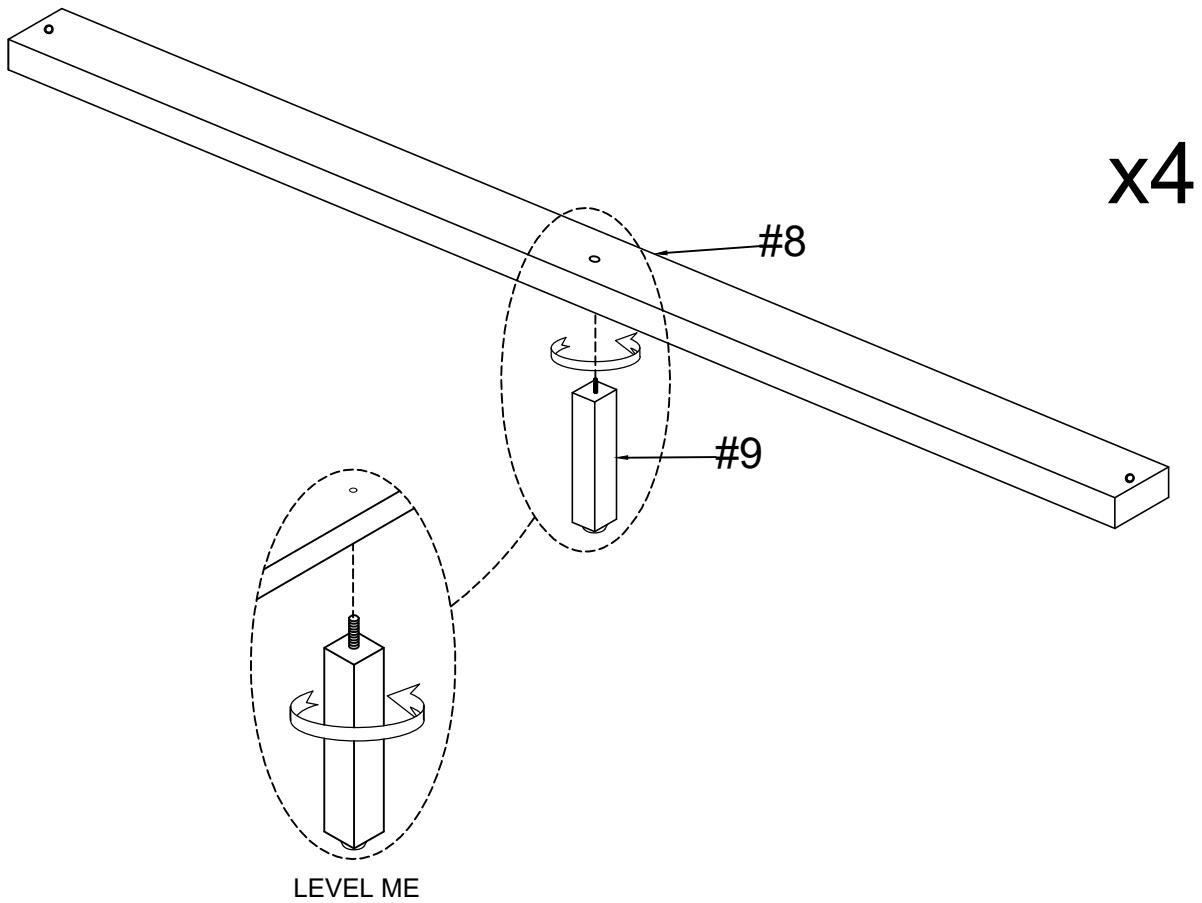

STEP 7

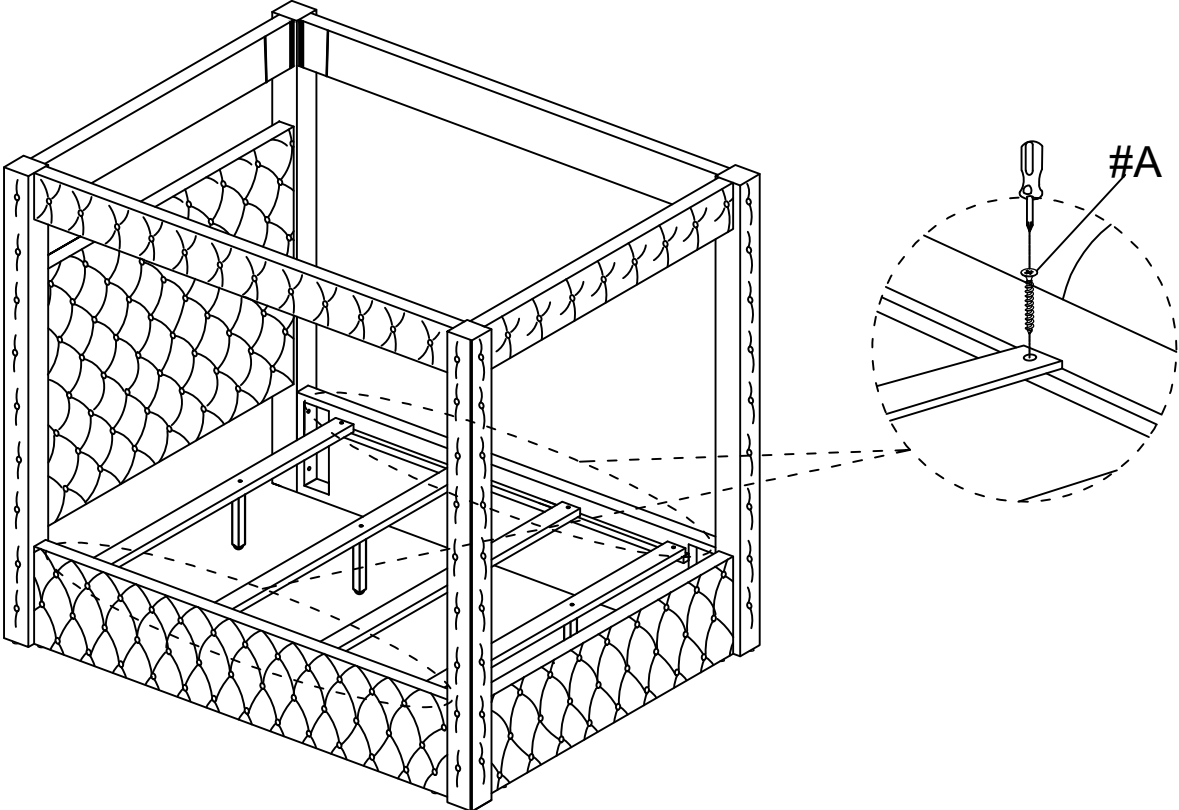

STEP 8

Assembly complete

