

# ASSEMBLY INSTRUCTION

5114-EK

## PART LIST

① HEAD BOARD

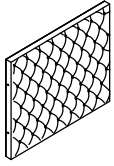

1PC

② FOOTBOARD

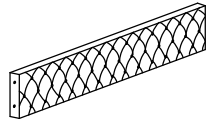

1PC

③ SIDE RAIL

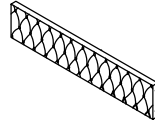

2PCS

④ HB POST (L+R)

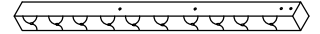

2PCS

⑤ FB POST (L+R)

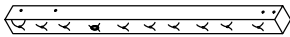

2PCS

⑥ LONG CANOPY

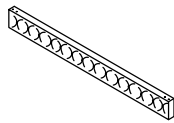

2PCS

⑦ SHORT CANOPY

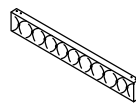

2PCS

⑧ SLAT

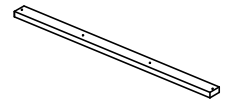

4PCS

⑨ SUPPORT LEG

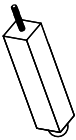

8PCS

⑩ FEET



10PCS

## HARDWARE LIST

A SCREW M4X38MM



8PCS

B THREADED STUD  
Ø5/16" X 3-1/8"

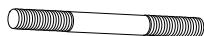

32PCS

C FLAT WASHER  
Ø5/16" X 22MM



32PCS

D LOCK WASHER  
Ø5/16"



32PCS

E HEX NUT  
Ø5/16"X12MM







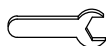

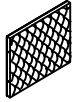

32PCS

F WRENCH 12MM

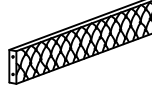
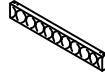
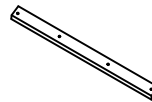

1PC

# 5114-EK is packed in 3 cases

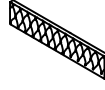
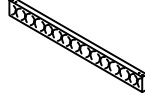
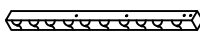
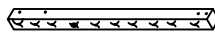
Carton	Disignation	Part	Q.TY	Hardware	
5114-EK-1	Headboard	#1 	1PC	#A  8 PCS #B  32 PCS #C  32 PCS #D  32 PCS #E  32 PCS #F  1 PC	
	Footboard	#2 	1PC		
	Short Canopy	#7 	2PCS		
	Slat	#8 	4PCS		
	Support leg	#9 	8PCS		
	Feet	#10 	10PCS		
5114-EK-2	Side Rail	#3 	2PCS		
	Long Canopy	#6 	2PCS		
5114-EK-3	HB Post	#4 	2PCS		
	FB Post	#5 	2PCS		

STEP 1

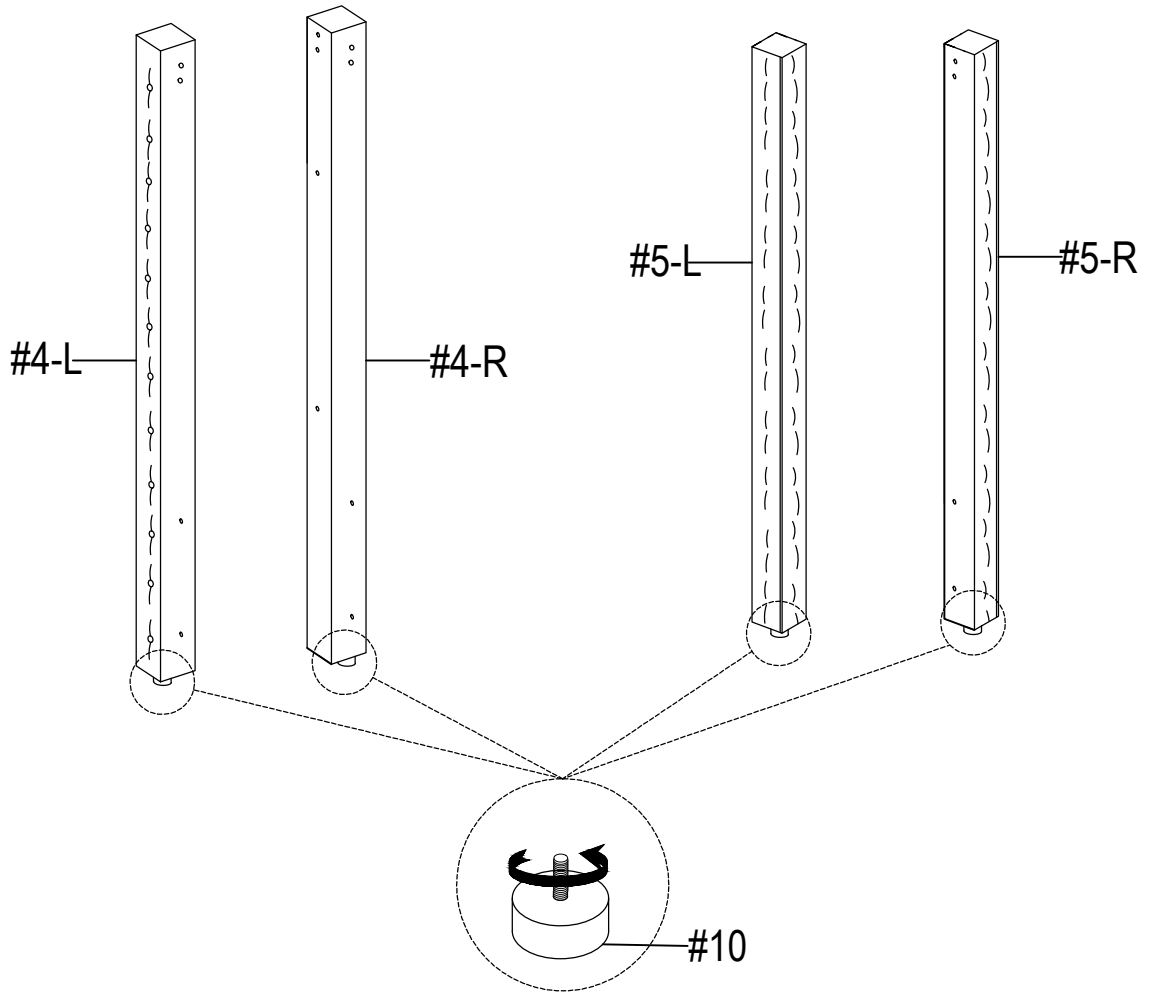

STEP 2

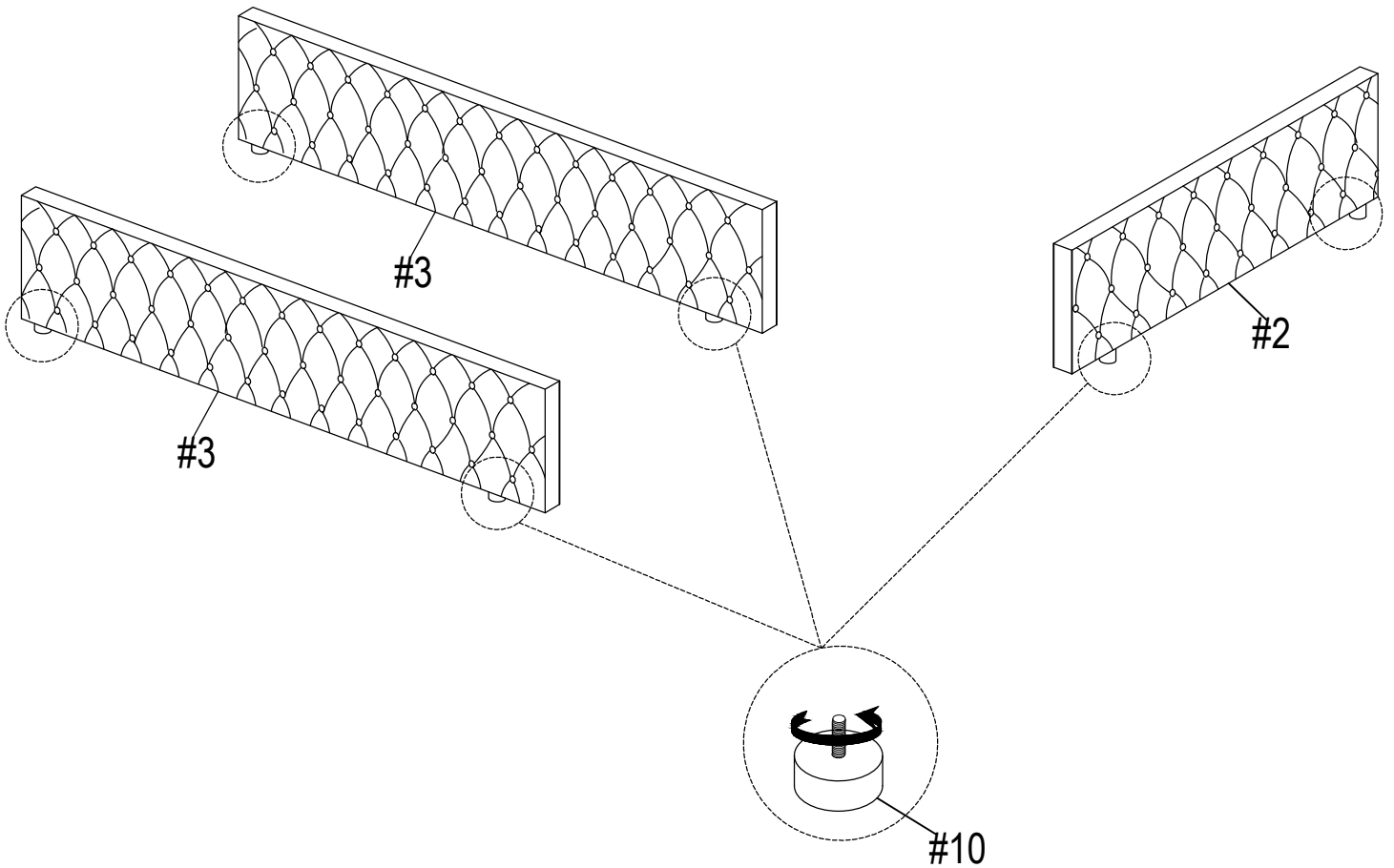

STEP 3

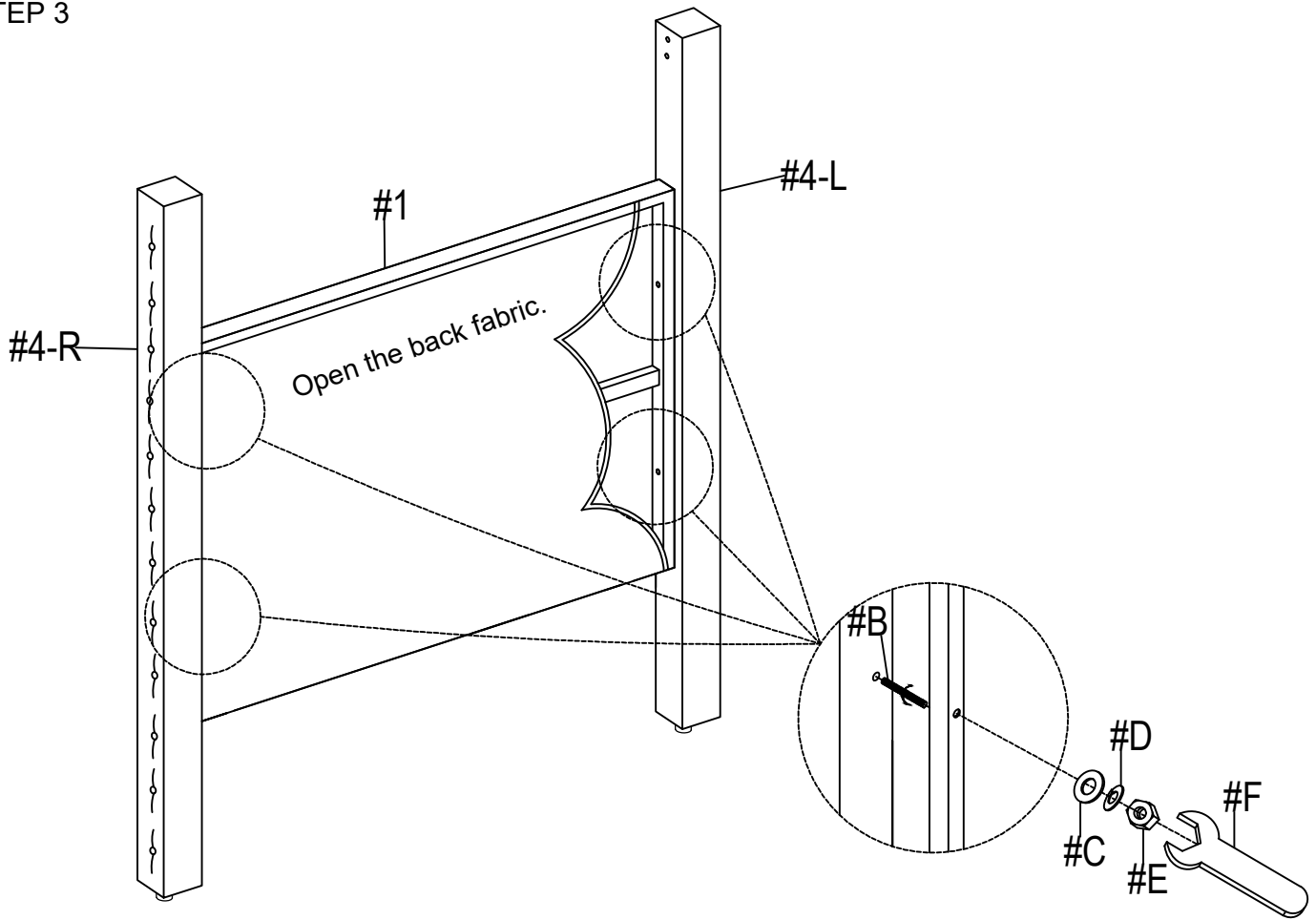

STEP 4

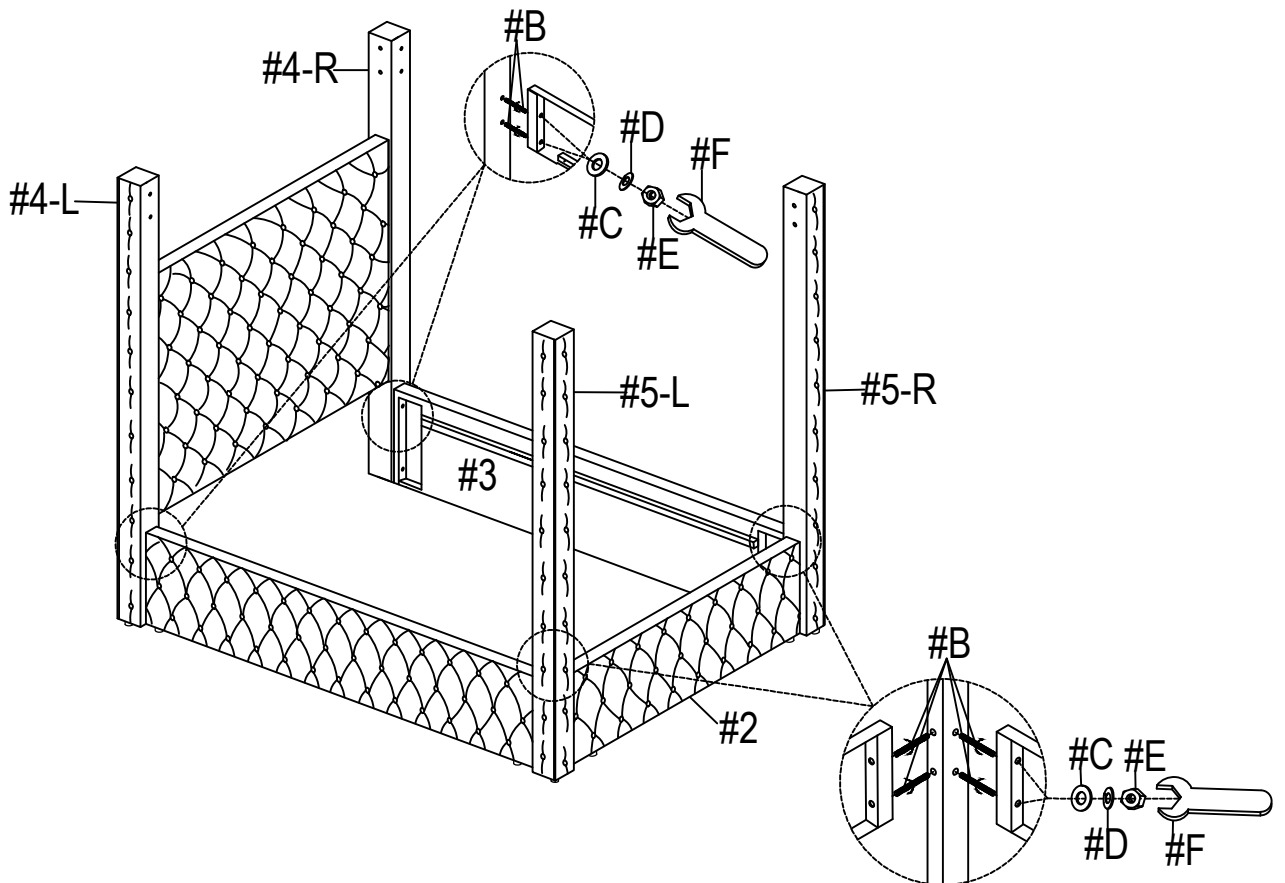

STEP 5

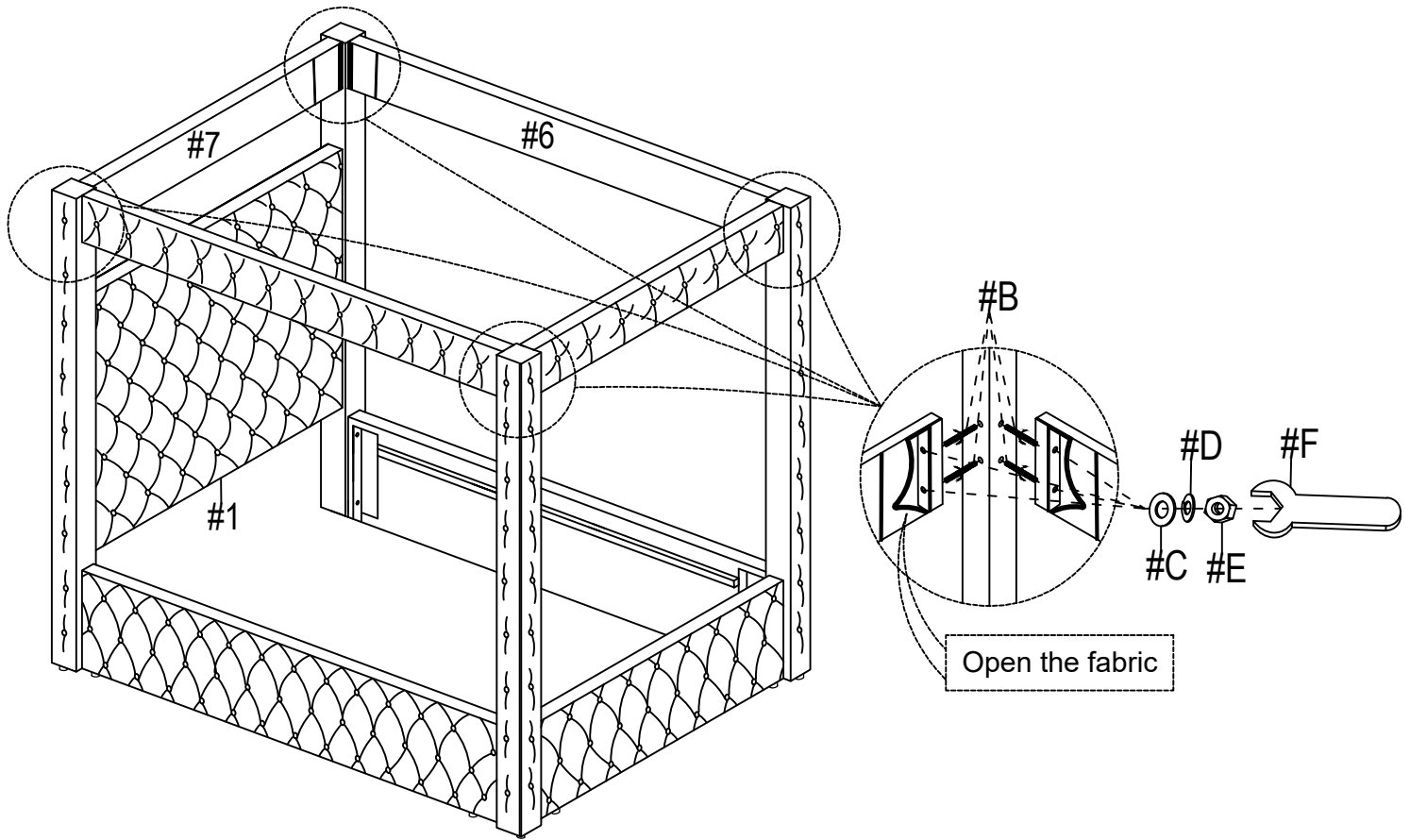

STEP 6

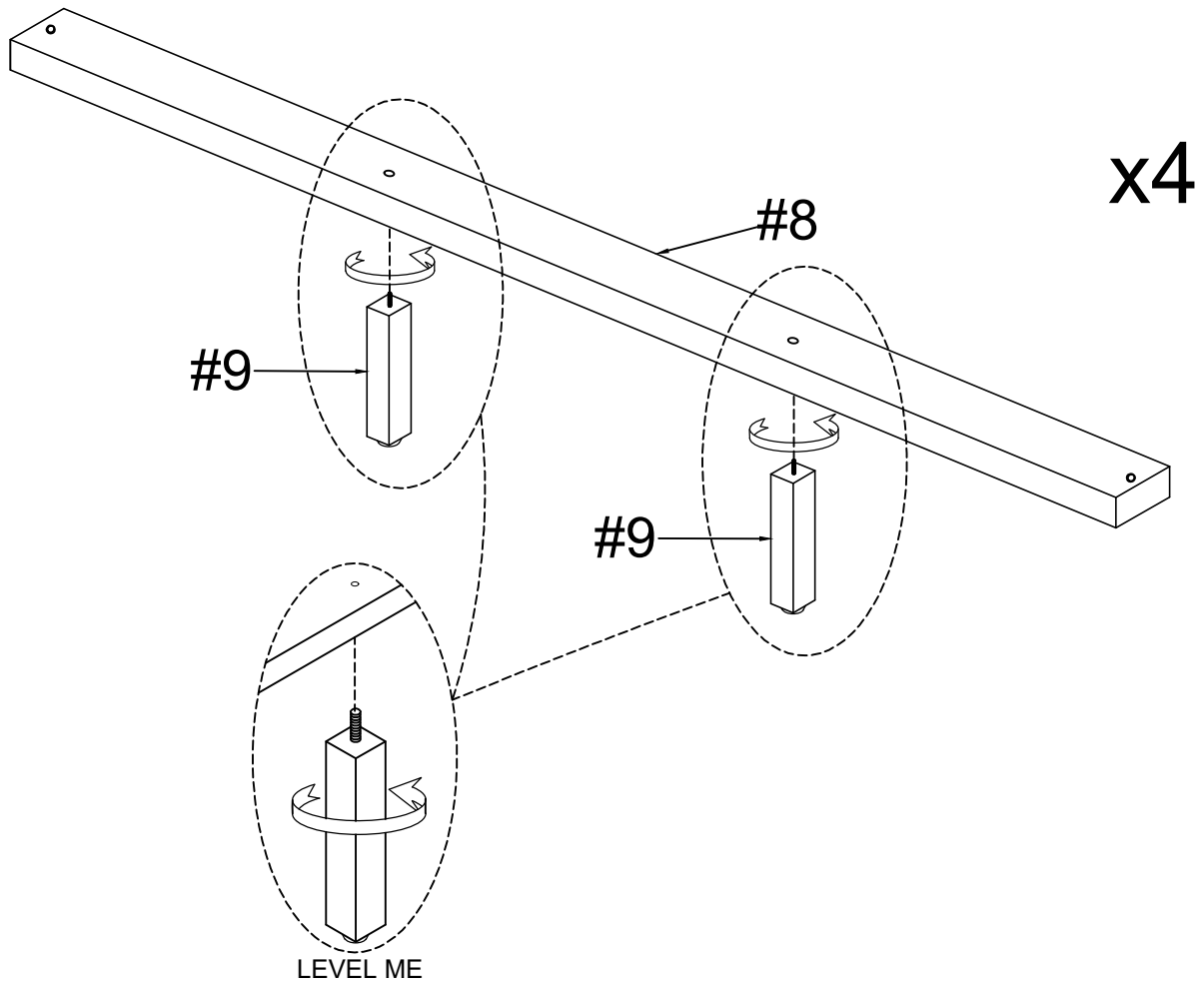

STEP 7

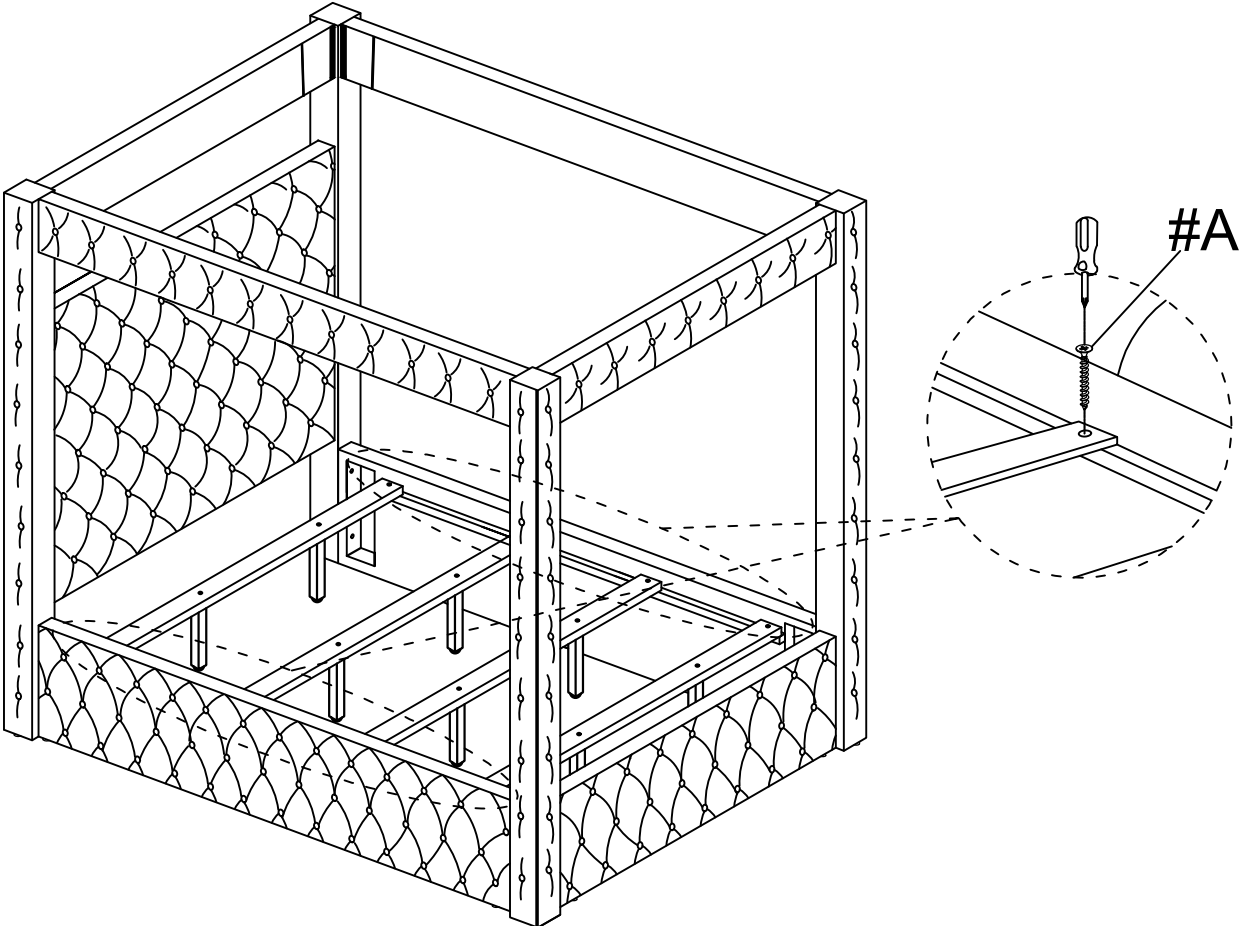

STEP 8

**Assembly complete**

