

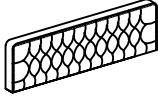



ITEM : #5091
(6' King)

Assembly Instruction

(BOX 1) #5091-K-HBFB-NH
BOX OF HEADBOARD/FOOTBOARD

A	 Headboard	1 pc
B	 B1 B2 Headboard Legs 25 x 80 x 800(H)	2 pcs
C	 Footboard	1 pc
D	 Support Leg 215mm	8 pcs
E	 Footboard Leg 100 x 32 x 90(H)	2 pcs
F	 1947mm Slat	4 pcs

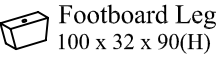
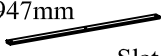
Step 1 : Fix the headboard and footboard with legs as shown. Please follow the label to identify the correct legs to be fixed.

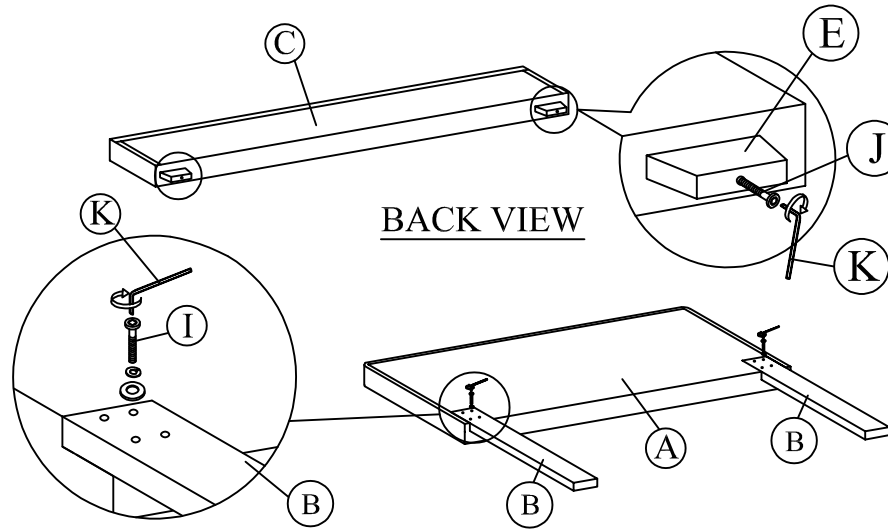

Step 2 : Attach the JCBB Bolt (N) to the headboard (A) and footboard (C).

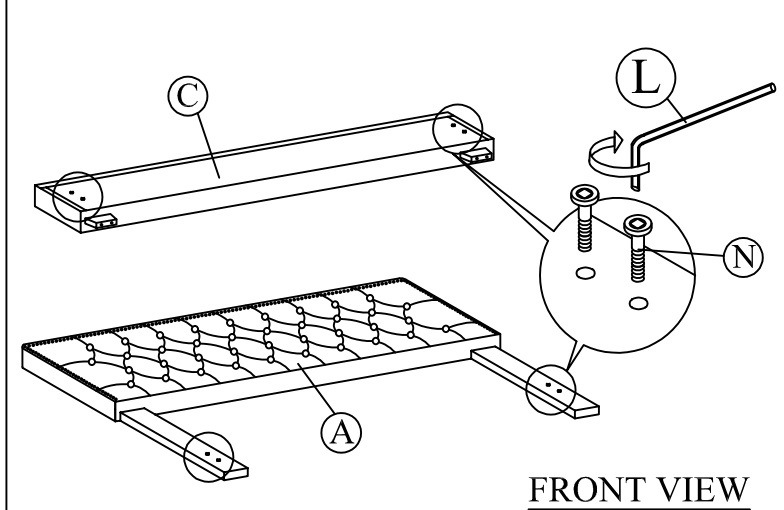

(BOX 2) #5091-KQ-RAIL
BOX OF SIDE RAIL

G	 Side Rail	2 pcs
---	--	-------



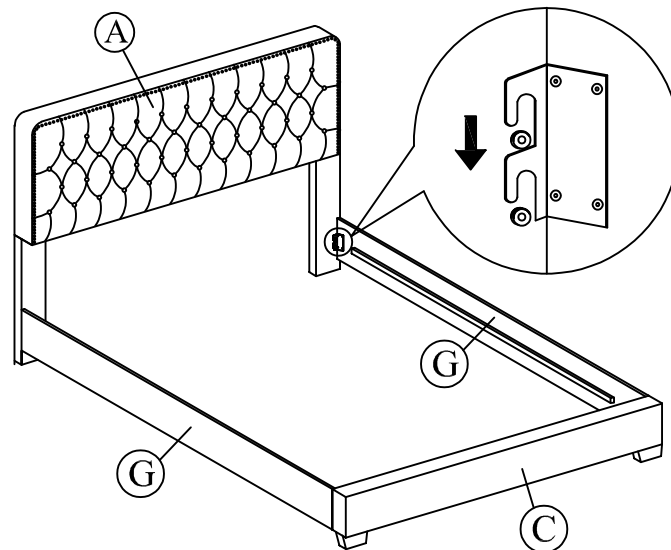

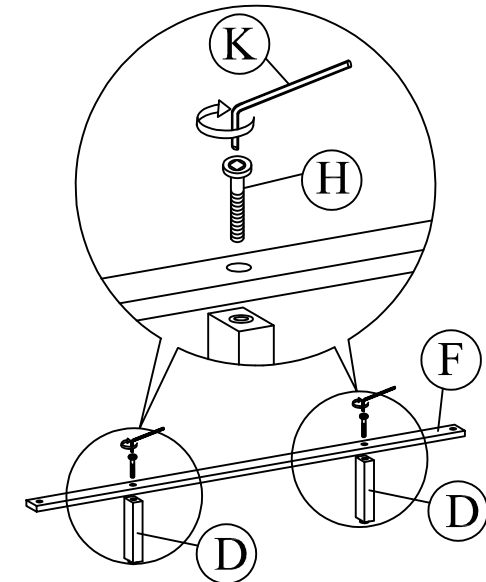

Step 3 : Attach Side Rail (G) to Headboard (A) and Footboard (C) by pushing the bracket down to fit it.

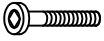

Step 4 : Attach the support legs (D) to the slats (F).



(BOX 1) #5091-K-HBFB-NH
BOX OF HARDWARE

H	 JCBC M6 X 40	8 pcs
I	 JCBC M6 X 45 With Spring Washers with Flat Washers	8 pcs
J	 JCBC M6 X 50	2 pcs
K	 M4 x 100mm	1 pc
L	 M5 x 70mm	1 pc
M	 CSK M4 x 32mm	8 pcs
N	 JCBB M8 x 20	8 pcs

Step 5 : Tighten the 4 Corner with Allen Key (L). Install the bed slats to side rail. Tighten the slats with CSK screw. The distance of the slats should be sufficient to obtain desirable bed stability.

