







ASSEMBLY INSTRUCTION #2836-L

HARDWARE LIST

NO	SKETCH	HARDWARE	QTY
1		JCBC M8 x 25	4 Pcs
2		L key	1 Pcs

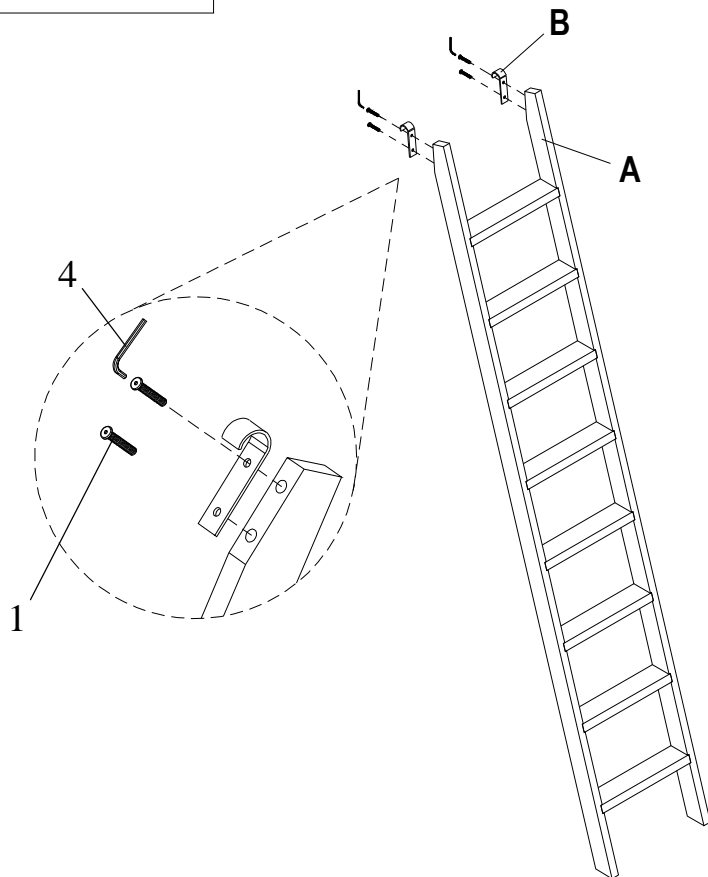
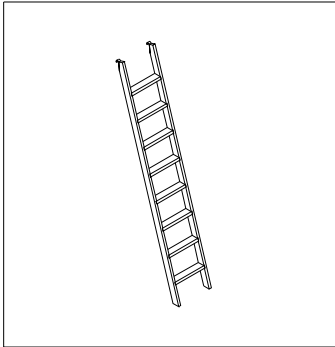

NO	DESCRIPTION	QTY
A		1 Pcs
B		2 Pcs



ASSEMBLY INSTRUCTION #2836-L

HARDWARE LIST

NO	SKETCH	HARDWARE	QTY
1		JCBC M8 x 25	4 Pcs
2		L key	1 Pcs

NO	DESCRIPTION	QTY
A		1 Pcs
B		2 Pcs

