

ASSEMBLY INSTRUCTIONS

MODEL : 2831

CRWN

2831T-3671-TOP / 2831T-3671-BASE

Thank you for purchasing this quality product. Be sure to check all packing material carefully for small parts. Which may have come loose inside the carton during shipment. Identify and count all parts and compare with the hardware list as below.





BOX 1 (TABLE TOP)

Part List	No.	Picture	Description	Qty
	A		Table Top	1 Pc

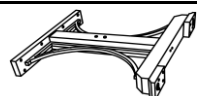
THE HARDWARE IS LOCATED IN THE PACKING ITEMS (BOX 1).

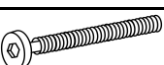
BOX 2 (TABLE BASE)

Part List	No.	Picture	Description	Qty
	B		Cross Bar	1 Pc
	C		Base	2 Pcs

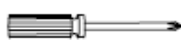
Hardware List	No.	Picture	Description	Qty
	1		Allen Wrench	1 Pc
	2		Bolt	4 Pcs
	3		Lock Washer	4 Pcs
	4		Dowel	2 Pcs
	5		Wood Button	4 Pcs
	6		Waferhead Screw	16 Pcs
	7		Philips Head Screw Driver (*)	1 Pc

(*) The manufacturer does not provide item 7.

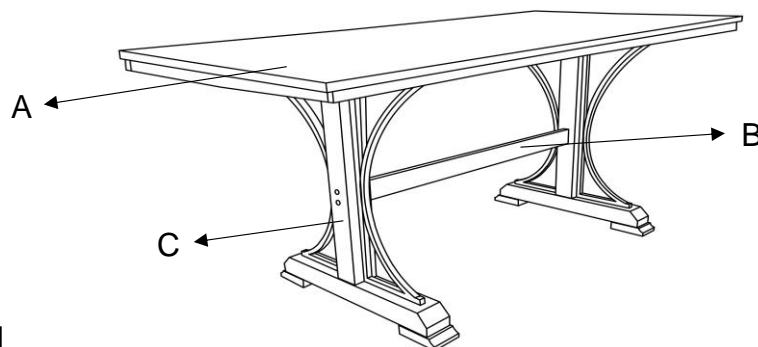

PARTS DETAILS

ASSEMBLY INSTRUCTIONS

MODEL : 2831

CRWN

2831T-3671-TOP / 2831T-3671-BASE

Thank you for purchasing this quality product. Be sure to check all packing material carefully for small parts which may have come loose inside the carton during shipment. Identify and count all parts and compare with the Part List as below.

** Assemble the table on flat, soft surface such as carpet or cloth to prevent scratching table finish. Read all the instruction and study the drawings carefully before starting the assemble process.

