





# ASSEMBLY INSTRUCTIONS

MODEL : 2733



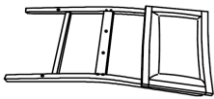

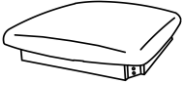

CRWN

2733S-24

Thank you for purchasing this quality product. Be sure to check all packing material carefully for small parts. Which may have come loose inside the carton during shipment. Identify and count all parts and compare with the hardware list as below.

Part List	No.	Picture	Description	Qty
	A		Back Rest	1 Pc
	B		Front Leg L/R	2 Pcs
	C		Seater With Frame	1 Pc
	D		Side Stretcher L/R	2 Pcs
	E		Front Stretcher	1 Pc

Hardware List	No.	Picture	Description	Qty
	1		Allen Wrench	1 Pc
	2		Short Bolt With Washer	2 Pcs
	3		Medium Bolt With Washer	4 Pcs
	4		Long Bolt With Washer	4 Pcs
	5		Screw	6 Pcs
6		Philips Head Screw Driver (*)	1 Pc	

(\*) The manufacturer does not provide item 6.

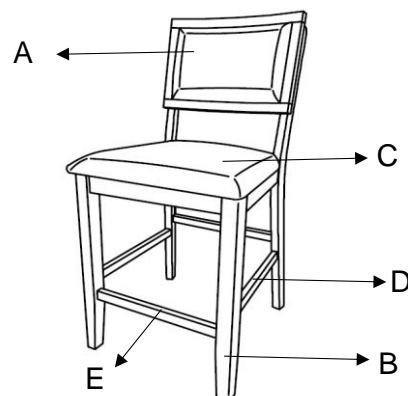

PARTS DETAILS

THE HARDWARE IS LOCATED IN THE PACKING ITEMS.

# ASSEMBLY INSTRUCTIONS

MODEL : 2733

**CRWN**  
2733S-24

Thank you for purchasing this quality product. Be sure to check all packing material carefully for small parts which may have come loose inside the carton during shipment. Identify and count all parts and compare with the Part List as below.

**NOTE: ASSEMBLE THE CHAIR ON A FLAT & SOFT SURFACE. DO NOT TIGHTEN ALL THE SCREWS UNTIL THE CHAIR HAS BEEN PUT A FLAT/HARD SURFACE ADJUST & LEVEL ALL. THE LEGS SO THAT THEY DO NOT WOBBLE. ONCE ADJUSTED THEN TIGHTEN ALL THE SCREWS.**

