







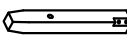

ASSEMBLY INSTRUCTION INSTRUCCIONES

2321DW-SET BENCH 2321DW-SET BANCA

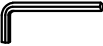
No	DESCRIPTION		Q'TY
A	SEAT		1 pc/pieza
B	LEFT LEG		2 pcs/piezas
C	RIGHT LEG		2 pcs/piezas
D	LONG CROSSBAR		1 pc/pieza
E	SHORT CROSSBAR		2 pcs/piezas
F	ALLEN KEY	 Ø1/4"*2-1/4"L	1 pc/pieza
G	BOLT	 1/4"*20*2-3/8"	8 pcs/piezas
H	SCREW	 M3*15mm	6 pcs/piezas
I	SCREW	 M4*38mm	4 pcs/piezas
J	TRIANGULAR IRON	 50*40*2mm	2 pcs/piezas

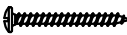

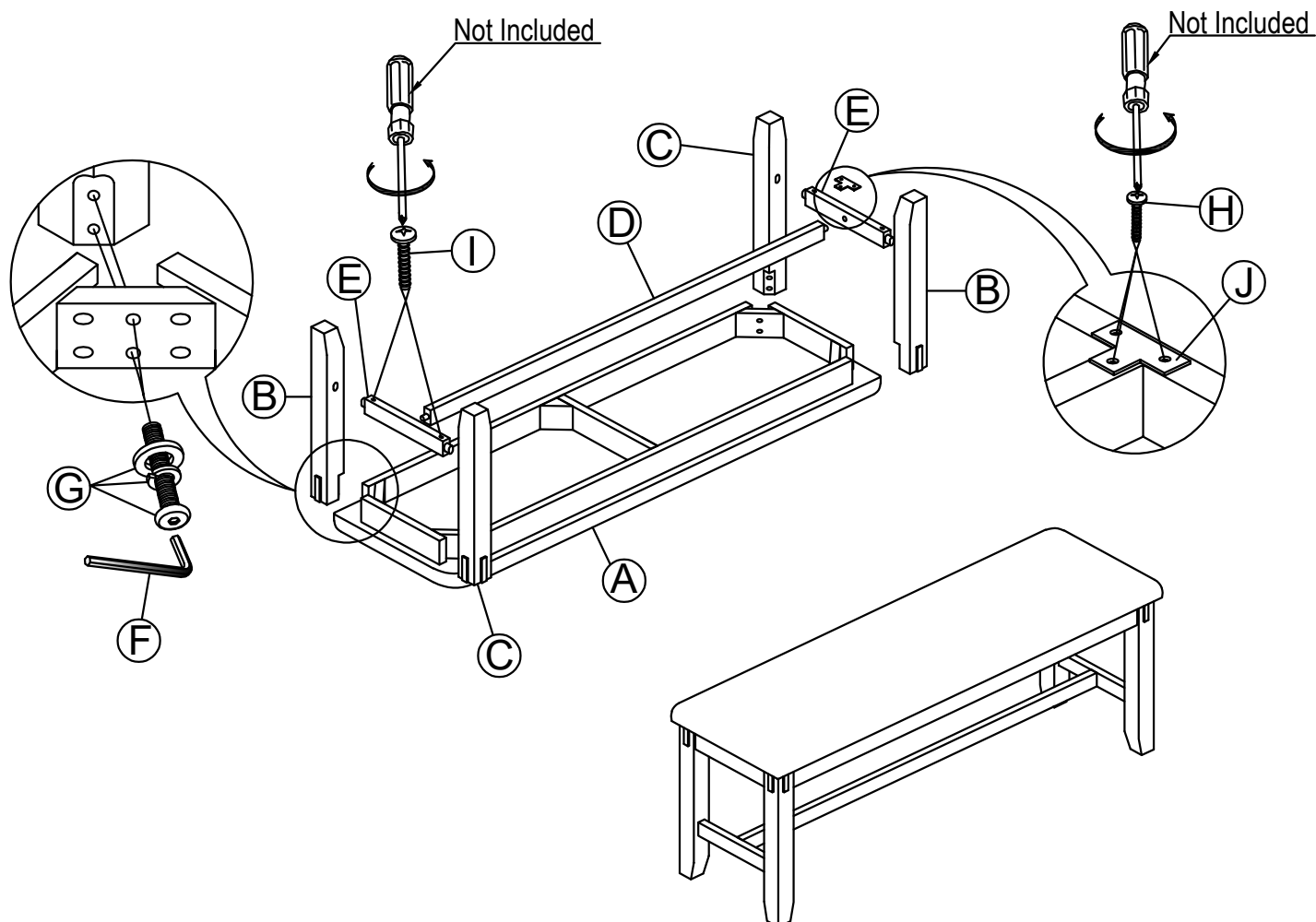
DO NOT TIGHTEN ALL BOLT UNTIL COMPLETELY ASSEMBLED.
NO APRETER LOS TORNILLOS HASTA ARMAR COMPLETAMENTE.