

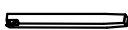



# ASSEMBLY INSTRUCTION INSTRUCCIONES

## 2254SET-GY/2254DW-SET TABLE 2254SET-GY/2254DW-SET MESA

### PARTS LIST LISTA DE ARRITES

1		1 PC/PIEZA
2		4 PCS/PIEZAS

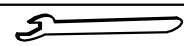
A	 Nut 5/16"*13mm	8 PCS/PIEZAS
B	 Spring washer 5/16"*19mm	8 PCS/PIEZAS
C	 Lock washer 5/16"*11mm	8 PCS/PIEZAS
D	 Wrech 13*90mm	1 PC/PIEZA

### ASSEMBLY INSTRUCTION INSTRUCCIONES

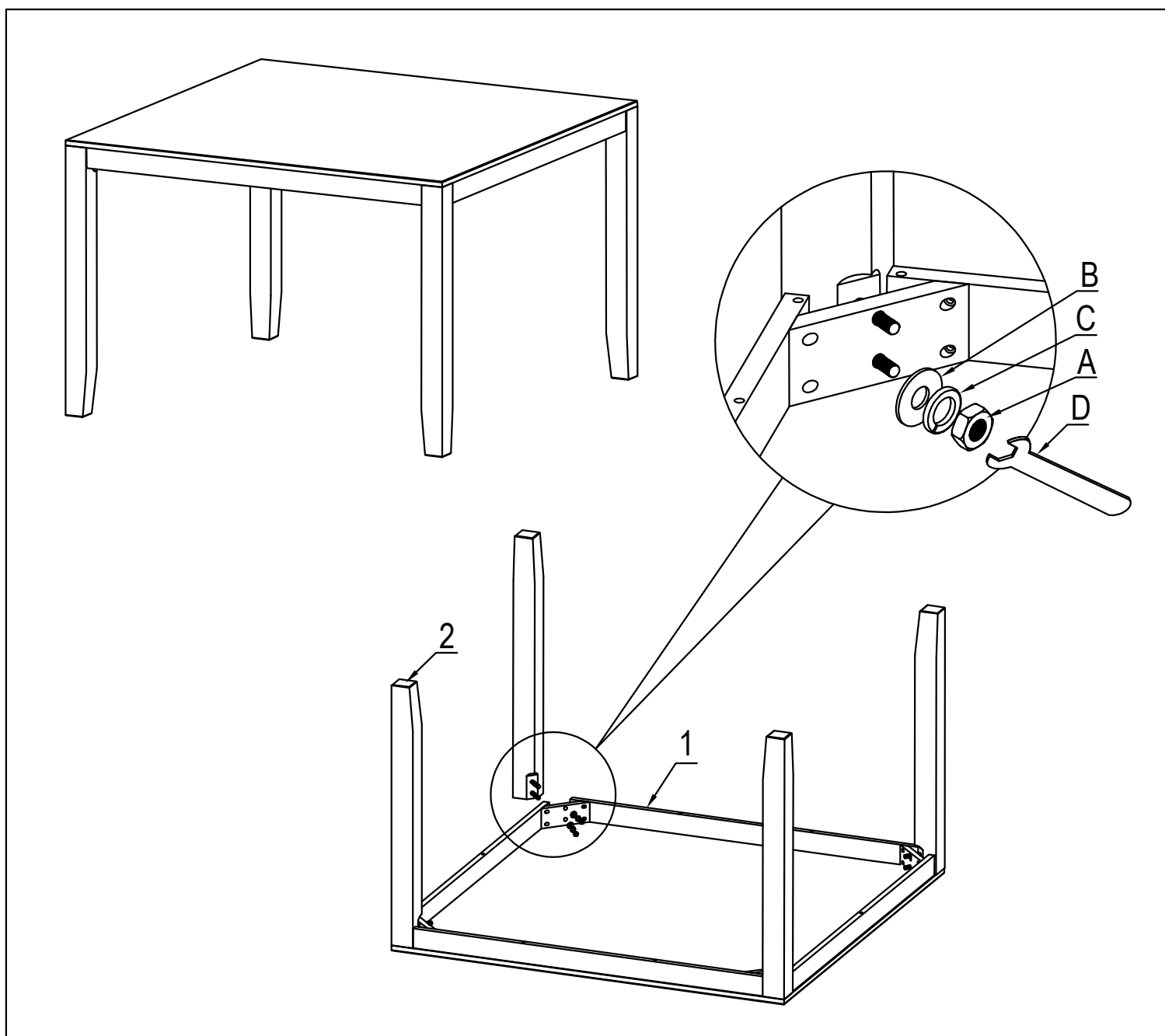





DO NOT TIGHTEN ALL BOLT UNTIL COMPLETELY ASSEMBLED.  
NO APRETER LOS TORNILLOS HASTA ARMAR COMPLETAMENTE.

# ASSEMBLY INSTRUCTION INSTRUCCIONES

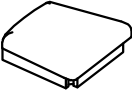
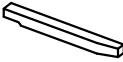
# 2254SET-GY/2254DW-SET CHAIR 2254SET-GY/2254DW-SET SILLA

## PARTS LIST LISTA DE ARRITES

1		1 PC/PIEZA
2		1 PC/PIEZA
3		2 PCS/PIEZAS

A		Bolt 1/4''*20*3-1/4'' (chair back leg corner)	4 PCS/PIEZAS
B		Bolt 1/4''*20*2-1/4'' (front leg)	4 PCS/PIEZAS
C		Bolt 1/4''*20*1-3/4'' (chair back center)	3 PCS/PIEZAS
D		Allen key 4*60mm	1 PC/PIEZA

## ASSEMBLY INSTRUCTION INSTRUCCIONES

**Step 1**

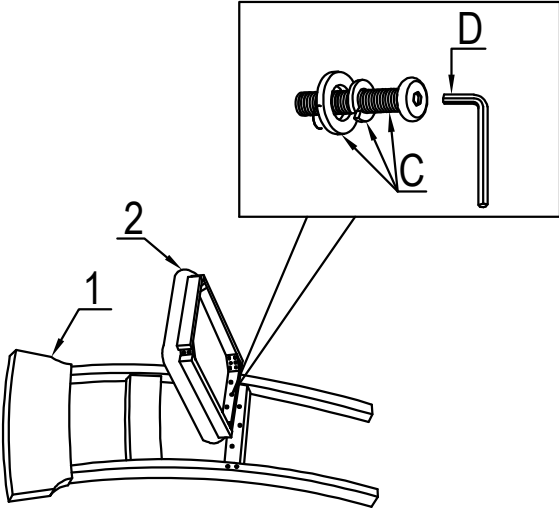

**Step 2**

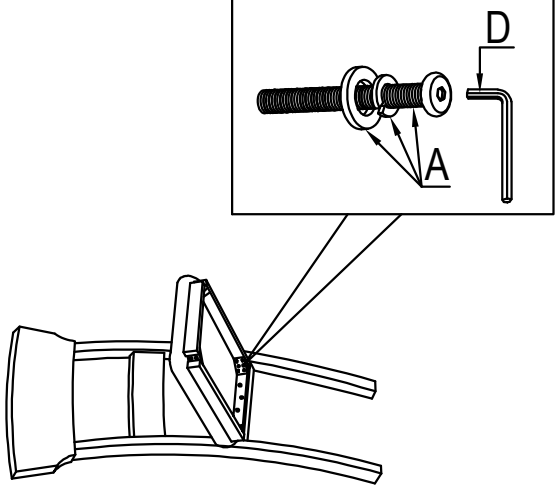

**Step 3**

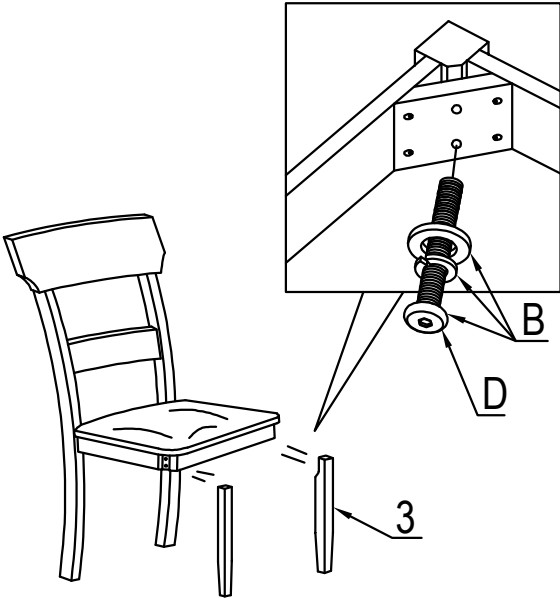

**Step 4**

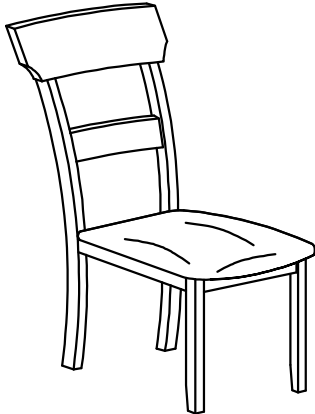

DO NOT TIGHTEN ALL BOLT UNTIL COMPLETELY ASSEMBLED.  
NO APRETER LOS TORNILLOS HASTA ARMAR COMPLETAMENTE.