



ASSEMBLY INSTRUCTIONS

MODEL : 2134

CRWN

2134T-4280

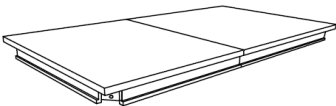
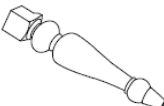
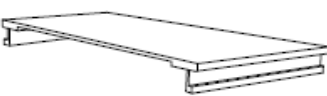
Thank you for purchasing this quality product. Be sure to check all packing material carefully for small parts. Which may have come loose inside the carton during shipment. Identify and count all parts and compare with the hardware list as below.

Part List	No.	Picture	Description	Qty
	A		Table Top	1 Pc
	B		Leg	4 Pcs
	C		Leaf	1 Pc
Hardware List	No.	Picture	Description	Qty
	1		Allen Wrench	1 Pc
	2		Bolt With Washer	8 Pcs

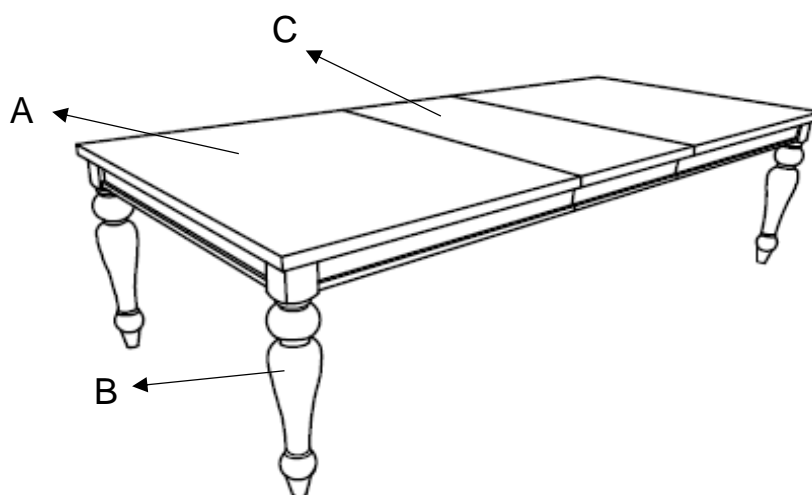

PARTS DETAILS

THE HARDWARE IS LOCATED IN THE PACKING ITEMS.

ASSEMBLY INSTRUCTIONS

MODEL : 2134

CRWN

2134T-4280

Thank you for purchasing this quality product. Be sure to check all packing material carefully for small parts which may have come loose inside the carton during shipment. Identify and count all parts and compare with the Part List as below.

** Assemble the table on flat, soft surface such as carpet or cloth to prevent scratching table finish. Read all the instruction and study the drawings carefully before starting the assemble process.

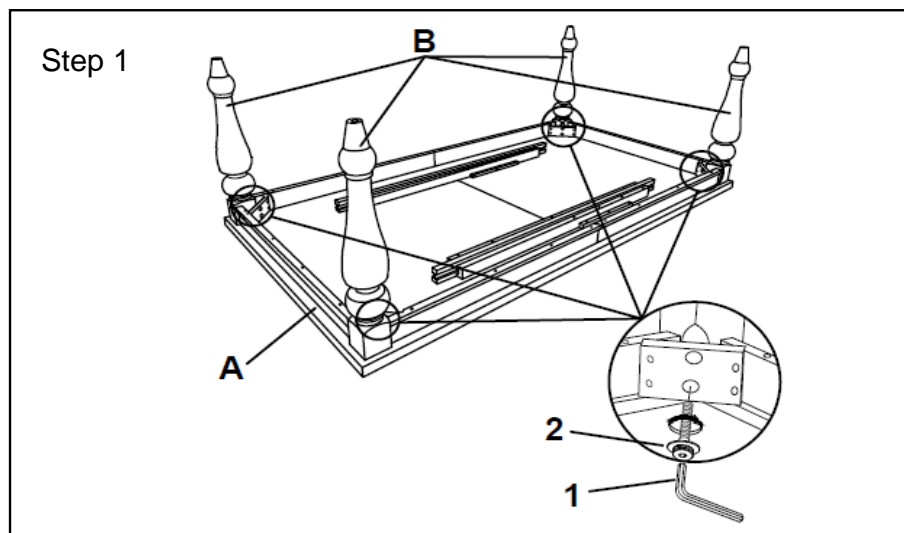

Step 2

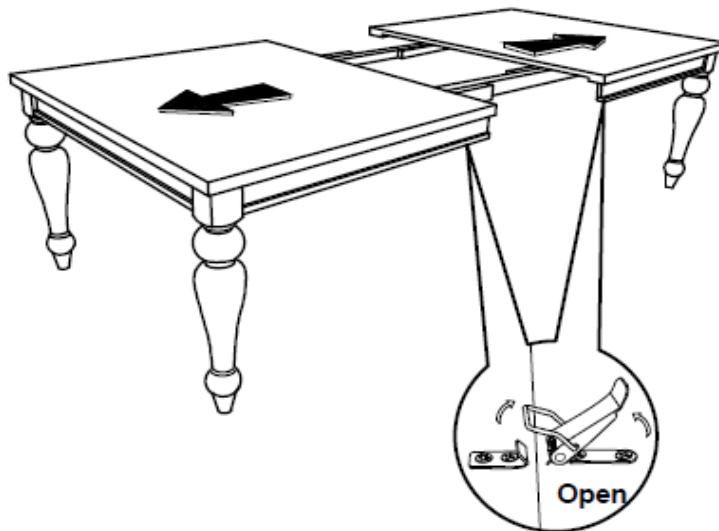

ASSEMBLY INSTRUCTIONS

MODEL : 2134

CRWN

2134T-4280

Thank you for purchasing this quality product. Be sure to check all packing material carefully for small parts which may have come loose inside the carton during shipment. Identify and count all parts and compare with the Part List as below.

** Assemble the table on flat, soft surface such as carpet or cloth to prevent scratching table finish. Read all the instruction and study the drawings carefully before starting the assemble process.

