



# ASSEMBLY INSTRUCTIONS #1666

## HARDWARE LIST

NO	SKETCH	HARDWARE	QTY
1		JCBC M8 x 80mm	4 pcs
2		JCBC M8 x 40mm	2 pcs
3		Spring Washer M8	10 pcs
4		Flat Washer	10 pcs
5		Hexagonal Nut M8	4 pcs
6		Allen Key	1 pc
7		Wrench Key	1 pc

## PART LIST

NO	DESCRIPTION	SKETCH	QTY
A	Backrest		1 pc
B	Wood Seat		1 pc
C	Leg		2 pcs

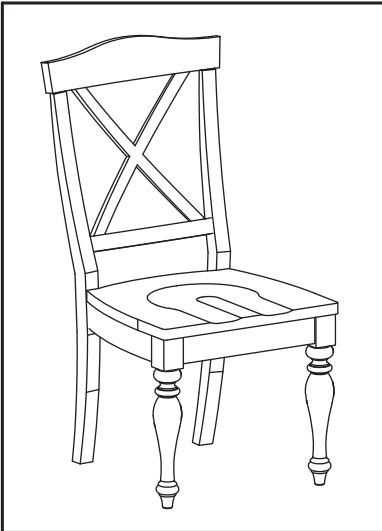

## ASSEMBLY STEP

### STEP 1

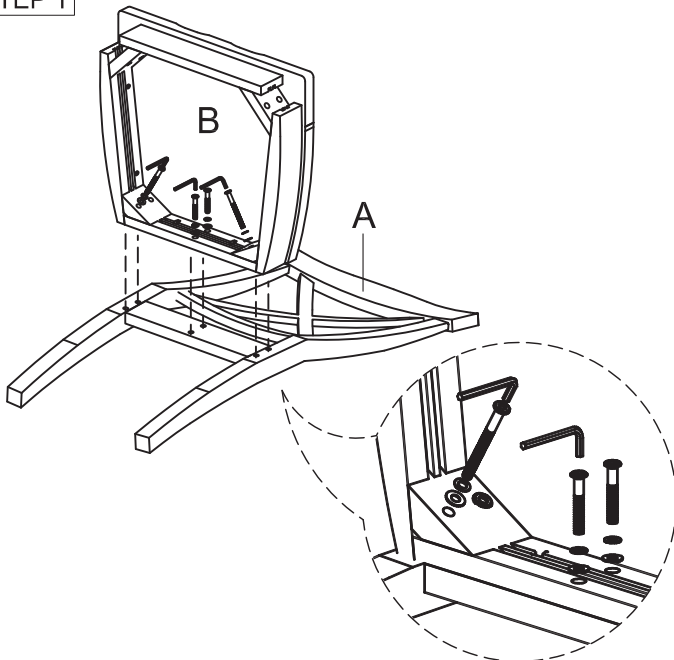

### STEP 2

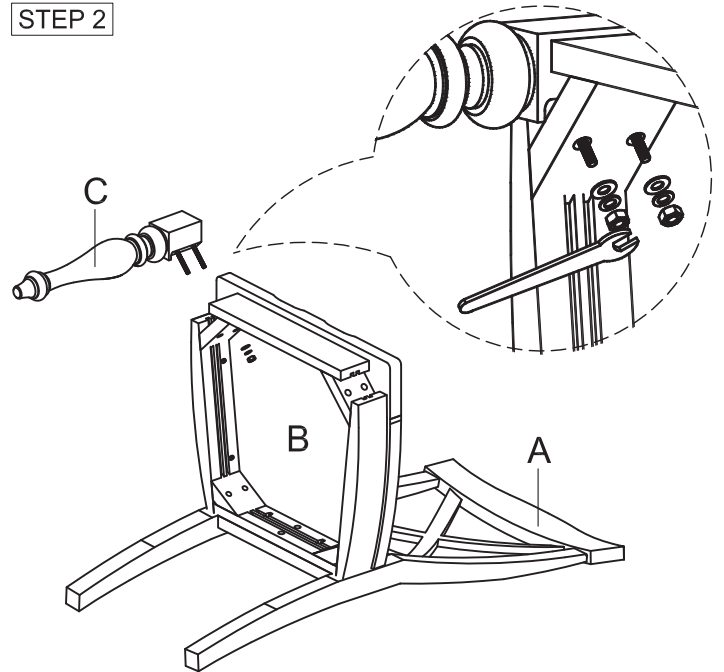

### STEP 3

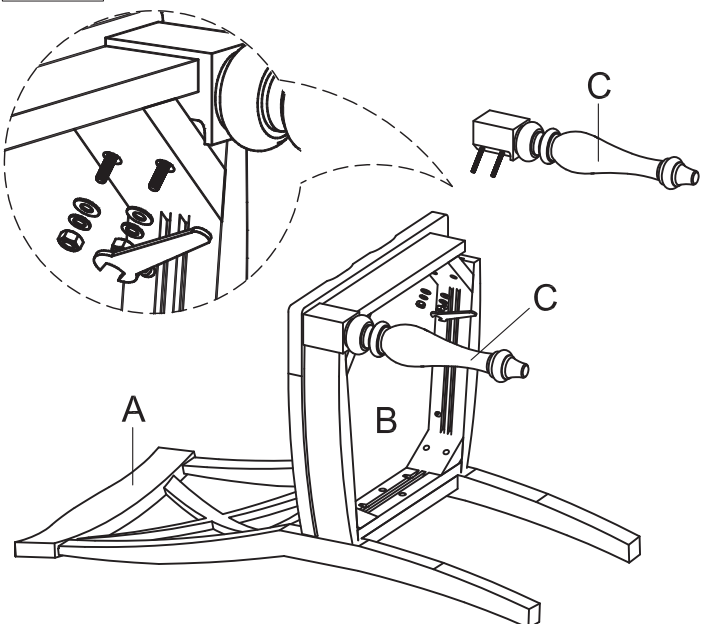

### FINISH

