

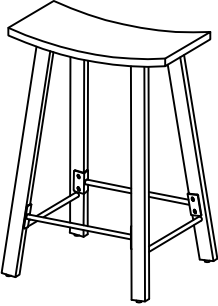

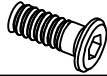



ASSEMBLY INSTRUCTION #1659 - 24

HARDWARE LIST

PART LIST

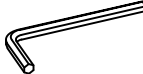
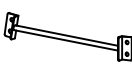
	NO	SKETCH	HARDWARE	QTY	NO	DESCRIPTION	SKETCH	QTY
	1		JCBC M6 x 15 MM	16 pcs	A	Seat		1 pc
	2		Flat Washer M6	16 pcs	B	Leg		2 pcs
	3		Allen Key	1 pc	C	Stretcher		2 pcs

ASSEMBLY STEP

STEP 1

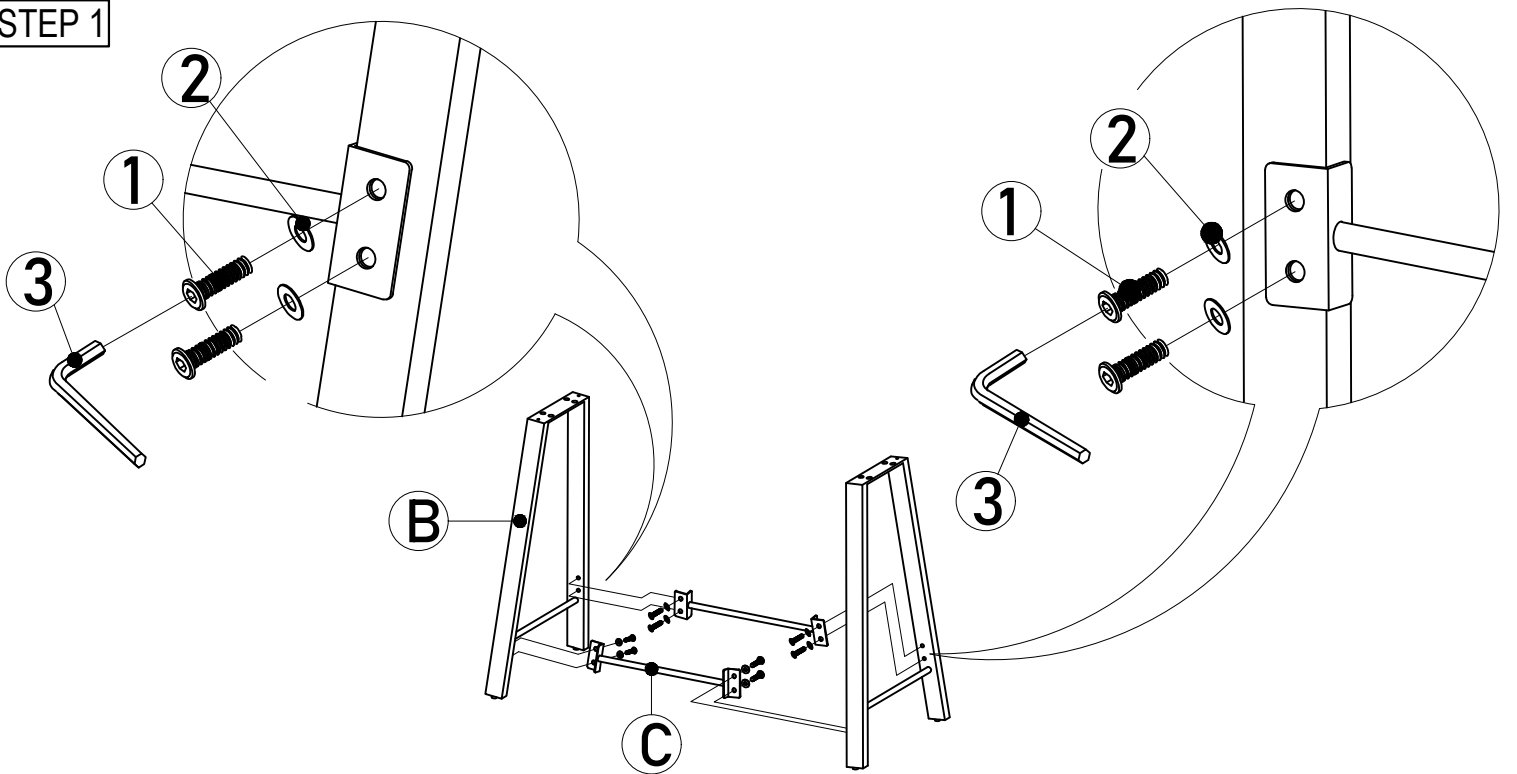

STEP 2

