



ASSEMBLY INSTRUCTIONS #1655-24 #1655-30

HARDWARE LIST

NO	SKETCH	HARDWARE	QTY
1		JCBC M6 x 20mm	4 pcs
2		Flat Washer	4 pcs
3		Allen Key	1 pc

PART LIST

NO	DESCRIPTION	SKETCH	QTY
A	Wood Seat		1 pc
B	Metal Leg		1 pc

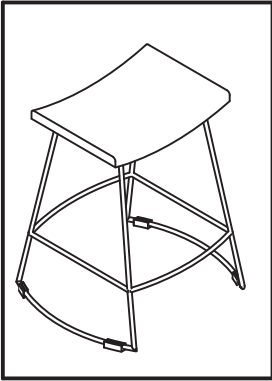

ASSEMBLY STEP

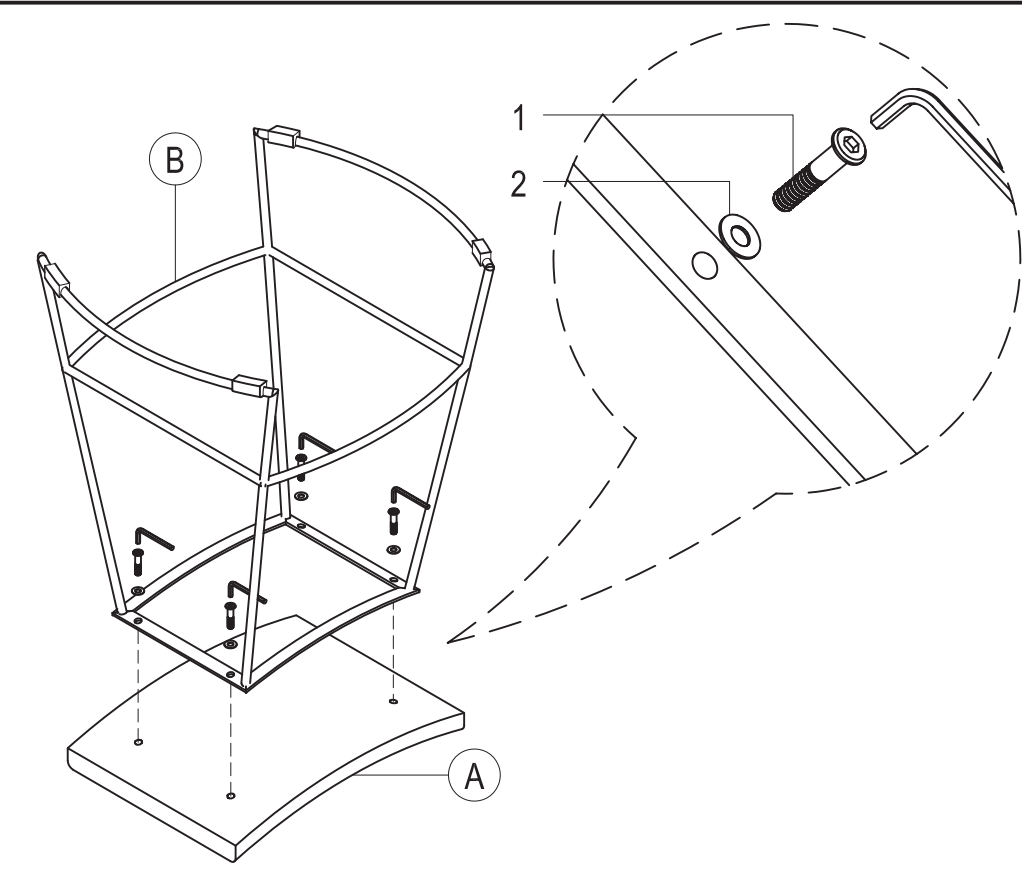

ASSEMBLY INSTRUCTIONS #1655-24 #1655-30

HARDWARE LIST

NO	SKETCH	HARDWARE	QTY
1		JCBC M6 x 20mm	4 pcs
2		Flat Washer	4 pcs
3		Allen Key	1 pc

PART LIST

NO	DESCRIPTION	SKETCH	QTY
A	Wood Seat		1 pc
B	Metal Leg		1 pc

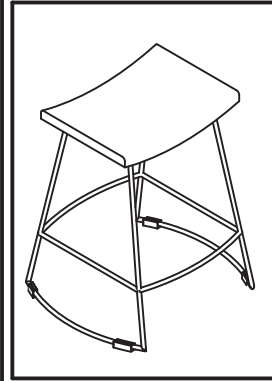

ASSEMBLY STEP

