

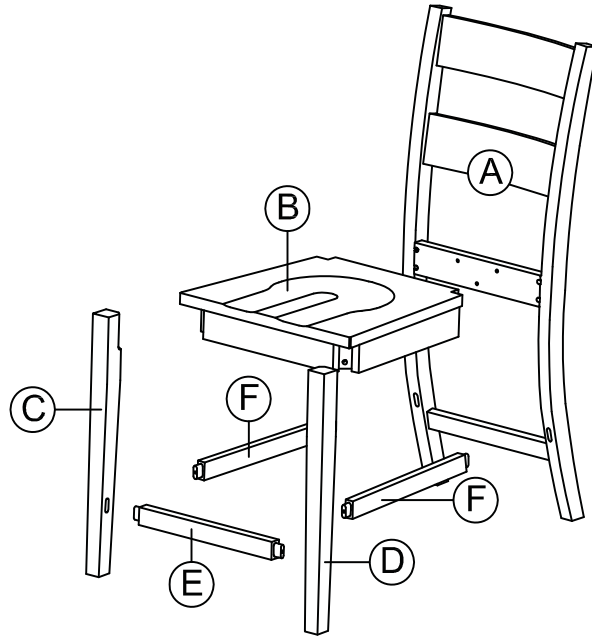

ASSEMBLY INSTRUCTIONS #1508-24

- A 1pc
- B 1pc
- C 1pc
- D 1pc
- E 1pc
- F 2pcs



G. JCBC M6 x 80mm (4pcs)



H. JCBC M6 x 40mm (3pcs)

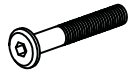

I. Spring Washer M6 (7pcs)



J. Washer Plat M6 (7pcs)



K. Allen Key M6 (1pc)

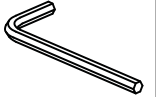

L. Hexagonal Nut M8 (4pcs)



M. Spring Washer M8 (4pcs)



N. Washer Plat M8 (4pcs)



O. Screw Ø8 x 2" (6pcs)

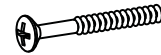

P. Wrench Key (1pc)



STEP 1

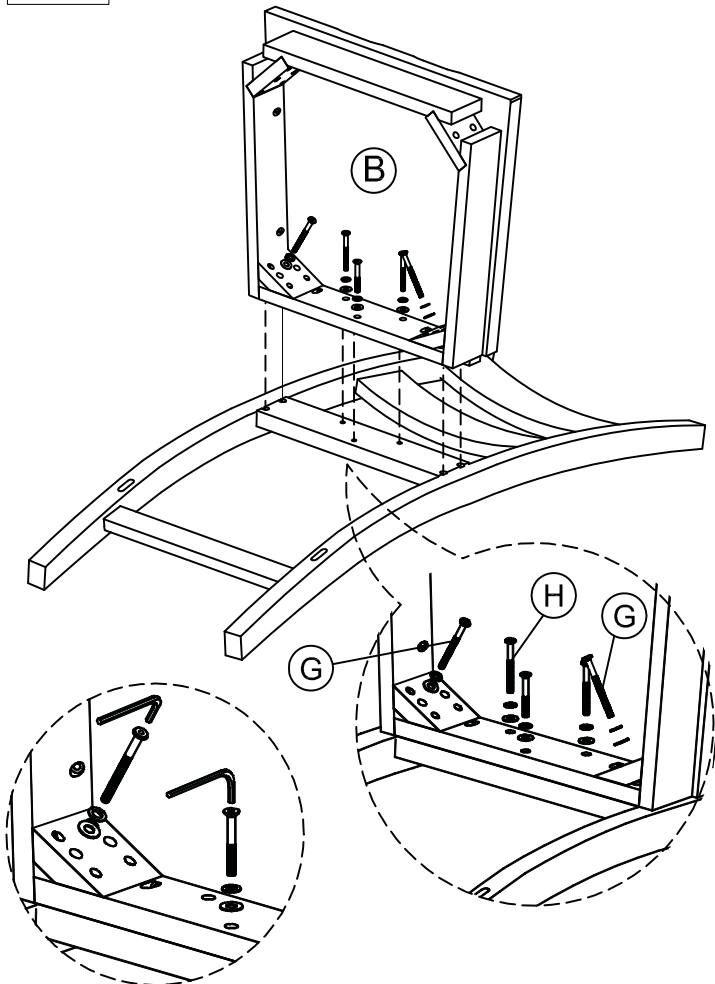

STEP 2

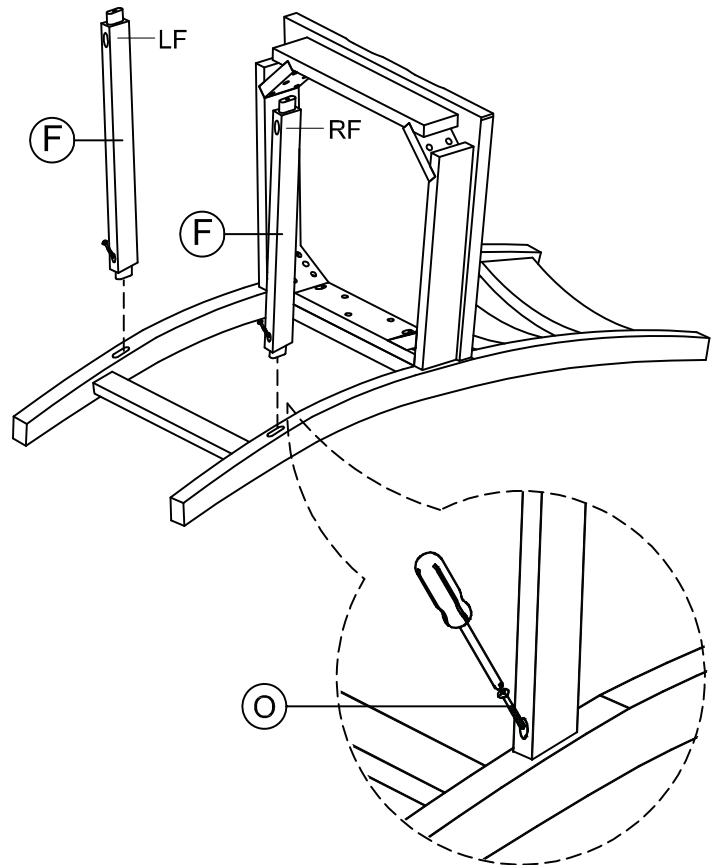

STEP 3

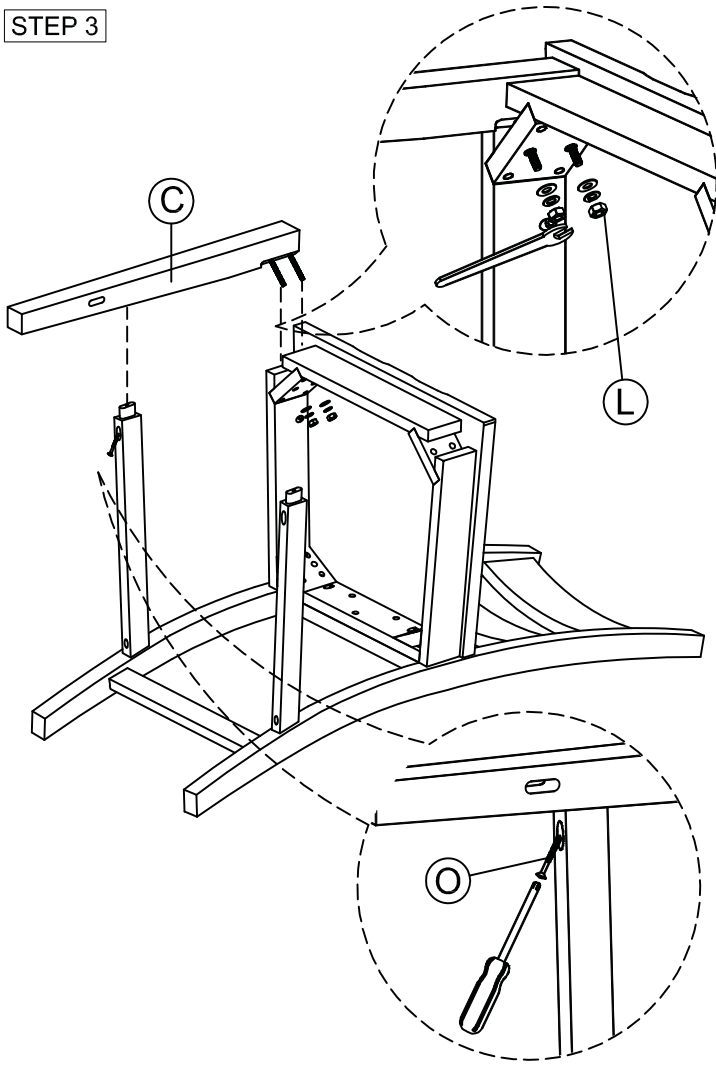

STEP 4

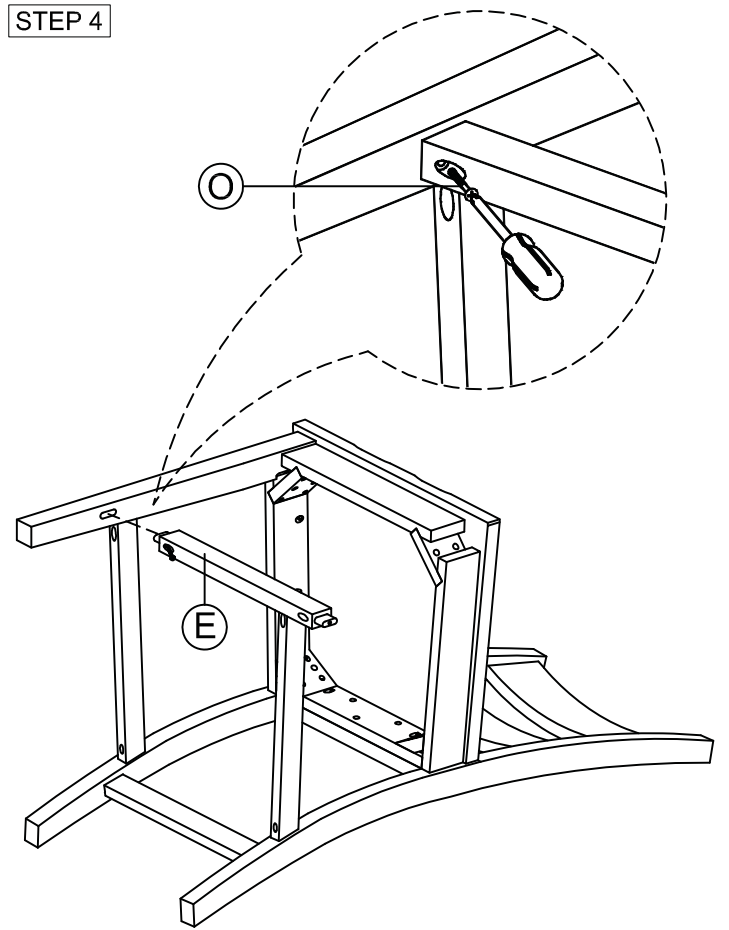

STEP 5

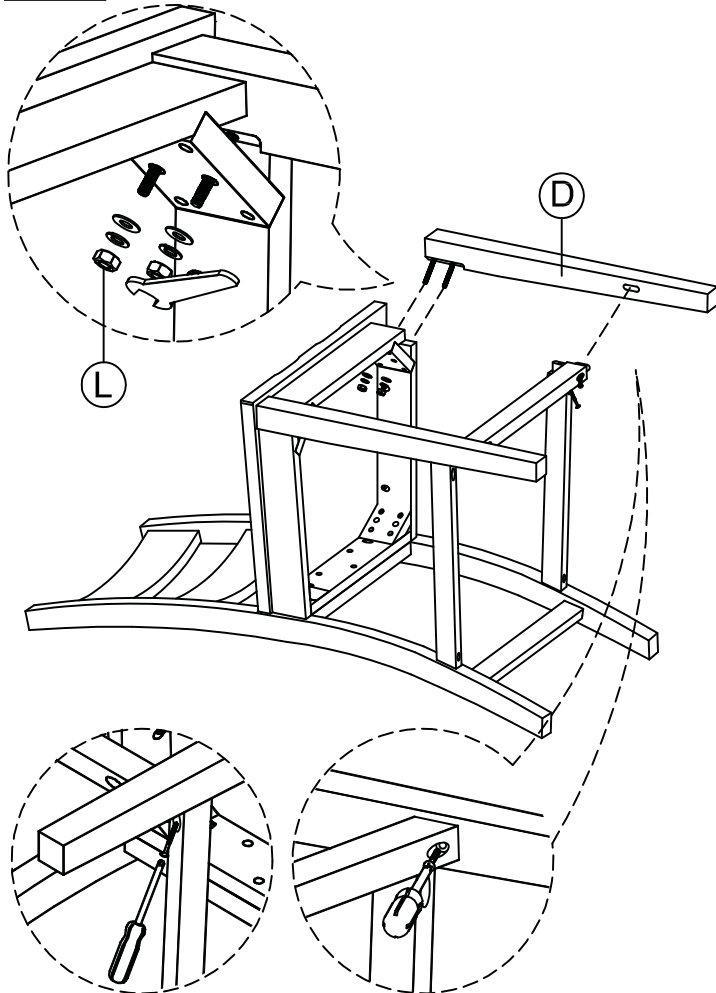

STEP 6

