

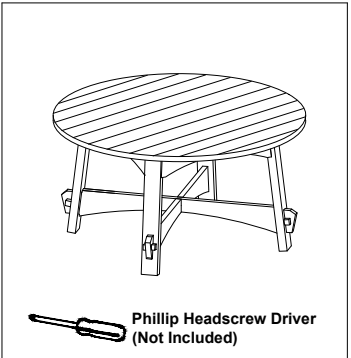

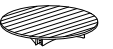

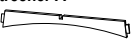

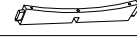



ASSEMBLY INSTRUCTION #1171



| NO | DESCRIPTION | QTY |
|----|--|-------|
| 1 | Top  | 1 Pc |
| 2A | Strecher A  | 1 Pc |
| 2B | Strecher B  | 1 Pc |
| 3 | Leg  | 4 Pcs |

HARDWARE LIST

| NO | SKETCH | HARDWARE | QTY |
|----|---|------------------------------|-------|
| A |  | Screw Ø8 x 50 | 4 Pcs |
| B |  | JCBC M6 x 50 + Spring Washer | 1 Pc |
| C |  | JCBC M8 x 50 | 8 Pcs |
| D |  | Spring Washer | 8 Pcs |
| E |  | Plat Washer | 8 Pcs |
| F |  | L key | 1 Pc |

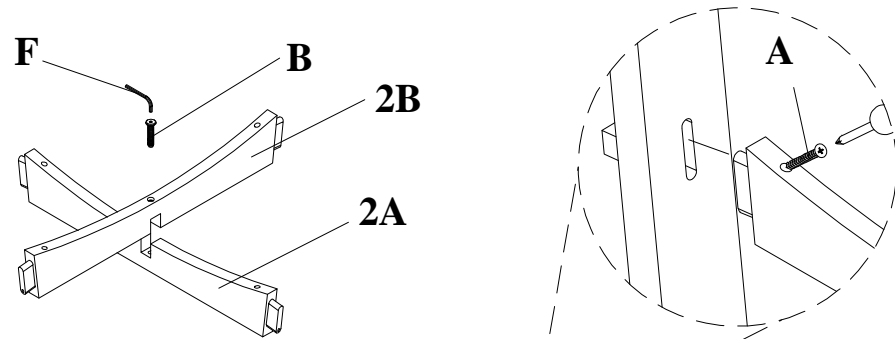

STEP 1

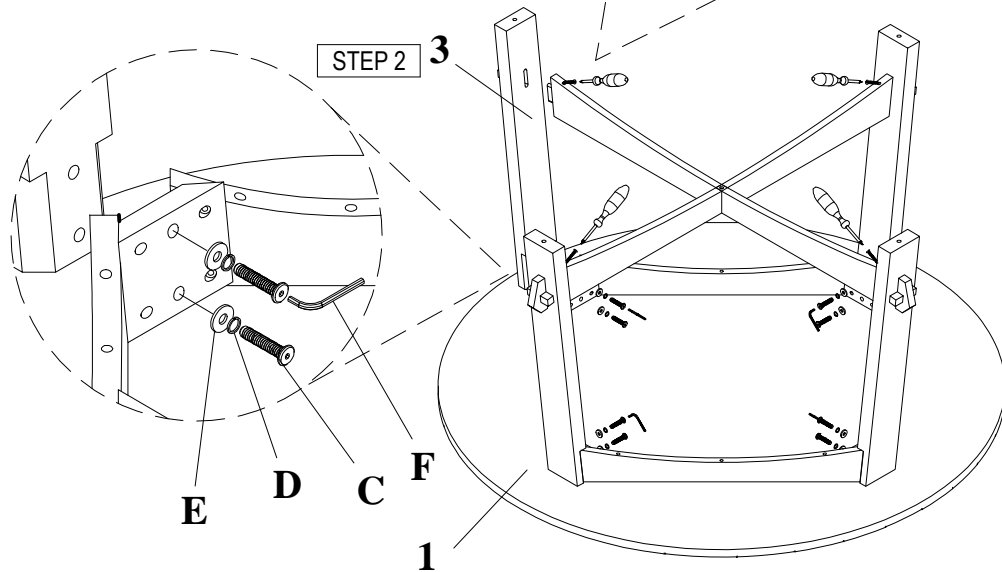



STEP 2



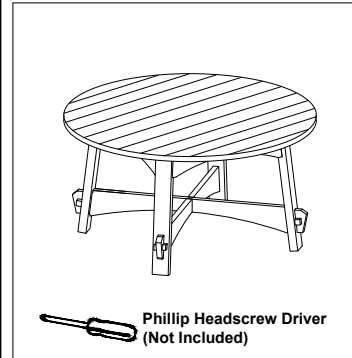

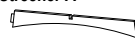



ASSEMBLY INSTRUCTION #1171



| NO | DESCRIPTION | QTY |
|----|--|-------|
| 1 | Top  | 1 Pc |
| 2A | Strecher A  | 1 Pc |
| 2B | Strecher B  | 1 Pc |
| 3 | Leg  | 4 Pcs |

HARDWARE LIST

| NO | SKETCH | HARDWARE | QTY |
|----|---|------------------------------|-------|
| A |  | Screw Ø8 x 50 | 4 Pcs |
| B |  | JCBC M6 x 50 + Spring Washer | 1 Pc |
| C |  | JCBC M8 x 50 | 8 Pcs |
| D |  | Spring Washer | 8 Pcs |
| E |  | Plat Washer | 8 Pcs |
| F |  | L key | 1 Pc |

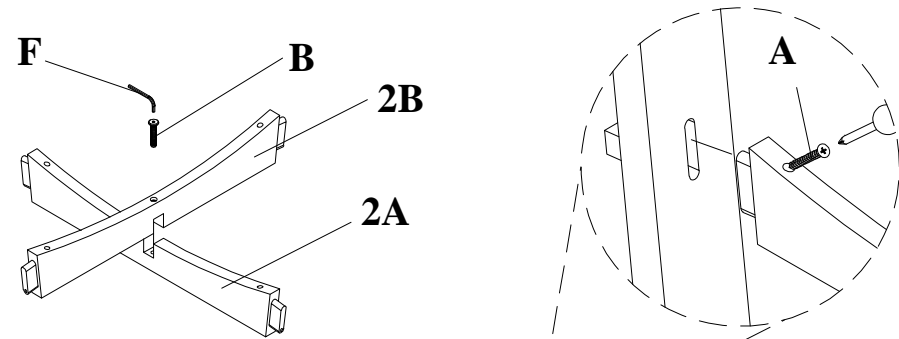

STEP 1

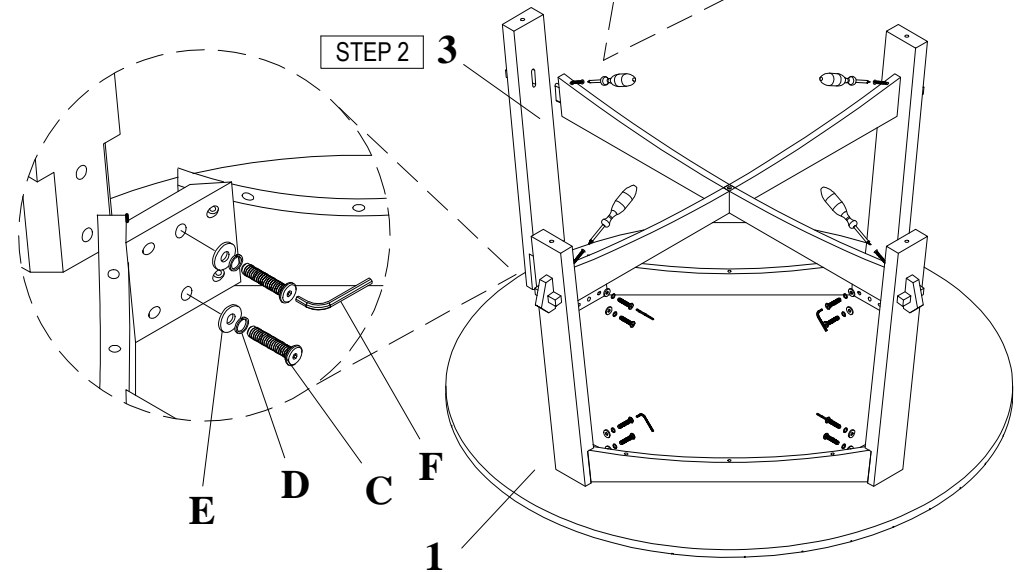

STEP 2